

Standoffs for Signage & Display

Easy Fasten

Easy to fasten to any surface, two piece construction enables the standoff barrel to be mounted using a hand drill. Intended for use in areas with minimal traffic.

Eco Lite	C-4	Acrylic Transparent	C-4
Eco Solid Barrels	C-5	Eco Aluminum	C-6
Euro Square	C-6	Euro Aluminum	C-7
Euro Mini	C-7	Eco Solid	C-11



Secure Fasten

Tamper resistant for added security, integrated set screws in the standoff cap easily tighten with a hex key. Modular construction allows for simple and quick installation with a hand drill.

Cone Topped	C-7	Premium Steel	C-8
Premium Steel X	C-9	Premium Stainless	C-9
Premium Aluminum	C-10		



Tamper Proof

Designed for ultimate tamper resistance in highly trafficked, unmonitored public areas. The cap simply cannot be loosened or removed by hand once the set screw is tightened into the body of the standoff. Easily mounts using a hand drill.

Eco Lock	C-5	Latte X	C-11
Shape	C-12	Euro Mini Stainless	C-12
Cubby	C-13	Low Profile	C-13
		Signage Screw Set	C-14



Edge It - No Drill

No need to drill panels or signs prior to mounting, this standoff has inlets between the cap and the barrel to allow the user to effortlessly install either single or multi panels as desired for temporary displays and artwork.

Eco Easy Edge	C-15	Eco 4Way	C-15
Easy Edge Premium	C-16	4 Way Premium	C-16



Standoffs for Signage & Display

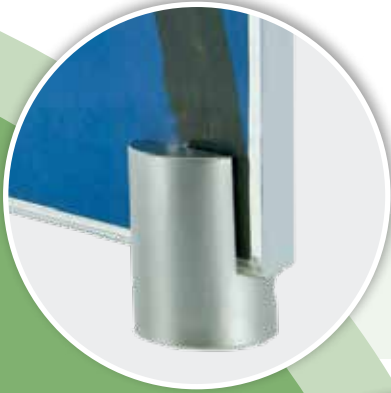

Grip It - No Drill

Great for vertical or horizontal applications, the novel slot in the body of the standoff can hold partition panels, signage or shelving of various thicknesses without any necessary modifications.

Slotted Standoffs	C-17	Signage Grips	C-17
Uno Clamp	C-18	Table Sign Clamp	C-18
Grip It Clamp- Illuminated	C-19	Grip It Clamp- Non-Illuminated	C-20



Cap It Off

All of the benefits of a conventional standoff with minimal projection, this standoff can be used to make "sandwich" style designs and meets ADA requirements.

Colorful Wall	C-21		
Eco Lite Wall Mount	C-21	Eco Wall Mount	C-21
Eco Solid Stainless Wall Mount	C-21	Premium Steel	C-22
Premium Aluminum	C-22	Button It	C-22

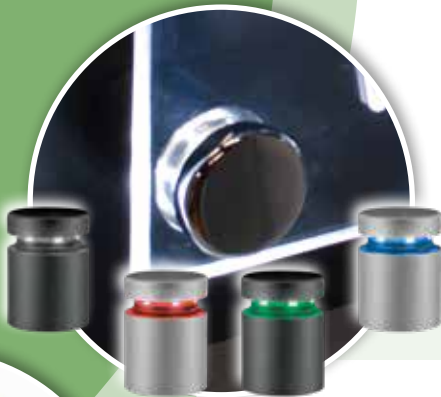

LED Standoff

Using LED's as a light source that are integrated in between the body of the standoff and its screw on flat cap, your mounted graphics, posters and promotional messages will come to life as never before in white, red, green or blue illumination. Sold in individual colors, the LED standoffs diffuse their light through the acrylic or plexiglass sign holders to which they have been fastened.

LED	C-23
-----	------



Invisi

Virtually invisible for maximum visibility of your promotional materials, Invisi standoffs easily mount from behind your piece without any vision obstructing surface mounting hardware to create a striking floating effect.

Crystal Round	C-24	Eco Invisible	C-24
Casper	C-24	Invisi Hang	C-25



for indoor & outdoor use



Easy mounting design

Eco Lite Series

MATERIAL = 202 Stainless Steel
FINISH = Brushed Stainless (BSS)

- 2 Part Assembly
- Lightweight hollow construction
- #6 flat head screws and drywall anchors included

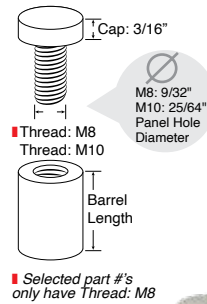

Finish:

(BSS)
Brushed Stainless

Selected part #'s only have Thread: M8

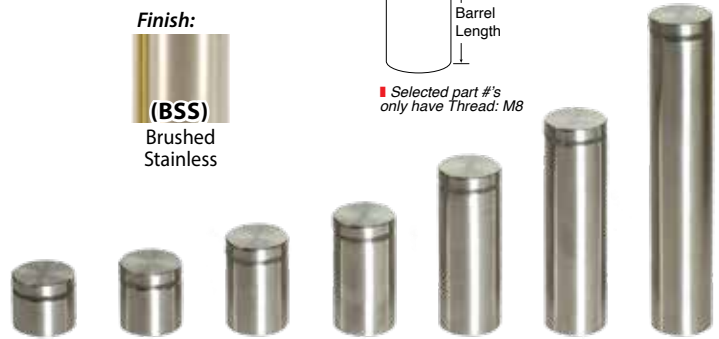

Part #	Panel Thickness	Barrel Length	Thread Length	Diameter
STDE-1313-BSS	Up to 1/4"	1/2"	1/2"	1/2"
STDE-1324-BSS	Up to 1/2"	3/4"	3/4"	1/2"
STDE-1332-BSS	Up to 1/2"	1"	3/4"	1/2"
STDE-1348-BSS	Up to 1/2"	1-1/2"	3/4"	1/2"
STDE-1364-BSS	Up to 1/2"	2"	3/4"	1/2"
STDE-1396-BSS	Up to 1/2"	3"	3/4"	1/2"
STDE-13128-BSS	Up to 1/2"	4"	3/4"	1/2"
STDE-2024-BSS	Up to 1/2"	3/4"	3/4"	5/8"
STDE-2032-BSS	Up to 1/2"	1"	3/4"	5/8"
STDE-2048-BSS	Up to 1/2"	1-1/2"	3/4"	5/8"
STDE-2064-BSS	Up to 1/2"	2"	3/4"	5/8"
STDE-2096-BSS	Up to 1/2"	3"	3/4"	5/8"
STDE-20128-BSS	Up to 1/2"	4"	3/4"	5/8"
STDE-2424-BSS	Up to 1/2"	3/4"	3/4"	3/4"
STDE-2432-BSS	Up to 1/2"	1"	3/4"	3/4"
STDE-2448-BSS	Up to 1/2"	1-1/2"	3/4"	3/4"
STDE-2464-BSS	Up to 1/2"	2"	3/4"	3/4"
STDE-2496-BSS	Up to 1/2"	3"	3/4"	3/4"
STDE-24128-BSS	Up to 1/2"	4"	3/4"	3/4"

Part #	Panel Thickness	Barrel Length	Thread Length	Diameter
STDE-3224-BSS	Up to 1/2"	3/4"	3/4"	1"
STDE-3232-BSS	Up to 1/2"	1"	3/4"	1"
STDE-3248-BSS	Up to 1/2"	1-1/2"	3/4"	1"
STDE-3264-BSS	Up to 1/2"	2"	3/4"	1"
STDE-3280-BSS	Up to 1/2"	2-1/2"	3/4"	1"
STDE-3296-BSS	Up to 1/2"	3"	3/4"	1"
STDE-32112-BSS	Up to 1/2"	3-1/2"	3/4"	1"
STDE-32128-BSS	Up to 1/2"	4"	3/4"	1"
STDE-32192-BSS	Up to 1/2"	6"	3/4"	1"
STDE-4024-BSS	Up to 1/2"	3/4"	3/4"	1-1/4"
STDE-4032-BSS	Up to 1/2"	1"	3/4"	1-1/4"
STDE-4048-BSS	Up to 1/2"	1-1/2"	3/4"	1-1/4"
STDE-4064-BSS	Up to 1/2"	2"	3/4"	1-1/4"
STDE-4096-BSS	Up to 1/2"	3"	3/4"	1-1/4"
STDE-40128-BSS	Up to 1/2"	4"	3/4"	1-1/4"
STDE-40192-BSS	Up to 1/2"	6"	3/4"	1-1/4"
STDE-4824-BSS	Up to 1/2"	3/4"	3/4"	1-1/2"
STDE-4832-BSS	Up to 1/2"	1"	3/4"	1-1/2"
STDE-4848-BSS	Up to 1/2"	1-1/2"	3/4"	1-1/2"
STDE-4864-BSS	Up to 1/2"	2"	3/4"	1-1/2"
STDE-4896-BSS	Up to 1/2"	3"	3/4"	1-1/2"
STDE-48128-BSS	Up to 1/2"	4"	3/4"	1-1/2"
STDE-48192-BSS	Up to 1/2"	6"	3/4"	1-1/2"

Clear Acrylic Transparent Standoffs



for indoor use only

MATERIAL = Acrylic
FINISH = Clear (CL)

- 2 Part Assembly
- Lightweight, durable construction
- Transparent acrylic
- #6 flat head screws and drywall anchors included

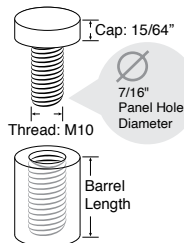

Part #	Panel Thickness	Barrel Length	Thread Length	Diameter
STDY-2424-CL	Up to 5/16"	3/4"	5/8"	3/4"
STDY-2432-CL	Up to 1/2"	1"	7/8"	3/4"
STDY-3232-CL	Up to 1/2"	1"	7/8"	1"



Please visit page C-26 for our wall anchor selections



Eco Lock Series

MATERIAL = 201 Stainless Steel
FINISHES = Polished Stainless (*PSS),
 Brushed Stainless (*BSS)

- 2 Part Assembly
- Medium weight construction
- 2mm Hex Key included (**One per order**)
- #6 flat head screws and drywall anchors included



Need Extra Hex Keys?
 2 mm Hex Key

STD-ALANKEY-2

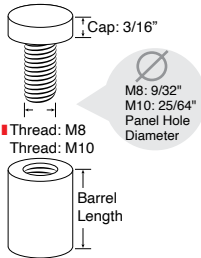

Finishes:



Selected part #'s only have Thread: M8

Part #	Panel Thickness	Barrel Length	Thread Length	Diameter
STDE-TM1313*	Up to 1/4"	1/2"	1/2"	1/2"
STDE-TM1324*	Up to 3/8"	3/4"	3/4"	1/2"
STDE-TM1332*	Up to 5/8"	1"	1"	1/2"
STDE-TM2024*	Up to 3/8"	3/4"	3/4"	5/8"
STDE-TM2032*	Up to 5/8"	1"	1"	5/8"
STDE-TM2424*	Up to 3/8"	3/4"	3/4"	3/4"
STDE-TM2432*	Up to 5/8"	1"	1"	3/4"
STDE-TM2448*	Up to 5/8"	1-1/2"	1"	3/4"
STDE-TM2464*	Up to 5/8"	2"	1"	3/4"

Part #	Panel Thickness	Barrel Length	Thread Length	Diameter
STDE-TM3224*	Up to 3/8"	3/4"	3/4"	1"
STDE-TM3232*	Up to 5/8"	1"	1"	1"
STDE-TM3248*	Up to 5/8"	1-1/2"	1"	1"
STDE-TM3264*	Up to 5/8"	2"	1"	1"
STDE-TM4024*	Up to 3/8"	3/4"	3/4"	1-1/4"
STDE-TM4032*	Up to 5/8"	1"	1"	1-1/4"
STDE-TM4048*	Up to 5/8"	1-1/2"	1"	1-1/4"
STDE-TM4064*	Up to 5/8"	2"	1"	1-1/4"



Eco Solid Barrels

MATERIAL = 201 Stainless Steel
FINISH = Brushed Stainless

- Must be used with 1" diameter "Eco Lock Series" standoffs **STDE-TM32***
- 2 Part Assembly
- Medium weight construction
- Ideal for layering signage designs



Part #	Panel Thickness	Barrel Length	Thread Length	Diameter
STDE-32BAR-1	Up to 3/4"	1"	1"	1"
STDE-64BAR-1	Up to 3/4"	2"	1"	1"
STDE-96BAR-1	Up to 3/4"	3"	1"	1"
STDE-32BAR-2	Up to 1"	1"	1-1/2"	1"
STDE-64BAR-2	Up to 1"	2"	1-1/2"	1"
STDE-96BAR-2	Up to 1"	3"	1-1/2"	1"

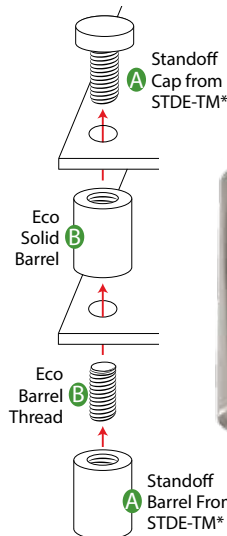

Easy Fasten Standoffs



Eco Aluminum Standoffs

New 1-1/2" & 2" Barrel Length

MATERIAL = Aluminum

FINISHES = Cherry Red (*RD), Purple (*PL), Rosy Pink (*RP), Steel Grey (*SG), Champagne Brown (*BR), Copper (*CP), Blue (*BL), Black (*BK), Gold (*GD), Green (*GN), Silver (*SL)

- 2 Part Assembly
- Lightweight, durable aluminum construction
- #6 flat head screws and drywall anchors included

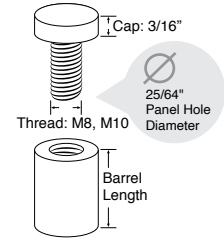

Finishes:

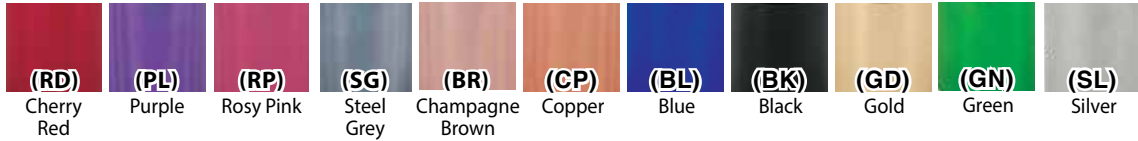

Part #	Panel Thickness	Barrel Length	Thread Length	Thread Size	Thread Diameter
● STDE-A1313 *	Up to 1/4"	1/2"	1/2"	M8	1/2"
■ STDE-A1324 *	Up to 3/8"	3/4"	3/4"	M8	1/2"
▲ STDE-A2424 *	Up to 3/8"	3/4"	3/4"	M10	3/4"
◆ STDE-A2432 *	Up to 1/2"	1"	3/4"	M10	3/4"

- **STDE-A1313 is not available in Steel Grey (SG)**
- **STDE-A1324 is not available in Copper (CP)**
- ◆ **STDE-A2432 is not available in Blue (BL)**

Part #	Panel Thickness	Barrel Length	Thread Length	Thread Size	Thread Diameter
■ STDE-A3224 *	Up to 3/8"	3/4"	3/4"	M10	1"
▲ STDE-A3232 *	Up to 1/2"	1"	3/4"	M10	1"
▲ STDE-A3248 *	Up to 1/2"	1-1/2"	3/4"	M10	1"
■ STDE-A3264 *	Up to 1/2"	2"	3/4"	M10	1"

- **STDE-A3224 is not available in Blue (BL)**
- ▲ **STDE-A3248 is not available in Champagne Brown (BR)**



Euro Square Standoffs



MATERIAL = Solid Carbon Steel or Aluminum

FINISHES = Polished Chrome (PC), Matte Chrome (MC), Aluminum (ALU)

- 2 Part Assembly
- Heavyweight, durable steel construction
- Modern look complements any design
- #6 flat head screws and drywall anchors included

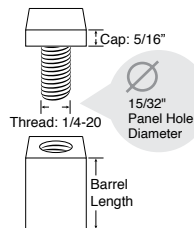

Part #	Panel Thickness	Barrel Length	Thread Length	Cap Size
STD-SQ2424-MC	Up to 1/2"	3/4"	3/4"	3/4" sq.
STD-SQ2432-ALU	Up to 1/2"	1"	3/4"	3/4" sq.
STD-SQ2464-PC	Up to 1"	2"	1-1/2"	3/4" sq.
STD-SQ2464-MC	Up to 1"	2"	1-1/2"	3/4" sq.
STD-SQ4024-PC	Up to 1/2"	3/4"	3/4"	1-1/4" sq.
STD-SQ4024-MC	Up to 1/2"	3/4"	3/4"	1-1/4" sq.
STD-SQ4024-ALU	Up to 1/2"	3/4"	3/4"	1-1/4" sq.
STD-SQ4032-PC	Up to 1/2"	1"	3/4"	1-1/4" sq.
STD-SQ4032-MC	Up to 1/2"	1"	3/4"	1-1/4" sq.
STD-SQ4032-ALU	Up to 1/2"	1"	3/4"	1-1/4" sq.
STD-SQ4064-PC	Up to 1"	2"	1-1/2"	1-1/4" sq.
STD-SQ4064-MC	Up to 1"	2"	1-1/2"	1-1/4" sq.
STD-SQ4064-ALU	Up to 1"	2"	1-1/2"	1-1/4" sq.

Finishes:

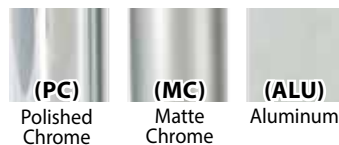

Please visit page C-26 for our wall anchor selections

Euro Mini Series



MATERIAL = Solid Carbon Steel
FINISHES = Polished Chrome (PC),
 Matte Chrome (MC)

- 2 Part Assembly
- Lightweight, durable steel construction
- Euro Style
- #6 flat head screws and drywall anchors included

Finishes:

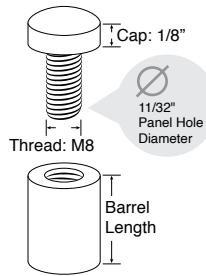
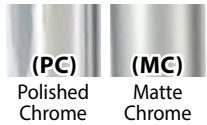

Part #	Panel Thickness	Barrel Length	Thread Length	Diameter
STD-1313-PC	Up to 3/16"	1/2"	5/16"	1/2"
STD-1313-MC	Up to 3/16"	1/2"	5/16"	1/2"
STD-1319-PC	Up to 5/16"	3/4"	1/2"	1/2"
STD-1319-MC	Up to 5/16"	3/4"	1/2"	1/2"

Euro Aluminum Standoffs



MATERIAL = Aluminum
FINISH = Silver Anodized (SIL)

- 2 Part Assembly
- #6 flat head screws and drywall anchors included

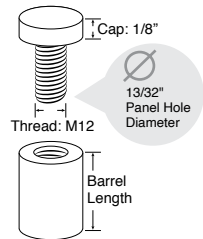

Part #	Panel Thickness	Barrel Length	Diameter
STD-MH3264-SIL	Up to 1"	2"	1"

Secure Fasten Standoffs

Cone Topped Standoffs



MATERIAL = Carbon Steel
FINISH = Polished Chrome (PC)

- 2 Part Assembly
- Medium weight, durable steel construction
- Modern look complements any design
- 2.5mm Hex Key included (One per order)
- #6 flat head screws and drywall anchors included

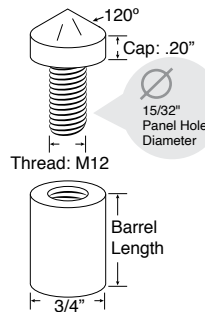

Part #	Panel Thickness	Barrel Length	Thread Length	Diameter
STD-C2424-PC	Up to 3/8"	3/4"	3/4"	3/4"
STD-C2432-PC	Up to 1/2"	1"	3/4"	3/4"
STD-C2448-PC	Up to 3/4"	1-1/2"	1"	3/4"
STD-C2464-PC	Up to 3/4"	2"	1"	3/4"
STD-C24128-PC	Up to 1"	4"	1-1/4"	3/4"

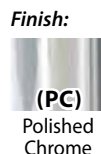

Please visit page C-26 for our wall anchor selections

Need Extra Hex Keys?
 2.5mm Hex Key
STD-ALANKEY



for indoor use only

Premium Steel Series

MATERIAL = Solid Carbon Steel

FINISHES = Polished Chrome (*PC), Matte Chrome (*MC), Black Nickel (*BN), Bright Brass (*BB), Brushed Stainless (*BSS), Satin Copper (*SC), Oil Rubbed Bronze (*ORB)

- 3 Part Assembly
- Medium weight construction
- 2.5mm Hex Key included (One per order)
- #6 flat head screws and drywall anchors included



Finishes:

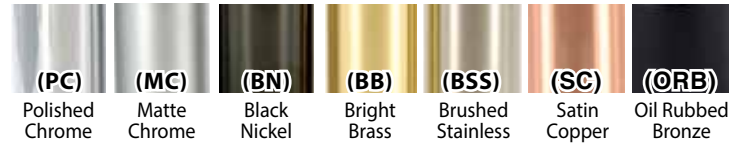

See page C-22 for Caps

Part #	Panel Thickness	Barrel Length	Thread Length	Diameter	Finish
STD-2424-*	Up to 1/2"	3/4"	3/4" and 1"	3/4"	(*PC) (*MC) (*BN) (*BB) (*BSS) (*SC) (*PC) (*MC) (*BN) (*BB) (*BSS) (*SC) (*ORB)
STD-2432-*	Up to 1/2"	1"	1"	3/4"	(*PC) (*MC) (*BN) (*BB) (*BSS) (*SC) (*ORB)
STD-2448-*	Up to 1/2"	1-1/2"	1"	3/4"	(*PC) (*MC) (*BN) (*BB) (*BSS) (*ORB)
STD-24128-*	Up to 1/2"	4"	1"	3/4"	(*PC) (*MC) (*BN) (*BB) (*BSS) (*ORB)

Part #	Panel Thickness	Barrel Length	Thread Length	Diameter	Finish
STD-4024-*	Up to 1/2"	3/4"	3/4" and 1"	1-1/4"	(*PC) (*MC) (*BN) (*BB) (*BSS) (*PC) (*MC)
STD-4032-*	Up to 1/2"	1"	1"	1-1/4"	(*BN) (*BB) (*BSS) (*PC) (*MC)
STD-4048-*	Up to 1/2"	1-1/2"	1"	1-1/4"	(*BB) (*ORB) (*PC) (*MC)
STD-40128-*	Up to 1/2"	4"	1"	1-1/4"	(*BN) (*BB) (*BSS) (*PC) (*MC)
STD-40192-*	Up to 1/2"	6"	1"	1-1/4"	(*MC) (*BSS)



Please visit page C-26 for our wall anchor selections

Need Extra Hex Keys?

2.5mm Hex Key

STD-ALANKEY

Premium Steel X Series



for indoor use only

Secure Fasten Standoffs

MATERIAL = Carbon Steel

FINISH = Polished Chrome (*PC), Matte Chrome (*MC), Black Nickel (*BN), Bright Brass (*BB), Brushed Stainless (*BSS), Oil Rubbed Bronze (*ORB)

- 3 Part Assembly
- Medium weight construction
- Holds thicker panels (longer cap thread)
- Includes both 1" & 1-1/2" cap threads
- 2.5mm Hex Key included **(One per order)**
- #6 flat head screws and drywall anchors included

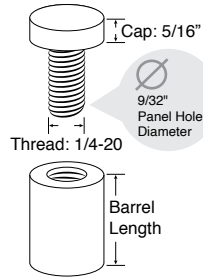

Finishes:

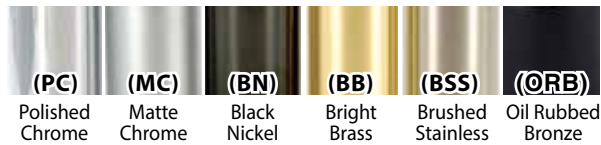

Part #	Panel Thickness	Barrel Length	Thread Length	Diameter
STD-LG2448*	Up to 3/4"	1-1/2"	1" & 1-1/2"	3/4"
STD-LG24128*	Up to 3/4"	4"	1" & 1-1/2"	3/4"
STD-LG4048*	Up to 3/4"	▲1-1/2"	1" & 1-1/2"	1-1/4"
STD-LG40128*	Up to 3/4"	●4"	1" & 1-1/2"	1-1/4"
STD-LG40192*	Up to 3/4"	■6"	1" & 1-1/2"	1-1/4"

- ▲ 1-1/2" Not Available in BN & BSS
- 4" Not Available in ORB
- 6" Available in MC or BSS only



Need Extra Hex Keys?
2.5mm Hex Key

STD-ALANKEY

Premium Stainless Series



for indoor & outdoor use

MATERIAL = 316 Stainless Steel

FINISH = Satin Stainless (SS)

- 3 Part Assembly
- Medium weight construction
- Marine grade - Will not rust!
- 2.5mm Hex Key included **(One per order)**
- #6 flat head screws and drywall anchors included

Marine grade - Will not rust!

Finish:

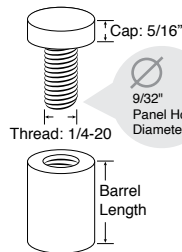

Part #	Panel Thickness	Barrel Length	Thread Length	Diameter
STD-2424-SS	Up to 1/2"	3/4"	1"	3/4"
STD-2432-SS	Up to 1/2"	1"	1"	3/4"
STD-2448-SS	Up to 1/2"	1-1/2"	1"	3/4"
STD-24128-SS	Up to 1/2"	4"	1"	3/4"
STD-4024-SS	Up to 1/2"	3/4"	1"	1-1/4"
STD-4032-SS	Up to 1/2"	1"	1"	1-1/4"
STD-4048-SS	Up to 1/2"	1-1/2"	1"	1-1/4"
STD-40128-SS	Up to 1/2"	4"	1"	1-1/4"



Need Extra Hex Keys?
2.5mm Hex Key

STD-ALANKEY



Please visit page C-26 for our wall anchor selections

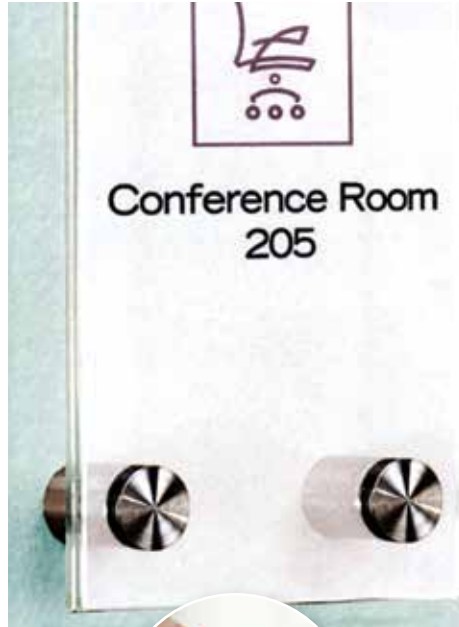

Premium Aluminum Series

MATERIAL = Aluminum
FINISHES = Polished Chrome (*PC),
 Satin Stainless (*SS)

- 3 Part Assembly
- Lightweight, durable aluminum construction
- Will not rust!
- Flat Cap - 1/4-20 thread
- 2.5mm Hex Key included (**One per order**)
- #6 flat head screws and drywall anchors included

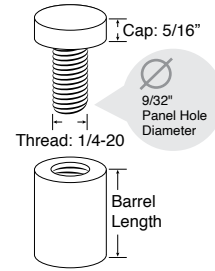

Finishes:

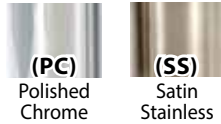

Need Extra Hex Keys?
 2.5mm Hex Key
STD-ALANKEY



Part #	Panel Thickness	Barrel Length	Thread Length	Diameter
STDA-2020-SS	Up to 3/8"	5/8"	3/4"	5/8"
STDA-2032-SS	Up to 1/2"	1"	1"	5/8"
STDA-2048-SS	Up to 1/2"	1-1/2"	1"	5/8"
STDA-2064-SS	Up to 1/2"	2"	1"	5/8"
STDA-2096-SS	Up to 1/2"	3"	1"	5/8"
STDA-20128-SS	Up to 1/2"	4"	1"	5/8"
STDA-2424-*	Up to 1/2"	3/4"	3/4"-1"	3/4"
STDA-2432-*	Up to 1/2"	1"	1"	3/4"
STDA-2448-*	Up to 1/2"	1-1/2"	1"	3/4"
STDA-24128-*	Up to 1/2"	4"	1"	3/4"
STDA-4024-*	Up to 1/2"	3/4"	1"	1-1/4"
STDA-4032-*	Up to 1/2"	1"	1"	1-1/4"
STDA-4048-SS	Up to 1/2"	1-1/2"	1"	1-1/4"
STDA-40128-*	Up to 1/2"	4"	1"	1-1/4"



Eco Solid Series

for indoor & outdoor use

MATERIAL = 201 Stainless Steel
FINISHES = Polished Stainless (*PSS)
 Brushed Stainless (*BSS)

- 2 Part Assembly
- Medium weight construction
- #6 flat head screws and drywall anchors included

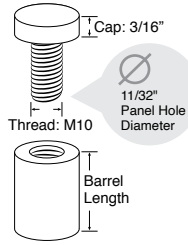

Finishes:



Part #	Panel Thickness	Barrel Length	Diameter
STDE-S4048-*	Up to 5/8"	1-1/2"	1-1/4"
STDE-S4064-PSS	Up to 5/8"	2"	1-1/4"



Please visit page C-26 for our wall anchor selections



Easy mounting design



Latte X Standoffs

for indoor use only

MATERIAL = Die Cast Zamac
FINISHES = Polished Chrome (*PC), Matte Chrome (*MC),
 Bright Brass (*BB), Satin Copper (*SC),
 Brushed Stainless (*BSS), Antique Brass (*AB)

- 2 Part Assembly
- Medium weight, durable construction
- Euro style round cap pops into place inside barrel
- 2mm Hex Key included (**One per order**)
- #6 flat head screws and drywall anchors included

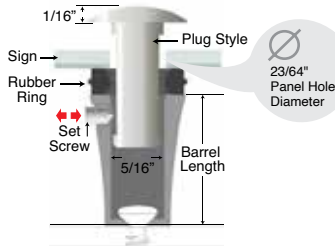

Part #	Panel Thickness	Barrel Length	Diameter
STD-D1828-*	Up to 1/2"	13/16"	9/16"



Please visit page C-26 for our wall anchor selections

Need Extra Hex Keys?
 2 mm Hex Key

STD-ALANKEY-2





for indoor use only

Shape Series

MATERIAL = Die Cast Zinc

FINISHES = Polished Chrome (*PC), Matte Chrome (*MC),
Bright Brass (*BB), Satin Copper (*SC),
Brushed Stainless (*BSS), Antique Brass (*AB)

- 2 Part Assembly
- Medium weight construction
- Unique and special shape designs
- Plug system with tamper proof set screw
- 2mm Hex Key included (**One Per Order**)
- #6 flat head screws and drywall anchors included

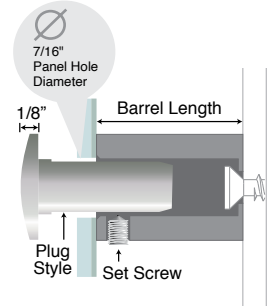

Part #	Panel Thickness	Barrel Length	Diameter
STD-3C2126*	Up to 7/16"	13/16"	5/8"
STD-4C1826*	Up to 7/16"	13/16"	9/16"
STD-6C1826*	Up to 7/16"	13/16"	9/16"

Need Extra Hex Keys?

2 mm Hex Key

STD-ALANKEY-2



Euro Mini Stainless Standoffs



for indoor & outdoor use

MATERIAL = 304 Stainless

FINISH = Brushed Stainless (**BSS**)

- 2 Part Assembly
- Lightweight construction
- 1.5mm Hex Key included (**One Per Order**)
- #6 flat head screws and drywall anchors included

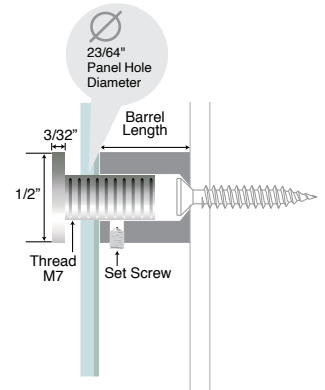

Finish:



(BSS)
Brushed
Stainless

Part #	Panel Thickness	Barrel Length	Diameter
STD-TMS1313-BSS	Up to 3/8"	1/2"	1/2"

Need Extra Hex Keys?

1.5mm Hex Key

STD-ALANKEY-1



Please visit page C-26 for our wall anchor selections



Cubby Series

MATERIAL = Die Cast Zinc
FINISH = Brushed Nickel (BHN)

- 2 Part Assembly
- Medium weight construction
- Smooth even head blends with panels
- Tamper proof plug thread stops head from moving
- 2mm Hex Key included (**One per order**)
- #6 flat head screws and drywall anchors included

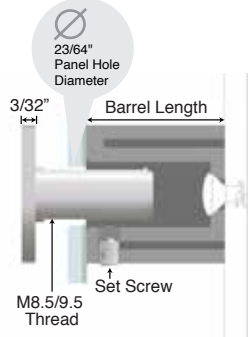

Part #	Panel Thickness	Barrel Length	Diameter
STD-CBX24-BHN	Up to 3/8"	3/4"	3/4"

Finish:

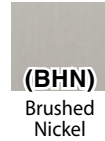

Need Extra Hex Keys?
2 mm Hex Key

STD-ALANKEY-2



Low Profile Tamper Proof

MATERIAL = Solid Brass
FINISH = Polished Stainless (PSS)
Brushed Stainless (BSS)

- 2 Part Assembly
- Medium weight construction
- 2mm Hex Key included (**One per order**)
- #6 flat head screws and drywall anchors included

Part #	Panel Thickness	Barrel Length	Diameter
STDL-2032-PSS	Up to 1/2"	1"	5/8"
STDL-2032-BSS	Up to 1/2"	1"	5/8"
STDL-3232-PSS	Up to 1/2"	1"	1"

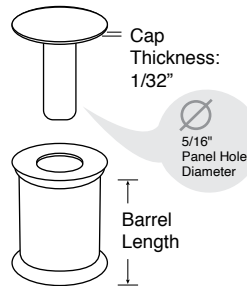

Need Extra Hex Keys?
2 mm Hex Key

STD-ALANKEY-2



Please visit page C-26 for our wall anchor selections

New

Tamper Proof Signage Screw Set



MATERIAL = 316 Stainless Steel
FINISH = Polished Stainless

- Tamper Proof
- 316 Stainless for outdoor use
- Holds panels up to 9/16"
- **Set includes:**
4-Stainless Steel Studs,
Torx Screws,
Drywall Anchors
1-Torx Key
(Extra keys sold separately)



STD-TMCAP-SS

Tamper Proof Signage Screw Kit
(Set of 4)

Need Extra Torx Keys?



STD-TM-TORX

T20 Torx Key
for Tamper Proof
Signage Screws

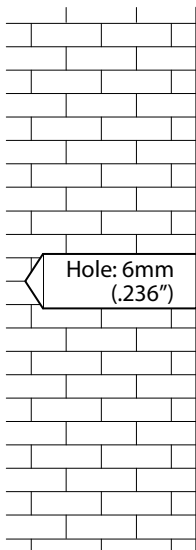

Hole: 6mm
(.236")

Panel Thickness: 1~15mm
(.039"~.591")

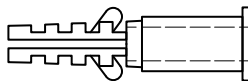

Panel Hole: 5mm
(.197")

Spacer: 3mm
(.118")

Dia: 15mm
(.591")

Bottom Hole: 4.2mm
(.165")

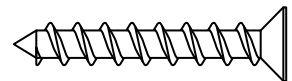

Please visit page
C-26 for our wall
anchor selections



Edge Grip: Eco Easy Edge Standoffs

MATERIAL = 201 Stainless Steel
FINISH = Brushed Stainless (BSS)

- Lightweight construction
- Ideal for one panel
- 2mm Hex Key included (**One per order**)
- #6 flat head screws and drywall anchors included for 5/8" & 3/4" diameter

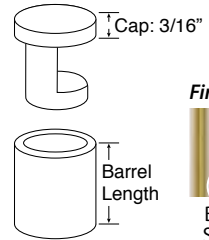

Finish:
(BSS)
Brushed
Stainless

Part #	Panel Thickness	Barrel Length	Diameter
STDE-ED1313-BSS	Up to 1/2"	1/2"	1/2"
STDE-ED1324-BSS	Up to 1/2"	3/4"	1/2"
STDE-ED1332-BSS	Up to 1/2"	1"	1/2"
STDE-ED1348-BSS	Up to 1/2"	1-1/2"	1/2"
STDE-ED2024-BSS	Up to 1/2"	3/4"	5/8"
STDE-ED2032-BSS	Up to 1/2"	1"	5/8"
STDE-ED2048-BSS	Up to 1/2"	1-1/2"	5/8"
STDE-ED2432-BSS	Up to 1/2"	1"	3/4"
STDE-ED2448-BSS	Up to 1/2"	1-1/2"	3/4"

■ Screws & anchors not included

Need Extra Hex Keys?

2mm Hex Key

STD-ALANKEY-2



Please visit page
C-26 for our wall
anchor selections



Edge Grip: Eco 4 Way Series



MATERIAL = 201 Stainless Steel & Aluminum
FINISHES = Polished Stainless (PSS), Brushed Stainless (BSS)

- Lightweight construction
- Ideal for up to 4 panels
- No drilling required
- Will hold multiple signs
- 2.5mm Hex Key included (**One per order**)
- #6 flat head screws and drywall anchors included
- Tamper proof

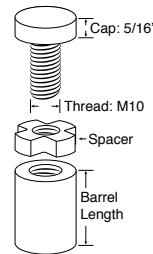

Part #	Panel Thickness	Barrel Length	Diameter
STDE-SP-3224-PSS	Up to 5/16"	3/4"	1"
STDE-SP-3224-BSS	Up to 5/16"	3/4"	1"
STDE-SP-3232-PSS	Up to 5/16"	1"	1"
STDE-SP-3232-BSS	Up to 5/16"	1"	1"
STDE-SP-3248-PSS	Up to 5/16"	1-1/2"	1"
STDE-SP-3248-BSS	Up to 5/16"	1-1/2"	1"
STDE-SP-3264-PSS	Up to 5/16"	2"	1"
STDE-SP-3264-BSS	Up to 5/16"	2"	1"

Need Extra Hex Keys?

2.5mm Hex Key

STD-ALANKEY

Finishes:



Please visit page
C-26 for our wall
anchor selections



Edge Grip: Easy Edge Premium Series

MATERIAL = Solid Carbon Steel
FINISHES = Polished Chrome (PC), Matte Chrome (MC)

- Medium weight, durable steel construction
- Ideal for one panel
- 2mm Hex Key included (**One per order**)
- #6 flat head screws and drywall anchors included

Part #	Panel Thickness	Barrel Length	Diameter
STD-EDGE-PC	Up to 1/2"	1"	1"
STD-EDGE-MC	Up to 1/2"	1"	1"

Finishes:

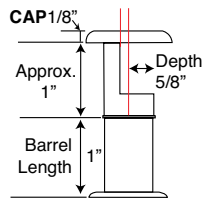
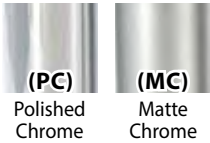

Need Extra Hex Keys?
 2 mm Hex Key
STD-ALANKEY-2

Edge Grip: 4 Way Premium Series



MATERIAL = Solid Carbon Steel
FINISHES = Polished Chrome (PC), Matte Chrome (MC)

- Medium weight, durable steel construction
- Ideal for up to 4 panels
- 2.5mm Hex Key included (**One per order**)
- #6 flat head screws and drywall anchors included

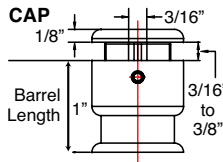
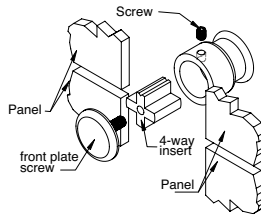

Part #	Panel Thickness	Barrel Length	Diameter
STD-4WAY-PC	Up to 5/16"	1"	1"
STD-4WAY-MC	Up to 5/16"	1"	1"

Finishes:

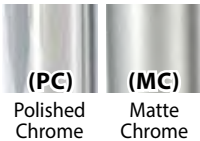

Need Extra Hex Keys?
 2.5mm Hex Key
STD-ALANKEY

 Please visit page C-26 for our wall anchor selections



Horizontal

Vertical



Slotted Standoffs

MATERIAL = Solid Brass

FINISHES = Polished Chrome (PC), Matte Chrome (MC)

- Can be mounted either vertically or horizontally
- Perfect for holding partition panels, signage or shelving
- No drilling required
- Hex key to tighten
- 2.5mm Hex Key included (**One per order**)
- 1-1/2" L x 5/16" Hanger Bolt included
- Maximum Load Rating: 17 lbs.

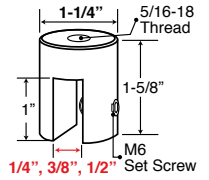

Finishes:



Part #	Panel Thickness	Barrel Length	Diameter
STD-SL14-PC	Up to 1/4"	1-5/8"	1-1/4"
STD-SL14-MC	Up to 1/4"	1-5/8"	1-1/4"
STD-SL38-PC	Up to 3/8"	1-5/8"	1-1/4"
STD-SL38-MC	Up to 3/8"	1-5/8"	1-1/4"
STD-SL12-PC	Up to 1/2"	1-5/8"	1-1/4"
STD-SL12-MC	Up to 1/2"	1-5/8"	1-1/4"

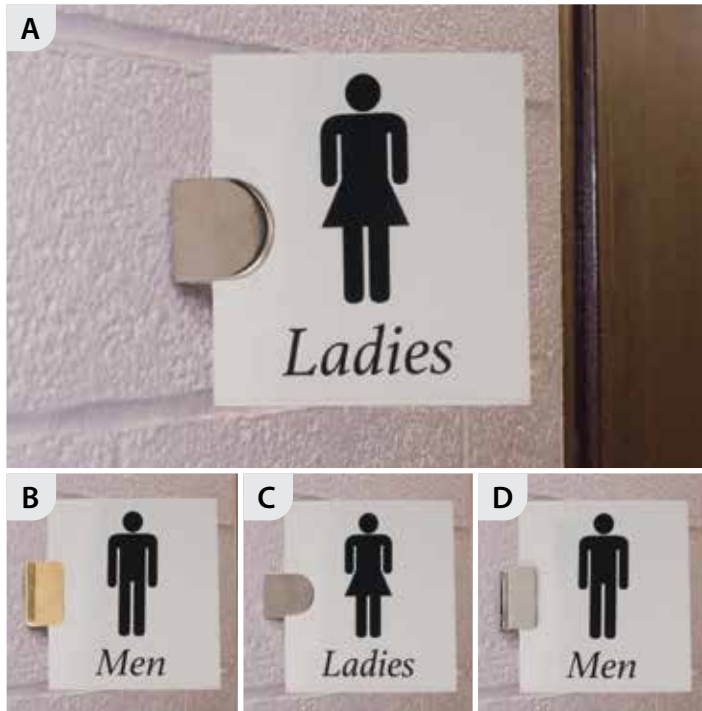

Signage Grips



- Rubber pads included to adjust for different panel thickness
- #6 screw and anchor included

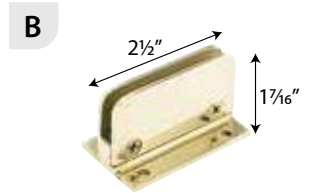

- 4 Screws included

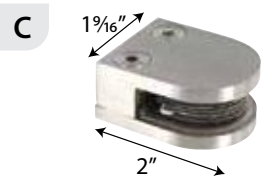

- Rubber pads included to adjust for different panel thickness
- #6 screw and anchor included

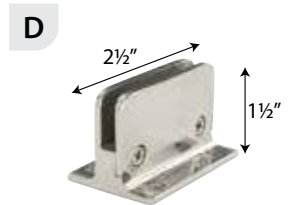

- 4 Screws included

	Part #	Panel Thickness	Finish	Material
A	SSFZ-618F-SC	3/16" - 3/8"	Brushed Stainless Steel	Zamac
B	S83-108F-BR	1/4"	Polished Brass	Brass
C	SSF-618FADJ-SC	1/4" - 3/8"	Brushed Stainless Steel	304 Grade Satin Stainless Steel
D	S83-108F-CH	1/4"	Polished Stainless Steel	Stainless Steel



Please visit page C-26 for our wall anchor selections

Need Extra Hex Keys?

2.5mm Hex Key

STD-ALANKEY

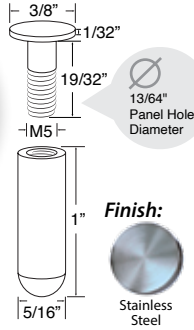

Table Sign Clamp

MATERIAL = 304 Grade Stainless Steel

FINISHES = Stainless Steel (SS)

- Perfect for nameplates and small desktop signs
- Sleek modern look
- Quality stainless steel construction



Part #	Panel Thickness	Barrel Length
STD-D32-SS	Up to 5/6"	1"





Grip It Clamp Illuminated

12V
MATERIAL = Clear Anodized Aluminum
FINISH = Matte Chrome (MC)

- 2mm Hex Key included
(one per order)
- #6 flat head screws and drywall anchors included
- No drilling required
- The clamp wire is 38" long

Lighting Specifications

Color Temperature	CW: 6000K-6500K
Beam Spread	120°
Lumens	CW: 40-80
Color Rendering Index	CW: 70
Rated Average Life	CW: 50,000 hrs.
Chip Size	SMD3528



Part #	Color Temp	Panel Thickness	▲ Maximum Sign Size	Length	# Of LED Chips	Total Wattage
LED-SC80-MC	Cool White	3/16" - 5/16"	4-3/4" x 6-5/16"	3-1/8"	6	.4W
LED-SC120-MC		3/16" - 5/16"	7-1/16" x 7-7/8"	4-3/4"	9	.6W
LED-SC180-MC		3/16" - 5/16"	8-5/8" x 9-1/2"	7-1/16"	12	.8W

▲ Maximum sign size per piece



Please visit page C-26 for our wall anchor selections

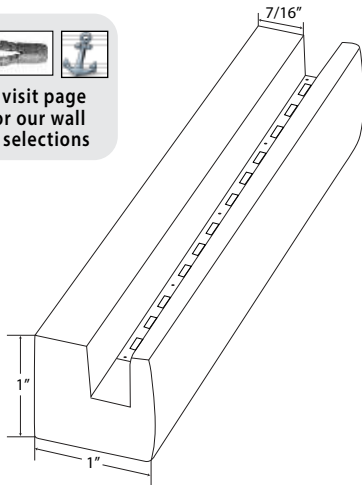

Finish:



(MC)
Matte Chrome

Power Supplies (Required)

LED-SC-TR-1A



2.91"L x 1.61"W x 1.14"H
 1A / 12V / 12W
 Input Cord: 5'
 Color: Black

Junction Box (Required)

Function: Is to join multiple fixtures to one power supply.



LED-STD-JB10

2"L x 1-1/4"W x 1/2"D
Number of Outputs: 10
 Input Cord: 19-11/16"
 Color: White



Grip It Clamp
Non-Illuminated



for indoor use only

MATERIAL = Clear Anodized Aluminum
FINISHES = Polished Chrome (*PC)
Matte Chrome (*MC)

- 2mm Hex Key included (**one per order**)
- #6 flat head screws and drywall anchors included
- No drilling required

Kit Includes:

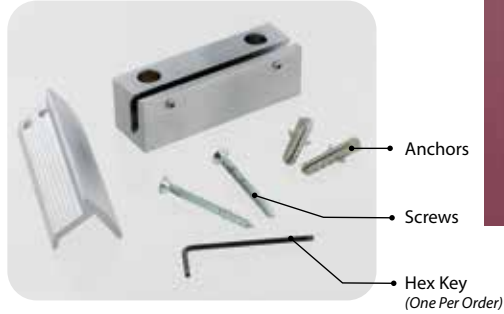

Part #	Panel Thickness	Length	▲ Maximum Sign Size
SC-80-*	1/8" - 1/2"	3-1/8"	4-3/4" x 6-5/16"
SC-120-*	1/8" - 1/2"	4-3/4"	7-1/16" x 7-7/8"
SC-180-*	1/8" - 1/2"	7-1/16"	8-5/8" x 9-1/2"

▲ Maximum sign size per piece

Finishes:

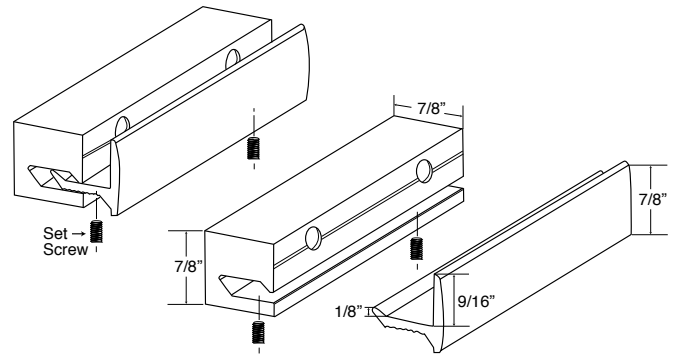
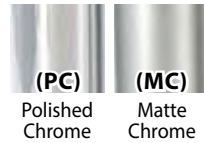

Please visit page C-26 for our wall anchor selections



Colorful Wall

MATERIAL = Polypropylene

- Sold in sets of 4. Each Kit includes 4 caps, 4 bases, 4 #6 x 1" screws & 4 anchors
- All caps are made from polypropylene
- All metallic finishes are vacuum plated
- Polypropylene caps are UV stabilized for outdoor use (does not apply to metallics)

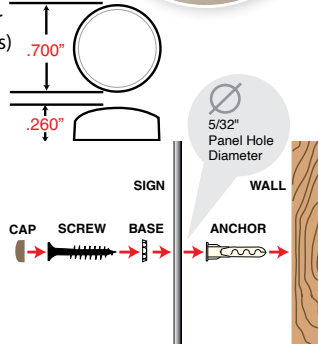

W While Supplies Last

Part #	Diameter	Finish	Part #	Diameter	Finish	Part #	Diameter	Finish	Part #	Diameter	Finish
STDC-24-BK	11/16"	Black	STDC-24-GR	11/16"	Green	STDC-24-LP	11/16"	Light Pink	STDC-24-SC	11/16"	Satin Chrome
STDC-24-WH	11/16"	White	STDC-24-BL	11/16"	Blue	STDC-24-RD	11/16"	Red	STDC-24-CH	11/16"	Bright Chrome
STDC-24-BR	11/16"	Brown	STDC-24-OR	11/16"	Orange	STDC-24-TQ	11/16"	Turquoise	STDC-24-BRS	11/16"	Bright Brass
STDC-24-BE	11/16"	Beige	STDC-24-PL	11/16"	Purple	STDC-24-YW	11/16"	Yellow	STDC-24-SCOP	11/16"	Satin Copper
STDC-24-LG	11/16"	Light Gray	STDC-24-DB	11/16"	Dark Blue	STDC-24-FG	11/16"	Forest Green	STDC-24-COP	11/16"	Bright Copper

Eco Lite Wall Mount



MATERIAL = 202 Stainless Steel
FINISH = Brushed Stainless (BSS)



Part #	Diameter
STD-32AMC-BSS	1"
STD-48AMC-BSS	1-1/2"

Finish:
(BSS)
Brushed Stainless

Eco Wall Mount Signage Caps



MATERIAL = 201 Stainless Steel
FINISHES = Brushed Stainless (BSS)
Polished Stainless (PSS)

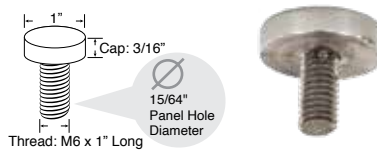

Part #	Diameter
STDE-32CAP-BSS	1"
STDE-32CAP-PSS	1"

Finishes:
(BSS) Brushed Stainless
(PSS) Polished Stainless

Eco Solid Stainless Wall Mount



MATERIAL = 202 Stainless Steel
FINISH = Brushed Stainless (BSS)

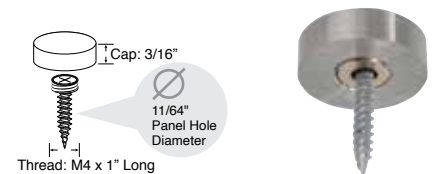

Finish:
(BSS)
Brushed Stainless
CAP & SCREW SET
UNDER CAP VIEW

Part #	Diameter
STD-C2P20-BSS	5/8"
STD-C2P24-BSS	3/4"
STD-C2P32-BSS	1"



Please visit page C-26 for our wall anchor selections

Premium Steel Wall Mount Signage Caps



MATERIAL = Solid Carbon Steel
FINISHES = Polished Chrome (*PC), Matte Chrome (*MC), Black Nickel (*BN), Bright Brass(*BB), Brushed Stainless (*BSS)

Part #	Diameter
STD-24CAP.*	3/4"
STD-40CAP.*	1-1/4"

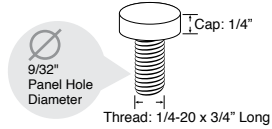

Premium Aluminum Wall Mount Signage Caps



MATERIAL = Aluminum
FINISHES = Polished Chrome (PC), Polished Stainless (PS)

Part #	Diameter
STDA-24CAP-PC	3/4"
STDA-24CAP-PS	3/4"
STDA-40CAP-PC	1-1/4"
STDA-40CAP-PS	1-1/4"

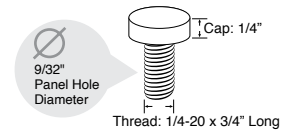

Insert Nuts



No Flange
I-NUT250

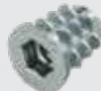

With Flange
I-NUT250F

Thread: 1/4-20

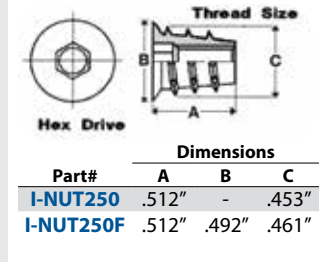

Button It



MATERIAL = Chrome Plated Solid Brass
FINISHES = Polished Chrome (PC), Matte Chrome (MC)

- Used to make "Sandwich" style signs
- Tightens with 2mm Hex Key included (**One per order**)

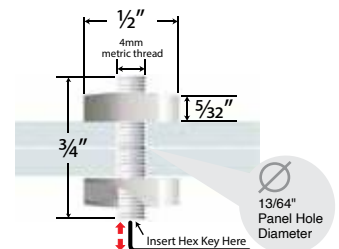

Part #	Panel Thickness	Diameter
STD-13CAPSET-PC	Up to 1/2"	9/16"
STD-13CAPSET-MC	Up to 1/2"	9/16"



Need Extra Hex Keys?

2 mm Hex Key
STD-ALANKEY-2



Please visit page C-26 for our wall anchor selections

LED

Perfect for lobbies & reception areas

12V

MATERIAL = Aluminum

- The standoff wire is 38" long
- Up to 10 pieces can be connected to one power supply
- #6 screws & drywall anchors included

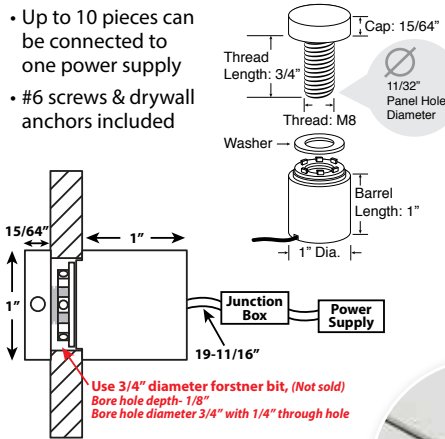

Maximum Recommended Spacing:
20" x 20" for 4 Standoffs

Finishes:

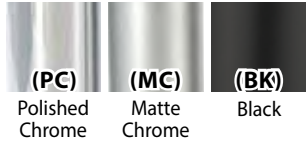

Lighting Specifications

Color Temperature	CW: 6000K-6500K
Beam Spread	120°
Lumens	CW: 30-40
Color Rendering Index	CW: 70
Rated Average Life	CW: 10,000 hrs.
Chip Size	SMD2908



Please visit page C-26 for our wall anchor selections

Part #	Color Temp	Finish	Panel Thickness (when graphic is routed)	Barrel Length	Thread Length	Diameter	# of LED	Total Wattage
STD-LED-2525-PC	Cool White	Polished Chrome	Up to 1/2"	1"	3/4"	1"	6	.4W
STD-LED-2525-MC	Cool White	Matte Chrome	Up to 1/2"	1"	3/4"	1"	6	.4W
STD-LED-2525-BK	Cool White	Black	Up to 1/2"	1"	3/4"	1"	6	.4W
STD-LED-2525-M-*	Red (*RD) Blue (*BL) Green (*GR)	Matte Chrome	Up to 1/2"	1"	3/4"	1"	6	.4W
STD-LED-2525-B-*	Red (*RD) Blue (*BL) Green (*GR)	Black	Up to 1/2"	1"	3/4"	1"	6	.4W

Power Supplies (Required)

LED-STD-TR-1A



2.91"L x 1.61"W x 1.14"H
1A / 12V / 12W
Input Cord: 5'
Color: Black

Junction Box (Required)

Function: Is to join multiple fixtures to one power supply.



LED-STD-JB10

2"L x 1-1/4"W x 1/2"D
Number of Outputs: 10
Input Cord: 19-11/16"
Color: White

Plug & Play
No Soldering

Optional Rechargeable Battery Available

See page R-136



How Long Will My Battery Last?

Battery Longevity:
(AMPS x VOLTS) = HRS
WATTS



Eco Invisible Standoffs



MATERIAL = Polycarbonate
FINISH = Clear

- No screws visible on the letter or sign front
- For letters & signs weighing up to .75 lbs.
- Available with or without adhesive
- #8 flat head screw & drywall anchor included

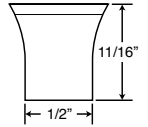
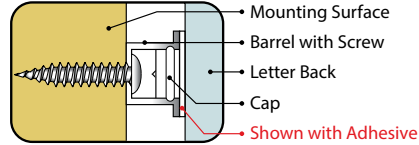
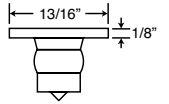

Part #	Description	Barrel Length	Diameter
STDI-6875	Invisible Standoff	11/16"	9/16"
STDI-6875-A	Invisible Standoff with Adhesive <i>For indoor use only</i>	11/16"	9/16"



Casper Invisible Standoffs



MATERIAL = Polycarbonate & Brass
FINISH = Chrome

- Must be purchased in increments of 4
- No screws visible on the sign front
- Removable
- Tamper proof

Kit Includes:

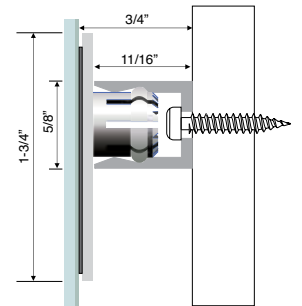
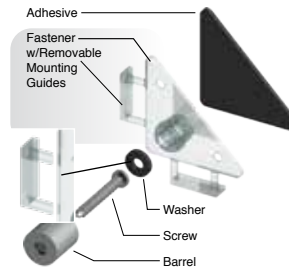

Part #	Barrel Length	Diameter
STDI-CASPER	11/16"	9/16"



Crystal Round Standoffs



MATERIAL = Clear Polycarbonate
FINISH = Clear

- Lightweight construction
- Tamper proof
- Cap snaps into body of standoff
- Metal spring clamp locks standoff in place

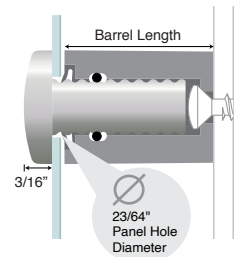

Part #	Panel Thickness	Barrel Length	Diameter
STD-P2026-CL	Up to 1/2"	13/16"	5/8"

Please visit page C-26 for our wall anchor selections

Invisi Hang Standoffs



MATERIAL = ABS

- Installs quickly and easily
- Load capacity 8 lbs. (4kg) per kit
- All mounting hardware & installation instructions included

Part #
STDI-INVHNG

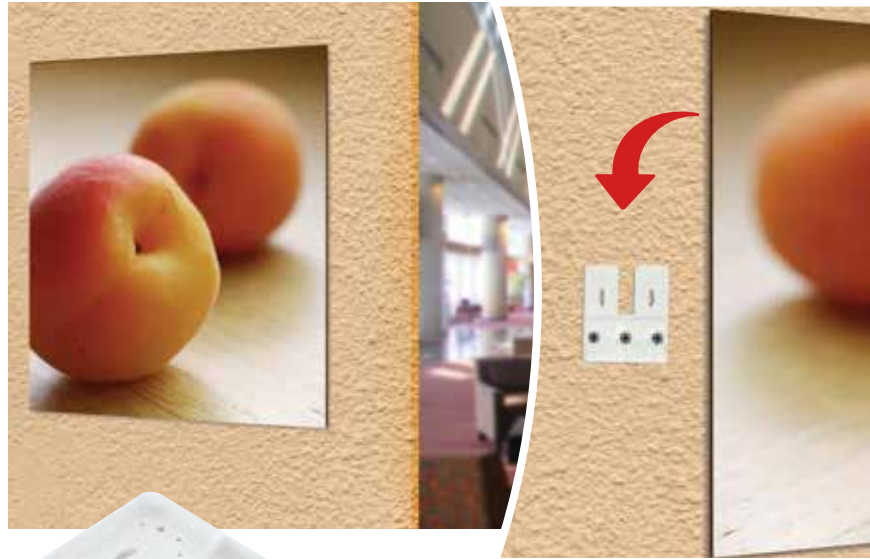
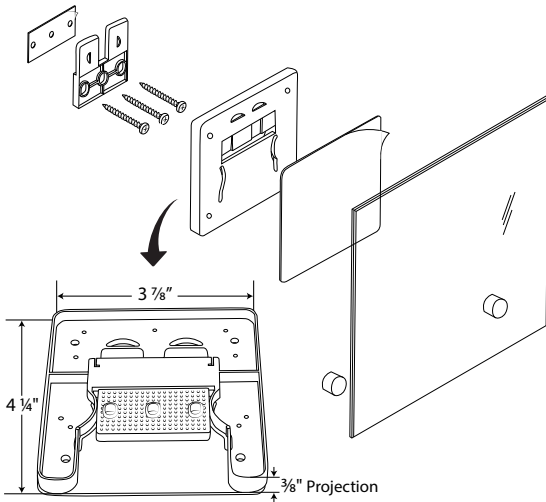

Kit Includes:

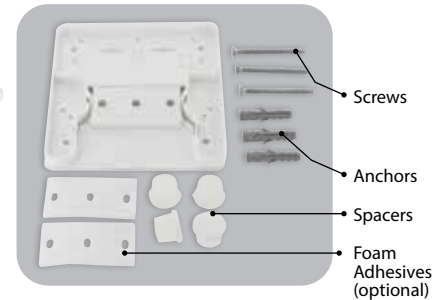

Wall Sign Kits

- Complete sign kit includes:
 - 2 pieces of 1/8" thick pre-drilled acrylic with polished green edges
 - 4 standoffs (3/4" diameter x 3/4") in brushed stainless finish
 - 4 mounting screws
- Premium Steel (-P), Eco Lite (-E) and Tamper Proof (-T) standoff kits available
- Available in a variety of sizes for uses ranging from directory signs to name plates



Kit shown with 6" x 6" sign size

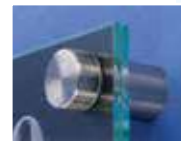
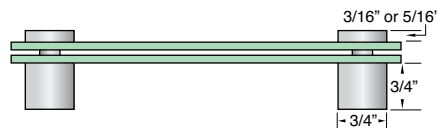
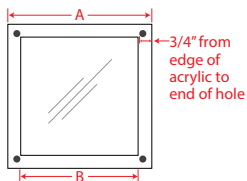

If desired, graphic can be brought to edge of acrylic



Part #	Overall Size	Reveal Size	Location of Standoffs	Premium Steel *(-P)	Eco Lite *(-E)	Tamper Proof *(-T)
STD-SIGN-63 -*	6" W x 3" H	4" W x 3" H	2 holes centered on short side			
STD-SIGN-66 -*	6" W x 6" H	4" W x 4" H	4 holes in the corners			
STD-SIGN-82 -*	8" W x 2" H	6" W x 2" H	2 holes centered on short side			
STD-SIGN-88 -*	8" W x 8" H	6 1/2" W x 6 1/2" H	4 holes in the corners			
STD-SIGN-811 -*	8 1/2" W x 11" H	6 1/2" W x 9" H	4 holes in the corners			

Need a fastener & an anchoring solution? See page G-32 for Screws & G-33 for Toggler Anchors

Anchoring Solutions for Standoffs

TOGGLER[®] BRAND SnapSku[®] Self Drilling Drywall Anchor

Securely hang alarms, mirrors, bathroom accessories, picture frames, drapery, lighting fixtures, smoke detectors, thermostats, electric boxes, etc.

- Material: Glass Filled Nylon
- Positive "stop" prevents overturning
- Can be used with a screw gun or hand drill
- Activates & locks with an audible "pop" indicating correct installation

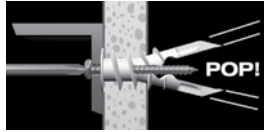
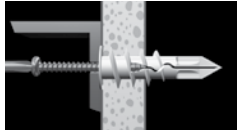

Part #	Description	Grip	Screw ^	Screws	Box
TA-0012	SP™ drywall anchors	3/8"-5/8"	#6-#10	50	50

^ # 8 Screw Preferred
#8 x 1 1/2" COMBO HEAD SCREWS INCLUDED IN TA-0012 BOXES
EACH ITEM IS SOLD IN FULL BOXES ONLY - NO BROKEN BOXES

TOGGLER[®] BRAND ALLIGATOR[®] Solid Wall Concrete Anchors

- Material: Self-lubricating polypropylene
- Corrosion proof when used with stainless steel screws
- Can be used with a screw gun
- Fins prevent spinning and countersink in the hole

Part #	Description	Screw	Drill	Box
TA-3103	AF™ 3/16" dia. flanged anchors	#4-#10	3/16"	200
TA-3101	AF6™ 1/4" dia. flanged anchors	#6-#14	1/4"	100
TA-3102	AF8™ 5/16" dia. flanged anchors	#6-5/16	5/16"	100
TA-3106	AF5™ 3/16" dia. flush mount anchors	#4-#10	3/16"	200
TA-3104	AF6™ 1/4" dia. flush mount anchors	#6-#14	1/4"	100
TA-3105	AF8™ 5/16" dia. flush mount anchors	#6-5/16	5/16"	100

For ultimate tensile holding values, see the technical bulletins on our Website at www.togglor.com
EACH ITEM IS SOLD IN FULL BOXES ONLY - NO BROKEN BOXES

Economy Flush Mount Drywall Anchor

- Material: Polypropylene
- Used for through the fixture mounting
- 1/4" Diameter



Part #	Overall Length	Screw	Drill
STD-ANCHOR	1-5/8"	#8	1/4"
STD-ANCHOR-6	1-3/16"	#6	1/4"

SOLD IN BOXES OF 100 - NO BROKEN BOXES

Economy Hollow Wall Anchor

- Material: Polypropylene
- Color: White
- Grip: 3/8"-7/16"
- Screw: #9-#13
- Drill: 5/16"
- Box: 100



Part #
HW-ANCHOR

Anchoring Solutions for Signage Caps

Insert Nuts

- Material: Zinc plated steel
- Thread: 1/4-20



No Flange
I-NUT250



With Flange
I-NUT250F

Part#	Dimensions		
	A	B	C
I-NUT250	.512"	-	.453"
I-NUT250F	.512"	.492"	.461"

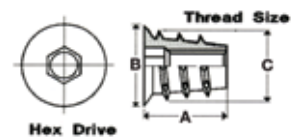

TOGGLER[®] BRAND SNAPTOGGLE[®] Toggle Bolt

Superior holding for heavy-duty anchoring in hollow walls and ceilings. Use in drywall, concrete block, plaster, tile over drywall, or tile over greenboard.



- Material: Zinc plated carbon steel & high impact polystyrene
- Carry twice the load in a smaller hole than standard wing toggles
- No spinning when used with a screw gun



Minimum clearance behind wall: 1 7/8" (48mm)

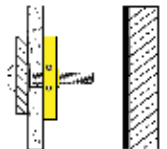

THREADED BOLTS ARE NOT INCLUDED—
EACH ITEM IS SOLD IN FULL BOXES ONLY—NO BROKEN BOXES

For ultimate tensile holding values, see the technical bulletins on our Website at www.togglor.com

Part #	Description	Thread	Drill	Grip	Box
TA-1014	BB™ snaptoggle toggle bolt	1/4"-20	1/2"	3/8"-3-5/8"	100

See Page G-33 for more Anchors

- An easy & affordable way to emphasize brands & your marketing message.
- Channels can easily be cut-to-size to accommodate a variety of banner widths.
- All channels can be used as a top & bottom rail.



142F-

- Material: Styrolux
- Flared legs for easy graphic insertion

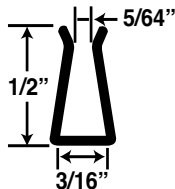

Part #	Color	Length
142F-CL	Clear	12'
142F-BK	Black	12'
142F-WH	White	12'



670-A-

- Material: Styrolux
- Classic universal clip design

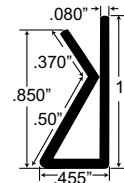

Part #	Color	Length
670-A-BK	Black	8'
670-A-WH	White	8'



HS-447- "Super Clamp"

- Material: PVC
- Each 4' length piece comes with 6 hanging hardware (BH-788-H) to hang banner onto the wall or from the ceiling (see ceiling clips on page C-76)

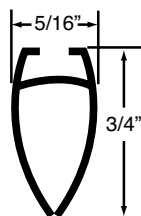

Part #	Color	Length
HS-447-CL	Clear	4'
HS-447-BK	Black	4'
HS-447-WH	White	4'



130- "Banner Clamp"

- Material: Clear PVC or Black & White Styrene

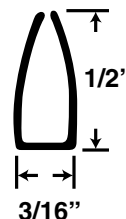

Part #	Color	*Length
130-CL-*	Clear	(*8) = 8 ft.
130-BK-*	Black	(*10) = 10 ft.
130-WH-*	White	



131- "Clamp It"

- Material: Clear PVC or Black & White Styrene

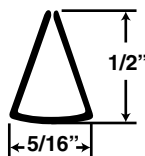

Part #	Color	*Length
131-CL-*	Clear	(*8) = 8 ft.
131-BK-*	Black	(*10) = 10 ft.
131-WH-*	White	



2326- "Banner Channel"

- Material: Black ABS with high gloss film on the front of the profile

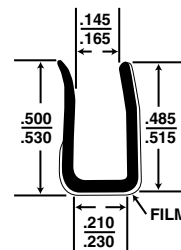

Part #	Color	Length
2326-BK	Black	12'



1059- "Banner Channel"

- Material: Rigid PVC

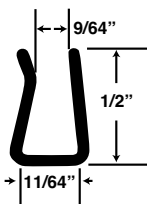

Part #	Color	Length
1059-CL	Clear	12'



HS-2010- "The Great Gripper"

- Material: PVC
- Each 8' length piece comes with 4 hanging hardware (BH-788-H) to hang banner onto the wall or from the ceiling (see ceiling clips on page C-77)

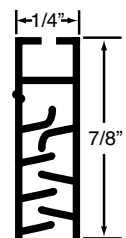

Part #	Color	Length
HS-2010-CL	Clear	8'

Sign / Banner Holders

- An easy & affordable way to emphasize brands & your marketing message.
- Channels can easily be cut-to-size to accommodate a variety of banner widths.
- All channels can be used as a top & bottom rail.

PFLF-1200-



Holds up to 1/8" thick material

- Material: Dual Durometer PVC
- With or without adhesive

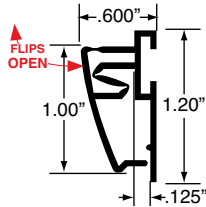

Part #	Color	Length
PFLF-1200-BK	Black	12'
PFLF-1200-SL	Silver	12'
PFLF-1200-WH	White	12'
with Adhesive		
PFLF-1200A-BK	Black	12'
PFLF-1200A-SL	Silver	12'

PFLF-1040-



Holds up to 1/16" thick material

- Material: Dual Durometer PVC
- With or without adhesive

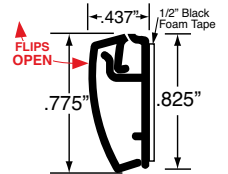

Part #	Color	Length
PFLF-1040-BK	Black	12'
PFLF-1040-SL	Silver	12'
PFLF-1040-WH	White	12'
with Adhesive		
PFLF-1040A-BK	Black	12'
PFLF-1040A-SL	Silver	12'
PFLF-1040A-WH	White	12'

BH-788- "Banner Holder" w/Snap Action



Holds up to 1/8" thick material

- Material: Styrene
- Contoured shape allows for 2 sided graphics
- Easy mount channel for hanging hardware (BH-788-H), hang banner onto the wall or from the ceiling.

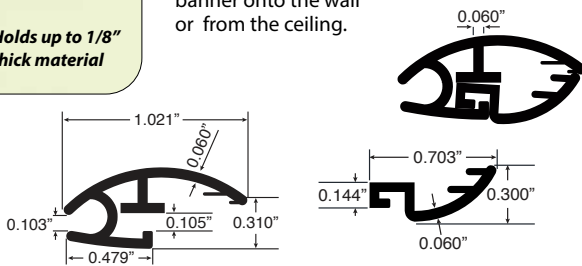

Part #	Color	Length
BH-788-BK	Black	8'
BH-788-WH	White	8'

2799- "Mini Snap"



Holds up to 1/16" thick material

- Material: Rigid PVC

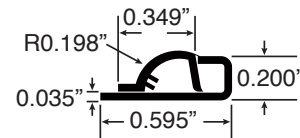

Part #	Color	Length
2799-BK	Black	8'
2799-WH	White	8'

BH-788-H- "Universal Hanger"



Fits into channels up to 1/4" wide

- Material: Clear Polyethylene
- Easily slides into the BH-788- "Banner Holder", HS-2010-CL "The Great Gripper" and HS-447- "Mini Snap".

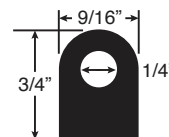

Part #	Color
BH-788-H	Clear

“KLEMMFIX” SIGN HOLDERS

*A quick & easy way to install and replace signs.
Simply snap open, insert material & close.
No notching or stapling required.*

Available In Black, White & Clear PVC · 8 Ft. Lengths



KLEMMFIX 18

SPECIFICATIONS:

- Suitable for paper thickness up to .04 inch.
- Stocked with & without adhesive backing.
- Hooks are available for hanging applications.

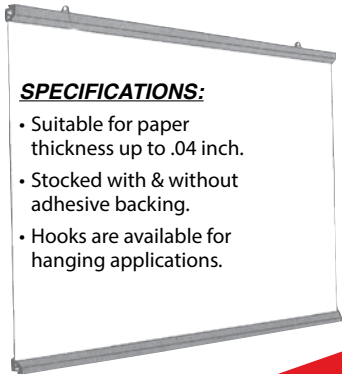

Part #	Color
Without Adhesive Backing	
3000-18BK	Black
3000-18WH	White
3000-18CL	Clear

With Adhesive Backing	
3000-18WH-T	White
3000-18CL-T	Clear

KLEMMFIX 28

SPECIFICATIONS:

- Suitable for paper thickness up to .08 inch.
- Hooks are available for hanging applications.



Part #	Color
3000-28BK	Black
3000-28WH	White
3000-28CL	Clear

KLEMMFIX 36

SPECIFICATIONS:

- Suitable for paper thickness up to .08 inch.

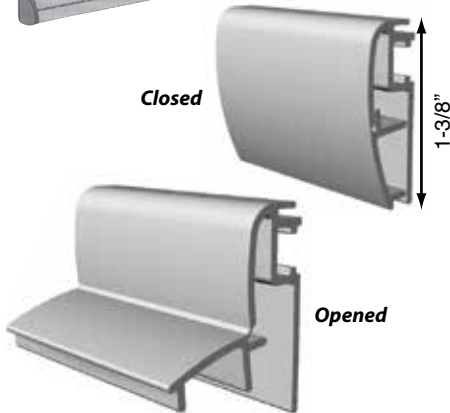

Part #	Color
3002-36BK	Black

END CAPS For Klemmfix 36

MATERIAL: Polypropylene



Part #	Color
3003-END-BK	Black
3003-END-WH	White

HANGING CLIPS
For Klemmfix 18, 28 & 36
MATERIAL: Polypropylene



Part #	Color
3001-PH-BK	Black
3001-PH-WH	White
3001-PH-CL	Clear



THE "SNAP-EASE" ALUMINUM BANNER HANGING SYSTEM

CLEAR ANODIZED ALUMINUM
24", 36", 48" & 96" LENGTHS

NOTE: ALL LENGTHS ARE NOMINAL

**ADDS
STYLE & VALUE**

- Clear anodized aluminum finish with 4 black plastic end caps for a "finished" look.
- The spring clips inside the rail will "snap" close to securely hold your banner in place.
- Ideal for paper, fabric and vinyl banners up to .08" thick.
- Recommend to be used at the bottom of your banner for added stability.
- Includes removable hanging clips. The banner hanging system can be attached to the wall or hung from the ceiling using our ceiling hooks shown on [page C-77](#).

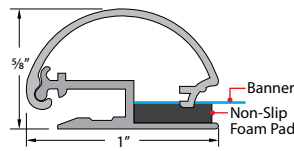
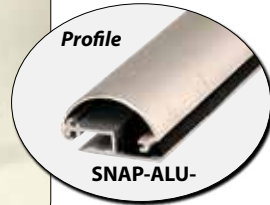

Part #	Length
SNAP-24	24"
SNAP-36	36"
SNAP-48	48"

Components To Complete Your Customization

Hanging Clips



SNAP-HC

End Caps



SNAP-EC

Spring Clips



SNAP-SC

4" Joiner Bar



HGR-JOIN

Material: Aluminum
Finish: Mill



Use to
join rails

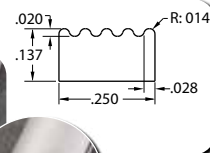

**Cut to Size and
Simply Assemble**

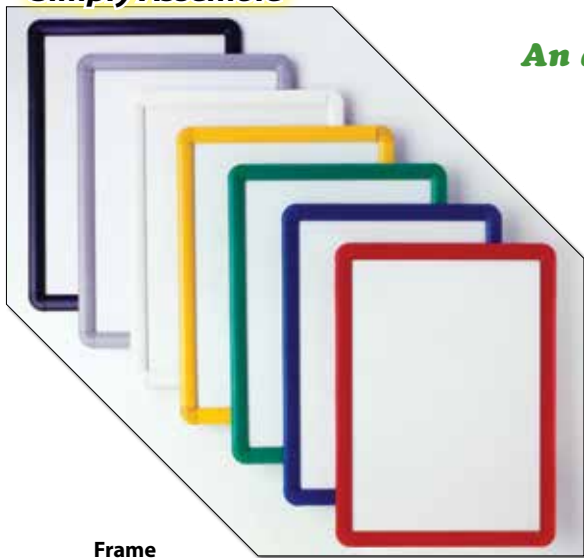

QUICK GRIP FRAMING SYSTEM

PVC FRAME PROFILES • LENGTHS: 8 FT.

**An affordable way to make “Flip Open” frames
in a variety of sizes and colors.**

2 ASSEMBLY METHODS TO CHOOSE FROM!

**Rounded Corner
saves time!**

Easy to install when
frame assembled
with corners!



**Mitred Corner
saves money!**

When profile mitred,
then no need to
spend extra money
on corners!



★ Easy to use! Simply position your hinge to the backboard of your choice & staple down. Then, slide your corner into the end of your cut frame profile & slide the sign on your hinges. If profiles are mitred, then slide on the hinge.

Frame
Opened



**DISCONTINUED
PLEASE CALL ONE OF OUR SALES ASSOCIATES FOR OTHER OPTIONS**

“STOCK COLORS”

Available in black, white, red, and gray PVC frame profiles. Other colors available on a per order basis: Blue, green or yellow. Can color match any color. Minimums apply, please inquire.



BLACK

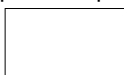

WHITE



RED



GRAY

“ROUNDED CORNERS”

Available in UV stabilized plastic PVC.

- Slides directly into frame extrusion.
- No tools or cutting required.



SHOWN IN
BLACK

“THE HINGE”

★ Unique & patented “Hinge” aids in the ease of use, because it does not require connecting corners & spring clips like typical front loading frames.

- Available in black polypropylene only.
- Must use two hinges for each side.
- It is recommended to use one hinge every 2 ft.



PROFILES

Rounded Part #	Flat Part #	Color
35-5000-BK	28-5000-BK	Black
35-5000-GRY	28-5000-GRY	Gray
35-5000-RED	N/A	Red
35-5000-WH	28-5000-WH	White

CORNERS

Rounded Part #	Flat Part #	Color
35-5100-BK	28-5100-BK	Black
35-5100-GRY	28-5100-GRY	Gray
35-5100-RED	N/A	Red
35-5100-WH	28-5100-WH	White

“THE HINGE”

Part #
HINGE

Front Loading Plastic Frame Profiles

These plastic profiles can be easily cut & mitered to a variety of frame sizes. The flip open & snap close design will allow you to change graphics without disassembling the whole unit!



**8 Ft. Lengths W/Adhesive
High Gloss Black (BK)**

• Material: PVC

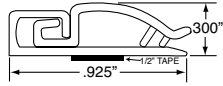

Part #	Description
DFL-8-BK	High gloss black- 2 piece frame



**12 Ft. Lengths
White (*WH), Black (*BK), Silver (*SI)**

• Material: Dual Durometer PVC

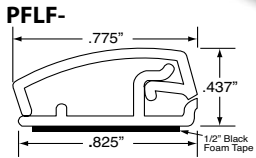

Part #	Description
PFLF-1040-*	w/o Adhesive
PFLF-1040A-*	w/ Adhesive

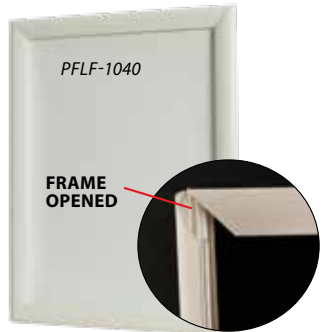

**12 Ft. Lengths
White (*WH), Black (*BK), Silver (*SI)**

• Material: Dual Durometer PVC
• Metal corner to hold miter cut

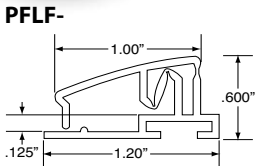

Part #	Description
PFLF-1200-*	w/o Adhesive
PFLF-1200A-*	w/ Adhesive

METAL CORNER	
Part #	Description
PFLF-1200-CORN	



Plastic Frame Mouldings

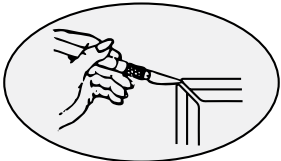

EZ Frame #981 comes in two pieces that are channeled with the back piece (981b) mounted flush to the wall with double face tape for ease of installation.

There is no need to take down frames from wall to change a new picture.

EZ FRAME

**12 Ft. Lengths
White & Black**
Up To 1/4" Thick Material

Part#
981EZ-WH
981EZ-BK

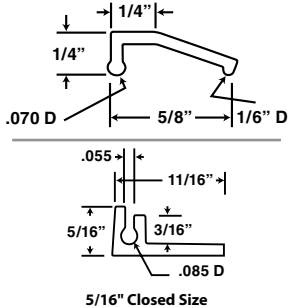

PLEASE NOTE: Our adhesive is strong but is only designed to assist in assembly. Remember always to staple or screw to substrate.

"SNAP-EASE" FRONT LOADING FRAME PROFILES

MAKE YOUR OWN FRAMES WITH OUR COMPONENTS!

- Stocked in 8 ft. lengths for  shipping
- Each profile includes base and cap



- Clear Anodized (AL)
- Black (BK)
- Brushed Nickel (BRN)
- Mill (M)

4 FINISHES

3 STYLES



CREATE CUSTOM FRAMES!

SHOWN ASSEMBLED

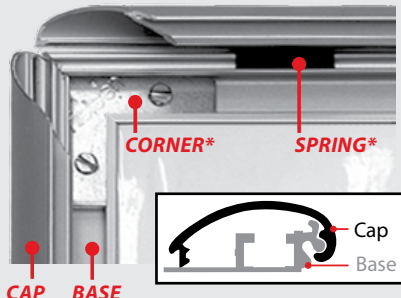

***CORNER:** Joins mitered profiles. 4 required to assemble frame.

***SPRING:** Allows frame to open and snap-close. Requires minimum 2 per 10" and 1 every additional 4-6".

Example: 22" x 28" frame = [4] [5] springs

*** Corners and Springs sold separately**

"SNAP-EASE" FRONT LOADING FRAME PROFILES

MAKE YOUR OWN FRAMES WITH OUR COMPONENTS!

Stocked in
8 ft. lengths

FLF-8-

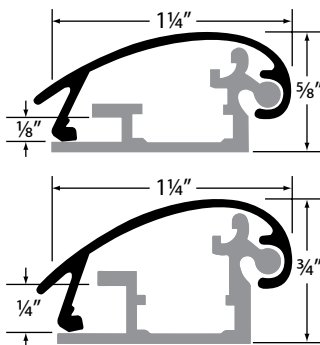
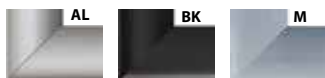

FOR 1/8" INSERT With Matching Base & Cap Finish

Part #	Base & Cap Finish
FLF-8-AL	Clear Anodized
FLF-8-BK	Black Matte
FLF-8-M	Mill

With Mill Base & Finished Cap

Part #	Cap Finish
FLF-8M-AL	Clear Anodized
FLF-8M-BK	Black Matte

FOR 1/4" INSERT With Mill Base & Finished Cap

Part #	Cap Finish
FLF-8QM-AL	Clear Anodized
FLF-8QM-BK	Black Matte
FLF-8Q-M	Mill

REQUIRED ACCESSORIES



FLF-CORNER
joins mitered profiles
(Requires 4 per frame)



FLF-SPRING
to open/close frame
(min. 2 per 10")

"SNAP-EASE" FRONT LOADING FRAME PROFILES

Stocked in
8 ft. lengths

FLF-19N-

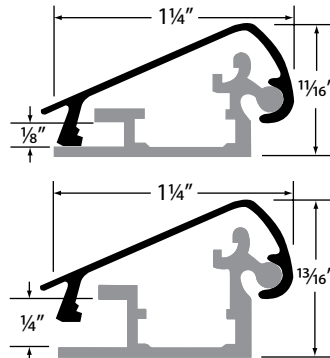
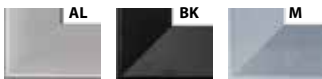

REQUIRED ACCESSORIES



FLF-19N-CORNER
joins mitered profiles
(Requires 4 per frame)



FLF-19N-SPRING
to open/close frame
(min. 2 per 10")

FLF-37S-

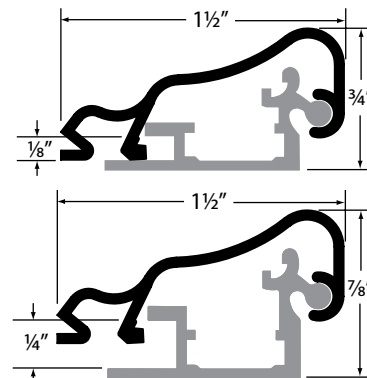
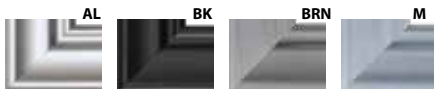

REQUIRED ACCESSORIES



FLF-37S-CORNER
joins mitered profiles
(Requires 4 per frame)



FLF-37S-SPRING
to open/close frame
(min. 2 per 10")

FOR 1/8" INSERT With Matching Base & Cap Finish

Part #	Base & Cap Finish
FLF-19N-AL	Clear Anodized
FLF-19N-BK	Black Matte
FLF-19N-M	Mill

With Mill Base & Finished Cap

Part #	Cap Finish
FLF-19NM-AL	Clear Anodized
FLF-19NM-BK	Black Matte

FOR 1/4" INSERT With Mill Base & Finished Cap

Part #	Cap Finish
FLF-19NQM-AL	Clear Anodized
FLF-19NQM-BK	Black Matte
FLF-19NQ-M	Mill

FOR 1/8" INSERT With Matching Base & Cap Finish

Part #	Base & Cap Finish
FLF-37S-AL	Clear Anodized
FLF-37S-BK	Black Matte
FLF-37S-BRN	Brushed Nickel
FLF-37S-M	Mill

With Mill Base & Finished Cap

Part #	Cap Finish
FLF-37SM-AL	Clear Anodized
FLF-37SM-BK	Black Matte
FLF-37SM-BRN	Brushed Nickel

FOR 1/4" INSERT With Mill Base & Finished Cap

Part #	Cap Finish
FLF-37SQM-AL	Clear Anodized
FLF-37SQM-BK	Black Matte
FLF-37SQM-BRN	Brushed Nickel

Crystal Light Box

For Counter & Wall Mount Displays

Material: Acrylic with Aluminum Post

- Super thin 3/8"
- Available in wall mount & counter top
- Power supply included
- Includes On / Off Switch

SLEEK THIN DESIGN

COUNTER TOP



WALL MOUNT



DISCONTINUED
 PLEASE CALL ONE OF OUR SALES ASSOCIATES FOR OTHER OPTIONS



BEVELED EDGE CREATES OUTER GLOW ILLUMINATION!

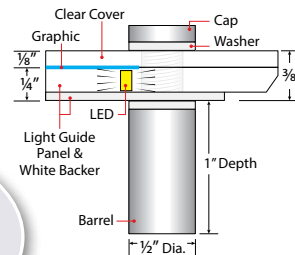

Lighting Specifications

Color Temperature	CW: 6100K
Lumens	CLB-LED-0811-W: 186 CLB-LED-1117-W: 93 CLB-LED-1620-W: 102 CLB-LED-2228-W: 121 CLB-LED-2436-W: 167 CLB-LED-0811-C: 186 CLB-LED-1117-C: 93
Color Rendering Index	CW: 70
Rated Average Life	50,000 hrs.
Constant	Voltage
Chip Size	SMD2835

Part #	Color Temp	Graphic Size	Reveal Dimensions (Nominal)	Overall Dimensions (Nominal)	Total Wattage
CLB-LED-0811-W	Cool White	8.5" x 11"	8" x 10-5/8"	10-13/16" x 13-5/16"	1.8
CLB-LED-1117-W	Cool White	11" x 17"	10-5/8" x 16-5/8"	13-3/4" x 19-3/4"	3.6
CLB-LED-1620-W	Cool White	16" x 20"	15-1/2" x 19-3/4"	18-1/4" x 23-11/16"	6
CLB-LED-2228-W	Cool White	22" x 28"	21-9/16" x 27-9/16"	24-3/4" x 30-3/4"	9
CLB-LED-2436-W	Cool White	24" x 36"	23-1/2" x 35-5/8"	27-1/8" x 39-1/8"	11
CLB-LED-0811-C	Cool White	8.5" x 11"	8" x 10-5/8"	10-13/16" x 13-5/16"	1.8
CLB-LED-1117-C	Cool White	11" x 17"	10-5/8" x 16-5/8"	13-3/4" x 19-3/4"	3.6

Available for either wall mount (-w) or counter top (-c) applications.

12V



Fully Assembled Front Loading Aluminum Frames

Material: Aluminum Frame with Acyclic Light Guide Panel

- Comes ready to use: Clear PVC cover, mounting hardware & power supply included
- Easy front load feature
- Can be used either landscape or portrait
- Low profile, should meet ADA requirements
- Plug & Play

FRONT VIEW

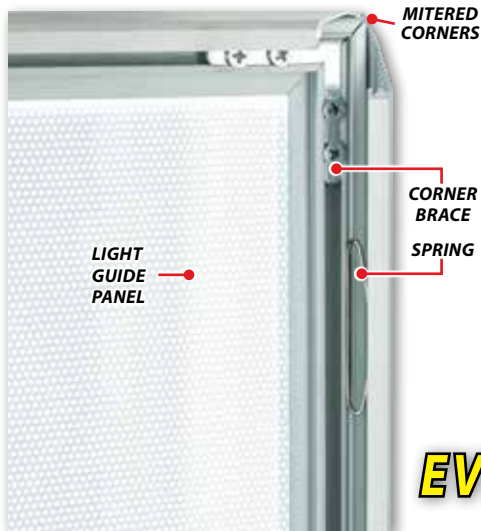

SHOWN ILLUMINATED

SUPER BRIGHT! EVEN ILLUMINATION!

BACK VIEW

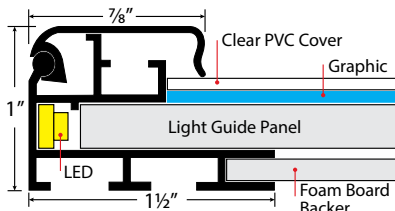
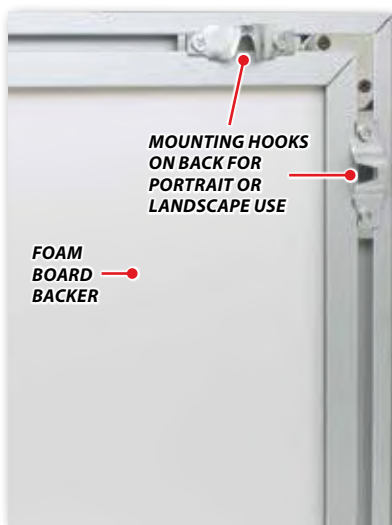

**BEVELED EDGE
PROFILE**



Lighting Specifications

Color Temperature	WW: 7500K-8500K
Lumens	FLF-LED-0811: 275
	FLF-LED-1117: 475
	FLF-LED-1620: 625
	FLF-LED-2228: 1000
FLF-LED-2436: 1250	
Color Rendering Index	CW: 75-80
Rated Average Life	50,000 hrs.
Chip Size	SMD2835



Part #	Color Temp	Finish	Graphic Size	Reveal Dimensions (Nominal)	Overall Dimensions (Nominal)	Total Wattage
FLF-LED-0811	Cool White	Anodized Aluminum	8.5" x 11"	8-1/8" x 10-11/16"	10-1/8" x 12-3/4"	3
FLF-LED-1117	Cool White	Anodized Aluminum	11" x 17"	10-5/8" x 14-3/8"	12-1/2" x 18-5/16"	4
FLF-LED-1620	Cool White	Anodized Aluminum	16" x 20"	15-19/32" x 19-5/8"	17-3/8" x 21-3/8"	6
FLF-LED-2228	Cool White	Anodized Aluminum	22" x 28"	21-1/2" x 27-1/2"	23-3/8" x 29-3/8"	10
FLF-LED-2436	Cool White	Anodized Aluminum	24" x 36"	23-5/8" x 35-1/2"	25-1/2" x 37-3/8"	13

Fully Assembled, Front Loading Aluminum Frames

ATTRACTIVE AND EASY-TO-USE!

Built-in spring loaded hinge enables you to change graphics in a snap without disassembling the frame.



Shown: FRM-1117-SIL

- Fully assembled frame comes with clear non-glare lens and back panel
- Strong aluminum construction
- Snap/Spring loaded
- Screw holes on the back for easy mounting - portrait or landscape
- Screws and drywall anchors are included
- Custom sizes and finishes available at a minimum. Please inquire for more details.

6 SIZES TO CHOOSE FROM...

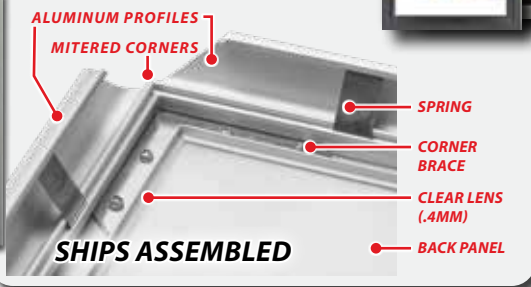

...AN ARRAY OF STYLES!

1" Easy-Frame With Clear Anodized, Black Powder Coat Or Woodgrain Finish

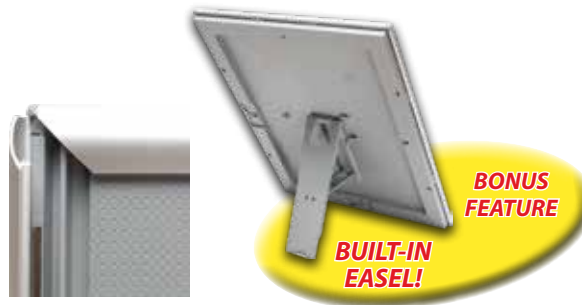
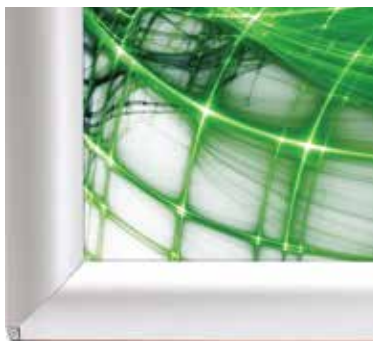

- Mounts Portrait or Landscape
- 2 Holes on 2 sides
- Screws & Anchors included

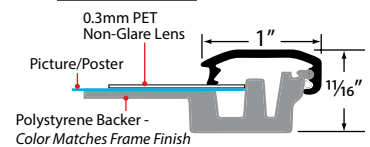

Part #	Graphic Size	Reveal Dimensions	Overall Dimensions	Finish
FRM-08511-SIL	8-1/2" x 11"	7-3/4" x 10-1/4"	9-3/4" x 12-1/4"	Clear Anodized
FRM-08511-WG	8-1/2" x 11"	7-3/4" x 10-1/4"	9-3/4" x 12-1/4"	Woodgrain

Custom sizes & finishes can be produced. Please Inquire.
Packed 5 per carton. Broken box fee (BB5) for less than full carton.

Fully Assembled, Front Loading Aluminum Frames

Built-in spring loaded hinge enables you to change graphics in a snap without disassembling the frame.

1" Frame With Clear Anodized Or Black Powder Coat Finish

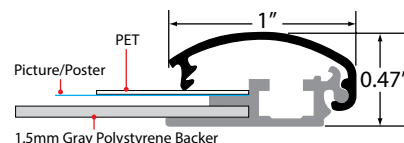
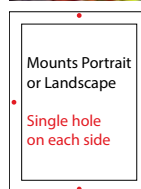

Part #	Graphic Size	Reveal Dimensions	Overall Dimensions	Finish
FRM-8511-SIL	8-1/2" x 11"	7-5/8" x 10-1/8"	9-11/16" x 12-3/16"	Clear Anodized
FRM-8511-BK	8-1/2" x 11"	7-5/8" x 10-1/8"	9-11/16" x 12-3/16"	Black Powder Coat
FRM-1117-SIL	11" x 17"	10-1/4" x 16-3/16"	12-1/4" x 18-3/16"	Clear Anodized
FRM-1117-BK	11" x 17"	10-1/4" x 16-3/16"	12-1/4" x 18-3/16"	Black Powder Coat
FRM-1620-SIL	16" x 20"	15-1/8" x 19-1/8"	17-3/16" x 21-3/16"	Clear Anodized
FRM-1620-BK	16" x 20"	15-1/8" x 19-1/8"	17-3/16" x 21-3/16"	Black Powder Coat
FRM-2228-SIL	22" x 28"	21-5/8" x 27-11/16"	24-1/8" x 30-1/8"	Clear Anodized
FRM-2436-SIL	24" x 36"	23-1/2" x 35-5/8"	26-1/8" x 38-1/8"	Clear Anodized

1-1/4" Frame With Black Powder Coat Finish

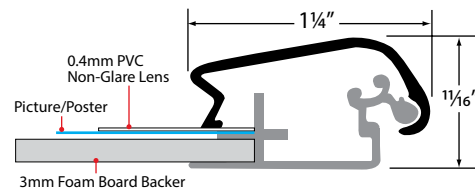
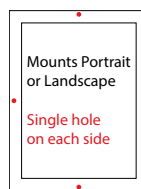

Part #	Graphic Size	Reveal Dimensions	Overall Dimensions
FRM-2228-BK	22" x 28"	21-5/8" x 27-11/16"	24-1/8" x 30-1/8"
FRM-2436-BK	24" x 36"	23-1/2" x 35-5/8"	26-1/8" x 38-1/8"

1-1/4" Frame With Clear Anodized Finish

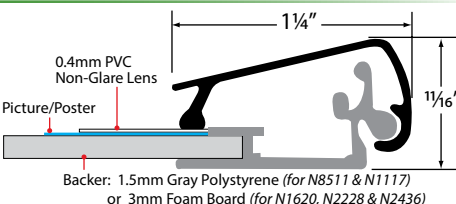
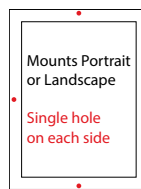
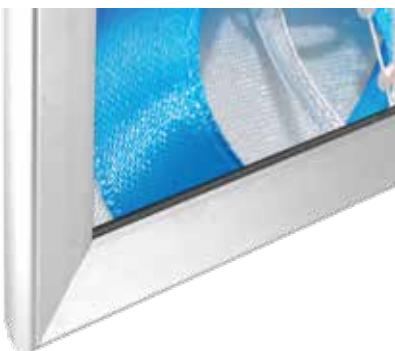

Part #	Graphic Size	Reveal Dimensions	Overall Dimensions
FRM-N8511-SIL	8-1/2" x 11"	8-1/16" x 10-5/8"	10-3/16" x 13-3/16"
FRM-N1117-SIL	11" x 17"	10-1/4" x 16-3/16"	12-3/16" x 18-1/8"
FRM-N1620-SIL	16" x 20"	15-1/2" x 19-1/2"	18" x 22-1/8"
FRM-N2228-SIL	22" x 28"	21-5/8" x 27-5/8"	24-1/8" x 30-1/8"

Custom sizes & finishes can be produced. Please Inquire.

Fully Assembled, Front Loading Aluminum Frames

Built-in spring loaded hinge enables you to change graphics in a snap without disassembling the frame.

1-1/4" Frame With High Quality Anodized Satin Silver Finish



while supplies last!



- Mounts Portrait or Landscape
- 2 Holes on 2 sides
- Screws & Anchors included

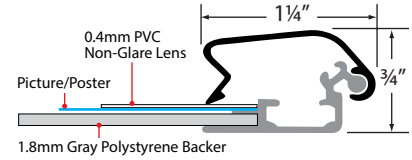

Part #	Graphic Size	Reveal Dimensions	Overall Dimensions
FRMD-B2436-SS	24" x 36"	23.29" x 35.29"	25.73" x 37.73"

1-7/16" Frame With High Quality Anodized Satin Silver Finish



while supplies last!

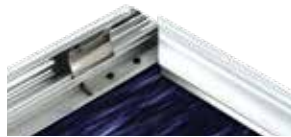

- Mounts Portrait or Landscape
- 2 Holes on 2 sides
- Screws & Anchors included



Part #	Graphic Size	Reveal Dimensions	Overall Dimensions
FRMD-D2228-SS	22" x 28"	21.05" x 27.05"	24.20" x 30.20"
FRMD-D2436-SS	24" x 36"	23.05" x 35.05"	26.20" x 38.20"

1-5/8" Frame With High Quality Anodized Satin Silver Finish



while supplies last!



- Mounts Portrait or Landscape
- 2 Holes on 2 sides
- Screws & Anchors included

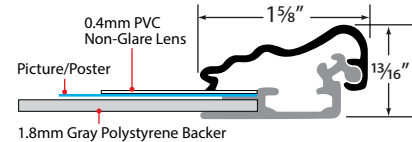

Part #	Graphic Size	Reveal Dimensions	Overall Dimensions
FRMD-D2228-SS	22" x 28"	21.05" x 27.05"	24.20" x 30.20"
FRMD-D2436-SS	24" x 36"	23.05" x 35.05"	26.20" x 38.20"

DISCONTINUED
PLEASE CALL ONE OF OUR SALES ASSOCIATES FOR OTHER OPTIONS

Custom sizes & finishes can be produced. Please Inquire.

Fully Assembled, Front Loading Aluminum Frames

Built-in spring loaded hinge enables you to change graphics in a snap without disassembling the frame.

1-1/4" Jumbo Frame With Clear Anodized Finish



- Mounts Portrait or Landscape
- 2 Holes on 2 sides
- Screws & Anchors included

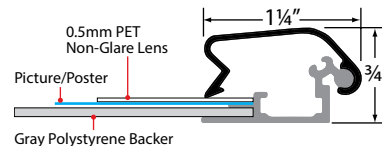

Part #	Graphic Size	Reveal Dimensions	Overall Dimensions
FRM-L3648-SIL	36" x 48"	35-1/4" x 47-1/4"	37-11/16" x 49-11/16"

1-3/4" Jumbo Frame With Clear Anodized Finish



- Mounts Portrait or Landscape
- 2 Holes on 2 sides
- Screws & Anchors included

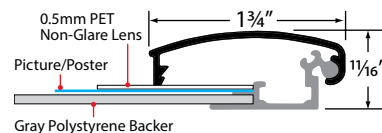

Part #	Graphic Size	Reveal Dimensions	Overall Dimensions
FRM-J3648-SIL	36" x 48"	34-1/4" x 46-1/4"	37-11/16" x 49-11/16"

1-1/4" Lockable Waterproof Frame With Clear Anodized Or Black Powder Coat Finish



- Mounts Portrait or Landscape
- 2 Holes on 2 sides
- Screws & Anchors included

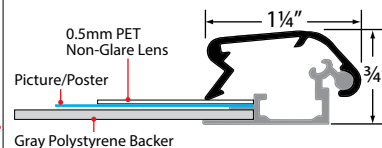

Part #	Graphic Size	Reveal Dimensions	Overall Dimensions	Finish
FRM-L2228-SIL	22" x 28"	21-11/16" x 27-11/16"	24-7/16" x 30-7/16"	Clear Anodized
FRM-L2228-BK	22" x 28"	21-11/16" x 27-11/16"	24-7/16" x 30-7/16"	Black Powder Coat
FRM-L2436-SIL	24" x 36"	23-11/16" x 35-11/16"	26-7/16" x 38-7/16"	Clear Anodized
FRM-L2436-BK	24" x 36"	23-11/16" x 35-11/16"	26-7/16" x 38-7/16"	Black Powder Coat

Custom sizes & finishes can be produced. Please Inquire.

Single Sided Slide In Frame

- Comes with mounting hardware (2 Screws & 2 Anchors)
- Anti-Glare 3mm PVC Lens
- White Backer Board
- Silver (Clear Anodized) Finish
- Can be used for either portrait or landscape orientation
- 4 Mounting Holes at 5/32" Diameter
- Frame Profile is 1" Wide
- Frame Thickness is 9/16" Thick

Part #	Graphic Size	Reveal Dimensions	Overall Dimensions
HGR-SL-845	8-1/2" x 11"	7-9/16" x 10-1/16"	9-13/16" x 12-5/16"
HGR-SL-1117	11" x 17"	10-1/16" x 16-1/16"	12-5/16" x 18-5/16"
HGR-SL-1824	18" x 24"	17-1/16" x 23-1/16"	19-5/16" x 25-5/16"
HGR-SL-2228	22" x 28"	21-1/16" x 27-1/16"	23-5/16" x 29-5/16"
HGR-SL-2436	24" x 36"	23-1/16" x 25-1/16"	25-5/16" x 27-5/16"

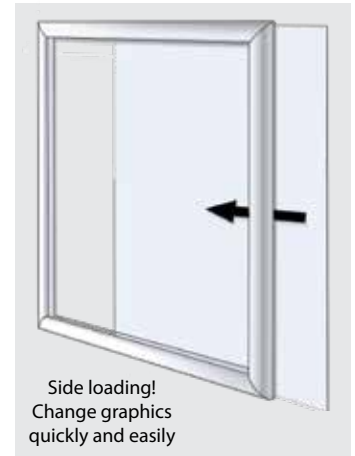

Z-Panel Hangers & Clips

For more details and other Z-Panel Hangers, see page A-36



"A FAST, EASY & COST EFFECTIVE METHOD OF HANGING CABINETS, WALL PANELS, PARTITIONS & SIGNAGE!"

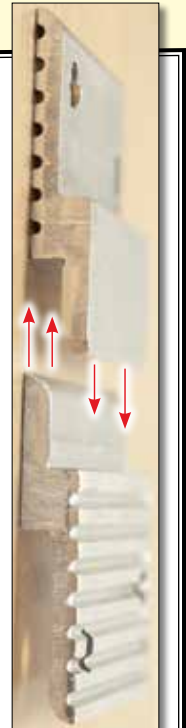
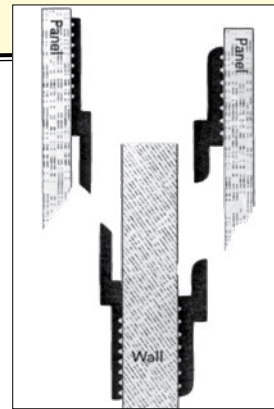
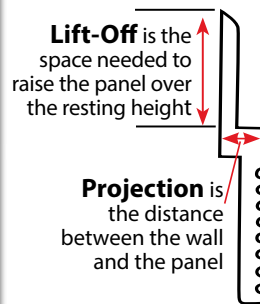

ALU-111	ALU-112	ALU-333
<p>Projection: 0.180" Lift Off: 0.750"</p>	<p>Projection: 0.240" Lift Off: 0.375"</p>	<p>Projection: 0.198" Lift Off: .673"</p>

Snap Graphic Grippers™ (Patented)

Material: Aluminum crossbar with co-extruded PVC gripper

Finishes: Satin Silver & Matte Black

- Quality gripper securely holds graphic after inserted into holder!
- Accepts single or double sided graphics
- Simply open plastic gripper, place graphic and snap close & load into aluminum casing
- Holds graphic up to .070 thick
- A variety of mounting options available for wall slatwall and ceiling (*See Below*)
- No assembly required, simply take out of the box and use!

Part #	Length	Finish
LRC-SGG-22-*	22"	Satin Silver *(SIL) Matte Black *(BK)
LRC-SGG-24-*	24"	
LRC-SGG-28-*	28"	
LRC-SGG-36-*	36"	
LRC-SGG-48-*	48"	
LRC-SGG-60-*	60"	
LRC-SGG-72-*	72"	

Unit Includes

- Top & Bottom Aluminum Casing
- Top & Bottom Plastic Grippers
- 2 Clear Plastic Hanging Clips
- 4 Black Plastic End Caps

Stainless Steel 3mm Cable with 2 Cable Sleeves

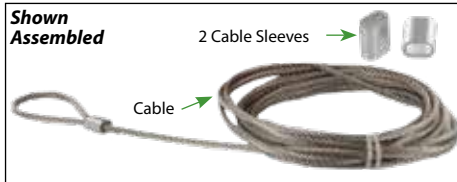

STAINLESS STEEL 3mm CABLE WITH 2 CABLE SLEEVES

Part #	Description
LRF-CLP6-1	1' Long Cable Assembly
LRF-CLP6-18	18" Long Cable Assembly
LRF-CLP6-2	2' Long Cable Assembly
LRF-CLP6-3	3' Long Cable Assembly
LRF-CLP6-4	4' Long Cable Assembly
LRF-CLP6-6	6' Long Cable Assembly

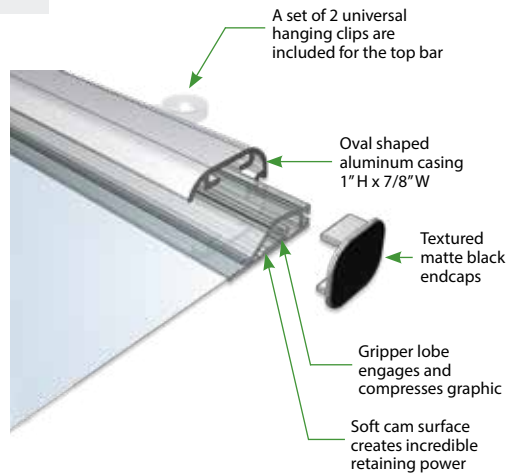

Accessories For Snap Graphic Grippers™



Wall Mount Kit

Set of 4 brackets for top & bottom cross bar
LRC-SGA-WMK



Slatwall Bracket Kit

Set of 2 for top bar & maximum length of 36"
LRC-SGA-SWB-SIL
Finish: Satin Silver



Perpendicular Wall Mount Bracket

Set of 2 for top bar & maximum length of 36"
LRC-SGA-WMB-
Finish: Satin Silver *(SIL) or Matte Black *(BK)



Horizontal Joiner

Set of 4 join top & crossbars horizontally
Allows casings to be joined in series
LRC-SGA-HJ

Hem Graphic Bar

Material: Lightweight aluminum bars
Finishes: Satin Silver

- Simply hem your graphics for top and bottom tubes
- Accommodates banner widths from 18" to 240"
- Ideal for vinyl banners
- Hem your graphics to fit a 7/8" or 1-1/4" diameter tube
- Hem bar is sold with eye bolt at the top crossbar and can be hung with cable and hooks
- For banner widths up to 72": No assembly required-ships in one section
- For banner widths greater than 72": Crossbar ships in 2 to 4 sections

- Unit Includes**
- Top & Bottom Crossbars
 - Eye Bolts For Each Top Crossbar
 - Black Plastic End Caps

Part #	Banner Width	Diameter	Sections
LRC-HGB-*18-SIL	18"	7/8"	1
LRC-HGB-*22-SIL	22"	7/8"	1
LRC-HGB-*24-SIL	24"	7/8"	1
LRC-HGB-*28-SIL	28"	7/8"	1
LRC-HGB-*36-SIL	36"	7/8"	1
LRC-HGB-*48-SIL	48"	7/8"	1
LRC-HGB-*60-SIL	60"	7/8"	1
LRC-HGB-*72-SIL	72"	7/8"	1
LRC-HGB-*96-SIL	96"	1-1/4"	2
LRC-HGB-*120-SIL	120"	1-1/4"	2
LRC-HGB-*144-SIL	144"	1-1/4"	2
LRC-HGB-*180-SIL	180"	1-1/4"	3
LRC-HGB-*240-SIL	240"	1-1/4"	4

*Eye bolts can be placed at ends



Stainless Steel 3mm Cable with 2 Cable Sleeves

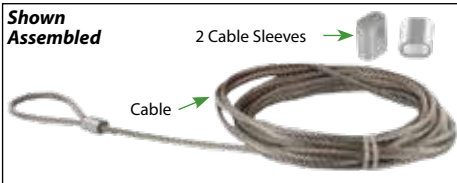

STAINLESS STEEL 3mm CABLE WITH 2 CABLE SLEEVES

Part #	Description
LRF-CLP6-1	1' Long Cable Assembly
LRF-CLP6-18	18" Long Cable Assembly
LRF-CLP6-2	2' Long Cable Assembly
LRF-CLP6-3	3' Long Cable Assembly
LRF-CLP6-4	4' Long Cable Assembly
LRF-CLP6-6	6' Long Cable Assembly

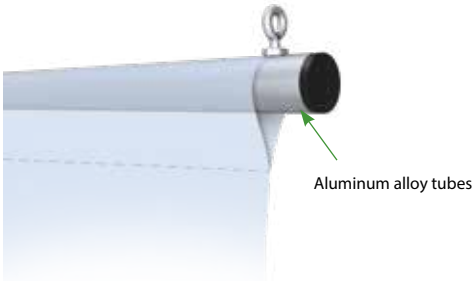

Aluminum alloy tubes

Multiple section units connect with solid aluminum turned bushing



Light Duty Channel Mount Hanging System

- **Material:** All Steel Construction - Cable & Toggle Hook
- Carbon Steel Hooks in Polished Chrome finish include **4 ft. of 2.5mm Steel Cable (Field cuttable)**
- Hooks have push button adjustment along the length of cable
- Aluminum mounting channel works with both roller and toggle style hooks



Need a fastener & an anchoring solution? See page G-32 for Screws, G-33 for Toggle Anchors

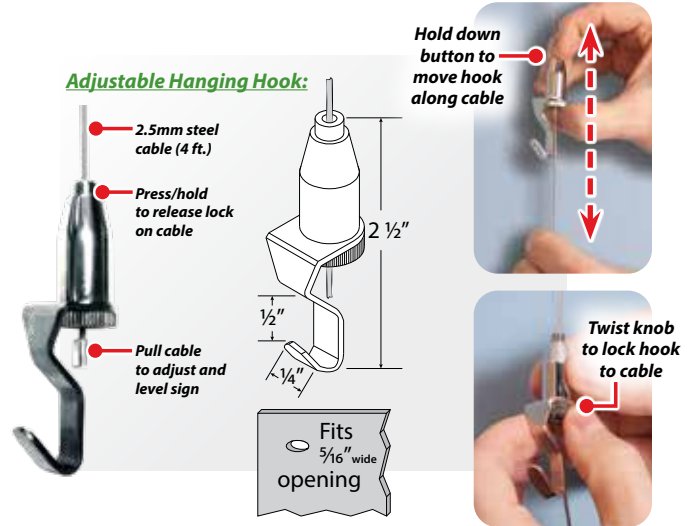

Clear Anodized Aluminum Mounting Channel



Roller Style Hook Kit

For side to side adjustment ceiling applications only

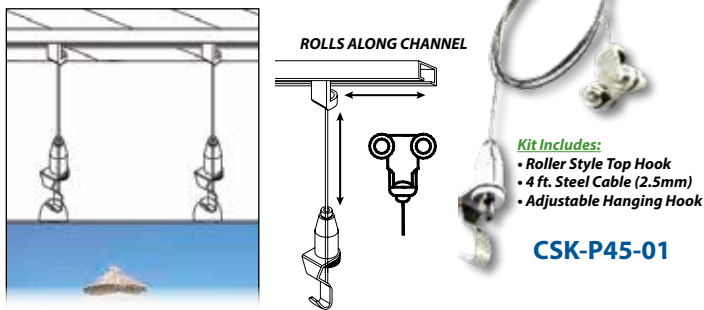

Toggle Style Hook Kit

For ceiling or wall mount applications

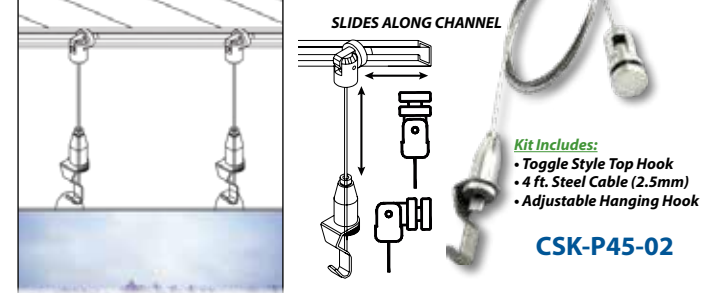

Loop End Hook Kit

For use with ceiling hooks
(Sold separately, see page C-76)

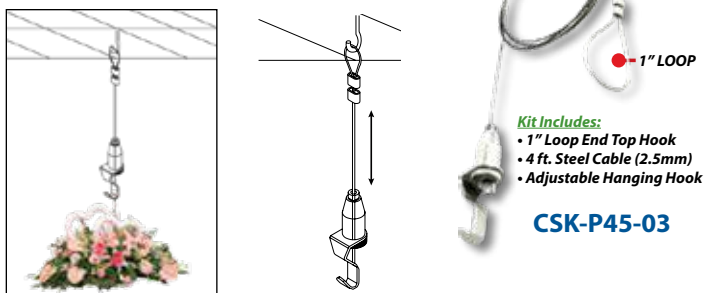

Locking Toggle Style Hook Kit

For ceiling or wall mount applications

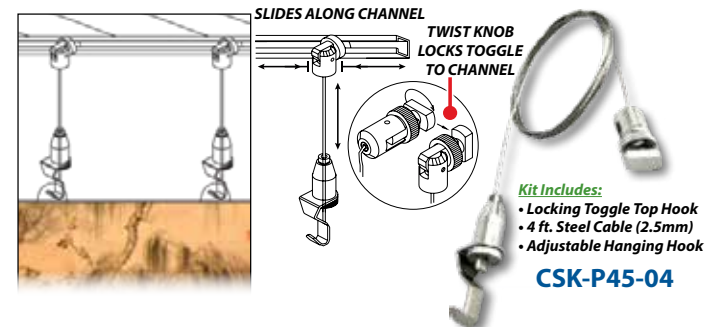

Locking Adjustable Cable Hook Kit w/Top Fitting

- **Material:**
Galvanized Steel Cable with Polished Chrome Steel Hook & Top Fitting
- **Wire Gauge:**
1.5mm

44 HOLDS
LBS. per
cable
assembly

Field Cuttable to Any Length

Kit Includes:

TOP FITTING
(Polished Chrome)

8 FT. / 15 FT.
STEEL CABLE
(1.5mm Thick)

**ADJUSTABLE
CABLE HOOK**
(Polished Chrome)

Mounting Screw Not Included

Toggle Option Available,
Please Inquire

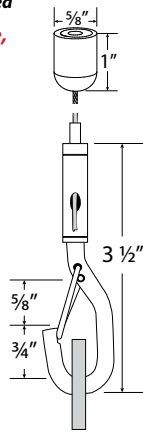
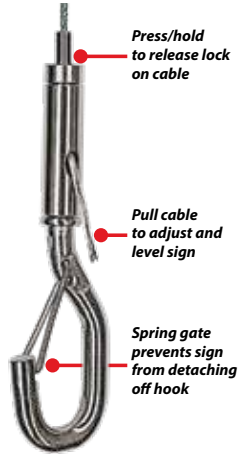

Fits
1/4" hole

Part #	Description
FWH-8-PC	8 ft. Cable
FWH-15-PC	15 ft. Cable

Locking Adjustable Cable Hook Kit w/2" Loop End

- **Material:**
Galvanized Steel Cable & Loop with Chrome Plated Steel Hook
- **Wire Gauge:**
1.5mm

44 HOLDS
LBS. per
cable
assembly

Field Cuttable to Any Length

Kit Includes:

**2" STEEL
LOOP**

**15 FT.
or 8 FT.**
STEEL CABLE
(1.5mm Thick)

**ADJUSTABLE
CABLE HOOK**
(Chrome Plated)

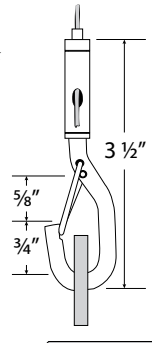
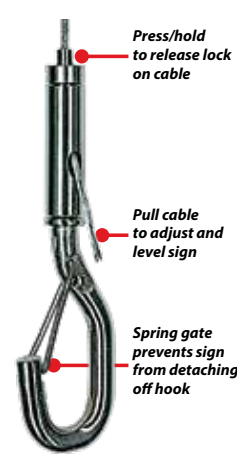

Fits
1/4" hole

Part #	Description
GSH-8	8 ft. Cable
GSH-15	15 ft. Cable

Secure Twist Ceiling Kit w/Standard Pear Clip

Kit Includes:

**SECURE METAL TWIST
CEILING LOOP CLIP**

- **Material:**
White Painted Steel
- 1" W x 1-1/2" Long
with 3/16" Diameter hole
- Fits most hooks



STANDARD PEAR CLIP

Material:
Zinc Plated Steel

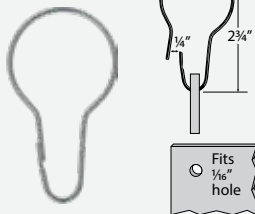

Part #
1215

Secure Twist Ceiling Kit w/Threaded Locking Pear Clip

Kit Includes:

**SECURE METAL TWIST
CEILING LOOP CLIP**

- **Material:**
White Painted Steel
- 1" W x 1-1/2" Long
with 3/16" Diameter hole
- Fits most hooks



THREADED LOCKING PEAR CLIP

Material:
Chrome Plated Steel

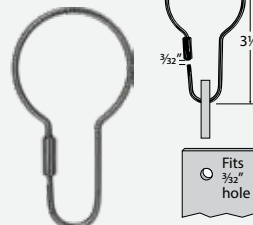

Part #
1216

Material: 1/8" Thick Non-Glare Clear Acrylic



- Can be used for both single sided and double sided applications
- Comes complete with all hanging hardware: (Pictured below)
 - 2 10 ft. length chains
 - 4 S-hooks (1-3/4" long)
 - 2 sets of ceiling clips (Right & Left)
- 3 sizes available

Complete System
Allows you to hang signage from ceiling, maximizing visibility!

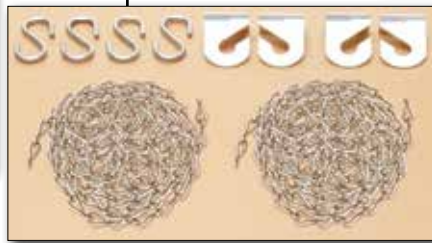
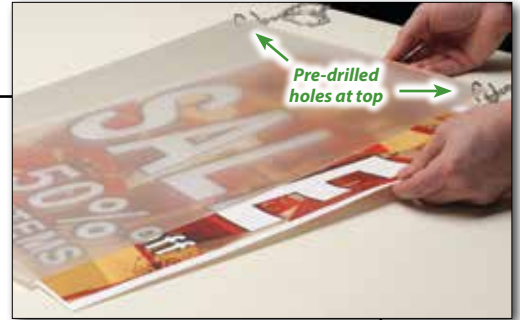

Part #	Size
CHS-2228-K	22" W x 28" H
CHS-2436-K	24" W x 36" H
CHS-3040-K	30" W x 40" H

Wall Sign Kits

- Complete sign kit includes:
 - 2 pieces of 1/8" thick pre-drilled acrylic with polished green edges
 - 4 standoffs (3/4" diameter x 3/4") in brushed stainless finish
 - 4 mounting screws
- Premium Steel (-P), Eco Lite (-E) and Tamper Proof (-T) standoff kits available
- Available in a variety of sizes for uses ranging from directory signs to name plates



Kit shown with 6" x 6" sign size

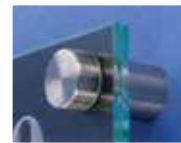
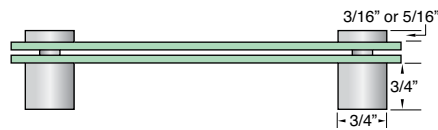
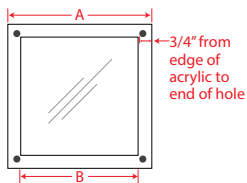

If desired, graphic can be brought to edge of acrylic



Part #	Overall Size	Reveal Size	Location of Standoffs	Premium Steel *(-P)	Eco Lite *(-E)	Tamper Proof *(-T)
STD-SIGN-63-*	6" W x 3" H	4" W x 3" H	2 holes centered on short side			
STD-SIGN-66-*	6" W x 6" H	4" W x 4" H	4 holes in the corners			
STD-SIGN-82-*	8" W x 2" H	6" W x 2" H	2 holes centered on short side			
STD-SIGN-88-*	8" W x 8" H	6 1/2" W x 6 1/2" H	4 holes in the corners			
STD-SIGN-811-*	8 1/2" W x 11" H	6 1/2" W x 9" H	4 holes in the corners			

Need a fastener & an anchoring solution? See page G-32 for Screws & G-33 for Toggler Anchors

STANDARD Duty Cable System

1.5mm Cable & Fittings

Supports up to 110 lbs. per cable



This low cost system includes **1.5mm** cables with **aluminum** fittings. This system is designed for small display areas up to **6'6"** high.



Contents

3 in 1 Cable Hardware Kits
For Both Standard 1.5mm
& Heavy Duty 3mm C-49

Standard 1.5mm Ceiling to Floor
Cable Signage C-50

Heavy Duty 3mm Ceiling to Floor
Cable Signage C-51

Standard 1.5mm Ceiling to Sign
Cable Signage C-52

Heavy Duty 3mm Ceiling to Sign
Cable Signage C-53

15 Series Cable Signage Kit C-54

30 Series Cable Signage Kit
Illuminating C-55

30 Series Cable Shelving C-56~57

Adjustable Cable Hook Sign Hanging
Hardware & Double Loop Cables .. C-58



HEAVY Duty Cable System

3mm Cable & Fittings

Supports up to 220 lbs per cable



This premium system includes **3mm** cables with **solid brass** fittings. This system is designed for large display areas up to **13'** high.

A wide range of shelving options are possible with this system as well as illuminated and non-illuminated signage options.



3 in 1 Cable Hardware Kits For Both Standard 1.5mm & Heavy Duty 3mm

One Fitting- Many Options

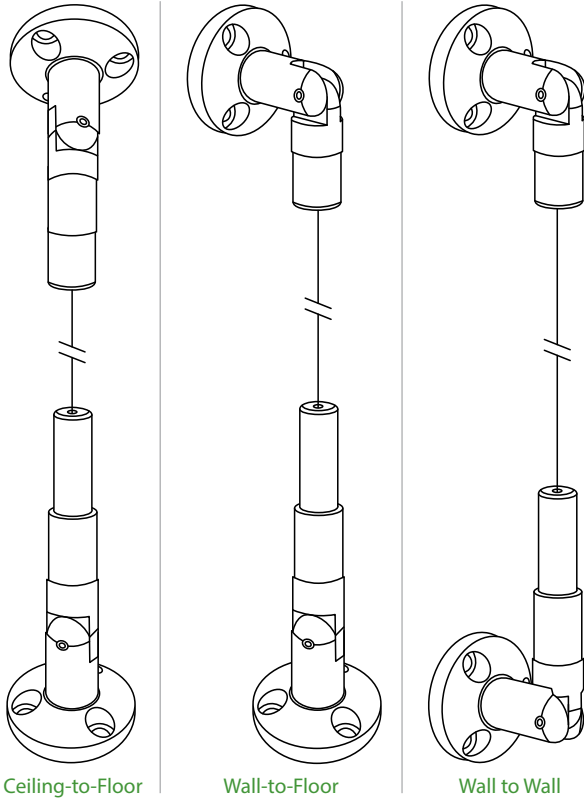

Ceiling-to-Floor

Wall-to-Floor

Wall to Wall



Universal Top Fitting

13' Stainless Steel Cable

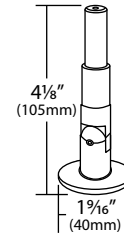

Universal Bottom Fitting



English measurements converted from metric. Metric is the most accurate.

Standard 1.5mm 3 in 1 Kit

MATERIAL = Aluminum (Fittings)
304 Grade Stainless Steel (Cable)

FINISH = Clear Anodized

- **Aluminum** universal fittings are hinged to allow or use in **Wall-to-Wall** and **Wall-to-Floor** applications
- For 8-1/2" x 11" and 11" x 17" graphics
- Can be used for single or double sided displays

Each Hardware Kit Contains:

- 1 universal top fitting
- 1 universal bottom fitting
- 1 cables - 13' length - 1.5mm thick (trimmable)

Part #

CSKE-GN-ALU

For 1.5mm: Horizontal Sign Clamps & Clear Acrylic Sign Holders, See Page C-50

Heavy Duty 3mm 3 in 1 Kit

MATERIAL = Solid Brass (Fittings)
304 Grade Stainless Steel (Cable)

FINISHES = Polished Chrome (*PC) & Satin Chrome (*SC)

- **Solid Brass** universal fittings are hinged to allow for use in **Wall-to-Wall**, **Wall-to-Floor** and **Floor-to-Ceiling** applications
- For 8-1/2" x 11" and 11" x 17" graphics
- Can be used for single or double sided displays

Each Hardware Kit Contains:

- 1 universal top fitting
- 1 universal bottom fitting
- 1 cables - 13' length - 3mm thick (trimmable)

Part #

CSK-FC-*

For 3mm: Horizontal Sign Clamps & Clear Acrylic Sign Holders, See Page C-51

Standard 1.5mm Ceiling to Floor Cable Signage

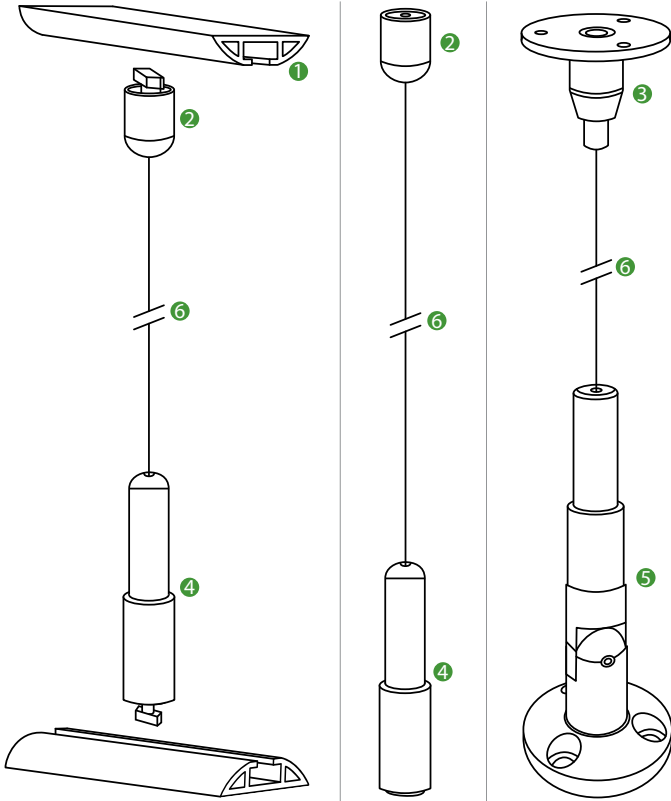

English measurements converted from metric. Metric is the most accurate.

1. Mounting Channel

CSK-ALU

Material: Aluminum
Finish: Clear Anodized
Cable Diameter: 1.5mm
Length: 6'6"



2. Channel/Ceiling Top Fitting

CSKE-CHTF-ALU

Material: Aluminum
Finish: Clear Anodized
Cable Diameter: 1.5mm

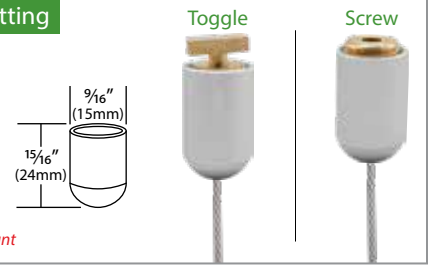

Comes with both toggle & screw mount

3. Ceiling Top Fitting

CSKE-CSTF-ALU

Material: Aluminum
Finish: Clear Anodized
Cable Diameter: 1.5mm



4. Channel/Floor Bottom Fitting

CSKE-CHBF-ALU

Material: Aluminum
Finish: Clear Anodized
Cable Diameter: 1.5mm

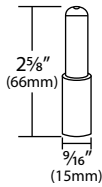

Comes with both toggle & screw mount

5. Bottom Fitting

CSKE-BF-ALU

Material: Aluminum
Finish: Clear Anodized
Cable Diameter: 1.5mm

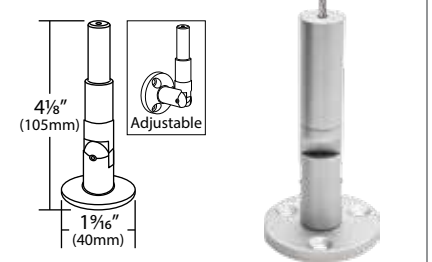

6. 1.5mm Bulk 304 Grade Stainless Steel Cables

Part #	Description	Cable Length	Carton Qty.
304 Stainless Steel Cables			
CSKE-CABLE	Standard 7x7 Construction	13'	50
Coated Stainless Steel Cables			
CSKE-CABLE-C	Nylon Coating Over 7x7 Cable	13'	50



Horizontal Sign Clamps

CSKE-SSGC-ALU

Material: Aluminum
Finish: Clear Anodized
Cable Diameter: 1.5mm

Use 3mm Hex Key

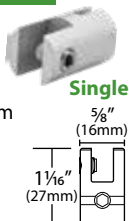

Double

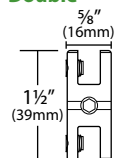

CSKE-DSGC-ALU

Material: Aluminum
Finish: Clear Anodized
Cable Diameter: 1.5mm

Use 3mm Hex Key

Clear Acrylic Sign Holder with Polished Edges

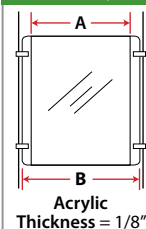

Part #	A (Graphic Size)	B (Overall Size)
CSK-ASH-7P	7"W x 11"H	8.25"W x 11"H
CSK-ASH-8P	8.5"W x 11"H	9.75"W x 11"H
CSK-ASH-8L	11"W x 8.5"H	12.25"W x 8.5"H
CSK-ASH-11P	11"W x 17"H	12.25"W x 17"H
CSK-ASH-11L	17"W x 11"H	18.25"W x 11"H
CSK-ASH-22P	22"W x 28"H	23.25"W x 28"H
CSK-ASH-22L	28"W x 22"H	29.25"W x 22"H

Heavy Duty 3mm Ceiling to Floor Cable System

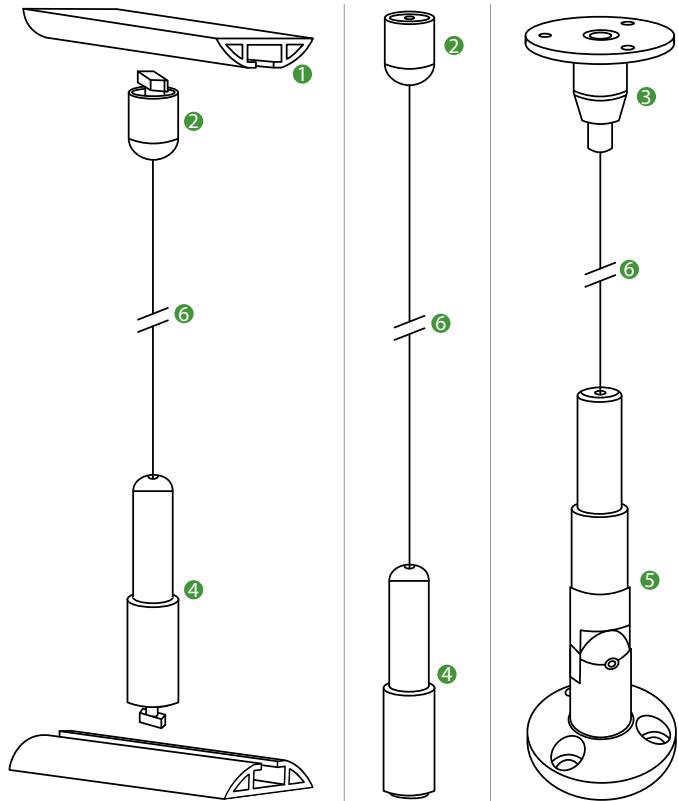

English measurements converted from metric. Metric is the most accurate.

1. Mounting Channel

CSK-ALU

Material: Aluminum
Finish: Clear Anodized
Cable Diameter: 3mm
Length: 6'6"



2. Channel/Ceiling Top Fitting

CSK-CHTF-SC

Material: Solid Brass
Finish: Satin Chrome
Cable Diameter: 3mm

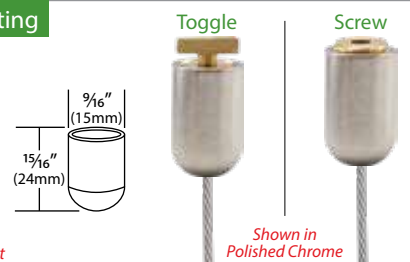

Comes with both toggle & screw mount

Shown in Polished Chrome

3. Ceiling Top Fitting

CSK-CSTF-*

Material: Solid Brass
Finish: Satin Chrome (*SC)
 & Polished Chrome (*PC)
Cable Diameter: 3mm



Shown in Polished Chrome

4. Channel/Floor Bottom Fitting

CSK-CHBF-*

Material: Solid Brass
Finish: Satin Chrome (*SC)
 & Polished Chrome (*PC)
Cable Diameter: 3mm

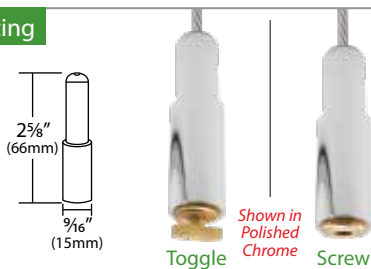

Comes with both toggle & screw mount

Toggle

Screw

5. Bottom Fitting

CSK-BF-*

Material: Solid Brass
Finish: Satin Chrome (*SC)
 & Polished Chrome (*PC)
Cable Diameter: 3mm

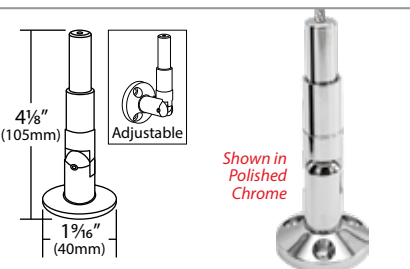

Shown in Polished Chrome

6. 3mm Bulk 304 Grade Stainless Steel Cables

Part #	Description	Cable Length	Carton Qty.
Stainless Steel Cables			
CSK-CABLE		13'	25
CSK-CABLE-26	Standard 7x7 Construction	26'	10
CSK-CABLE-100		100'	10
Coated Steel Cables			
CSK-CABLE-C	Nylon Coating Over 7x7 Cable	13'	25

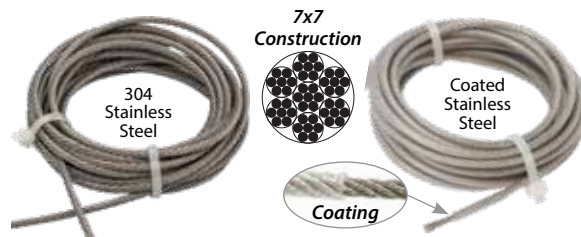

Horizontal Sign Clamps

CSK-SSGC-*

Material: Solid Brass
Finish: Satin Chrome (*SC)
 & Polished Chrome (*PC)
Cable Diameter: 3mm
 Use 3mm Hex Key

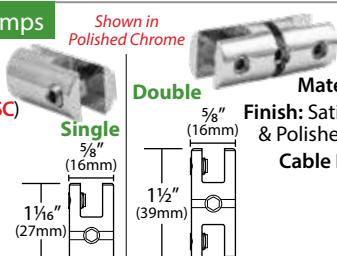

Shown in Polished Chrome

Single

Double

CSK-DSGC-*

Material: Solid Brass
Finish: Satin Chrome (*SC)
 & Polished Chrome (*PC)
Cable Diameter: 3mm
 Use 3mm Hex Key

Clear Acrylic Sign Holder with Polished Edges

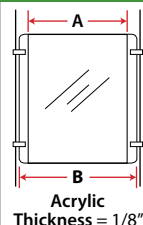

Part #	A (Graphic Size)	B (Overall Size)
CSK-ASH-7P	7"W x 11"H	8.25"W x 11"H
CSK-ASH-8P	8.5"W x 11"H	9.75"W x 11"H
CSK-ASH-8L	11"W x 8.5"H	12.25"W x 8.5"H
CSK-ASH-11P	11"W x 17"H	12.25"W x 17"H
CSK-ASH-11L	17"W x 11"H	18.25"W x 11"H
CSK-ASH-22P	22"W x 28"H	23.25"W x 28"H
CSK-ASH-22L	28"W x 22"H	29.25"W x 22"H

Standard 1.5mm Ceiling to Sign Cable Signage

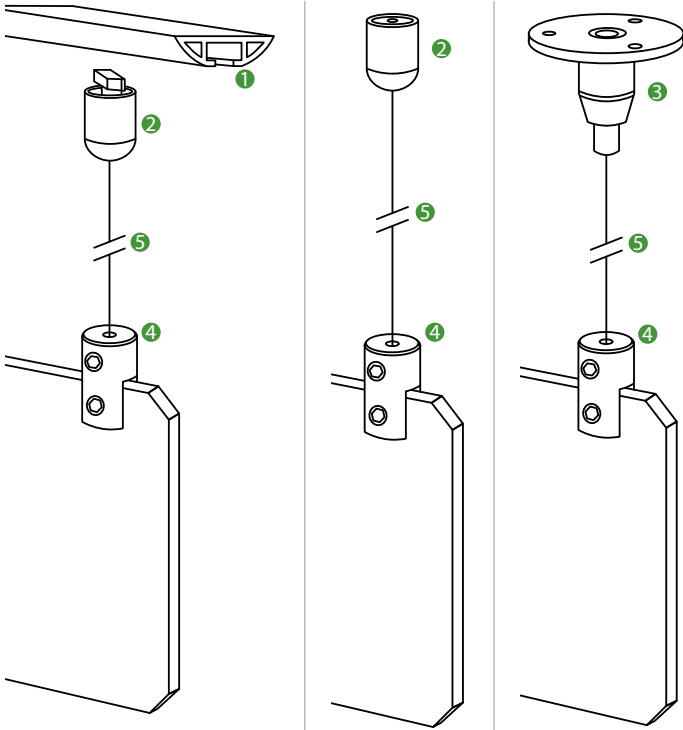

English measurements converted from metric. Metric is the most accurate.



1. Mounting Channel

CSK-ALU
 Material: Aluminum
 Finish: Clear Anodized
 Cable Diameter: 3mm
 Length: 6'6"

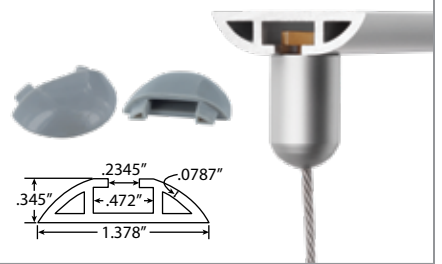

2. Channel/Ceiling Top Fitting

CSKE-CHTF-ALU
 Material: Aluminum
 Finish: Clear Anodized
 Cable Diameter: 1.5mm

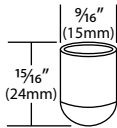

Comes with both toggle & screw mount

3. Ceiling Top Fitting

CSKE-CSTF-ALU
 Material: Aluminum
 Finish: Clear Anodized
 Cable Diameter: 1.5mm

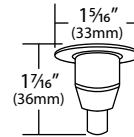

4. Sign Fitting (Holds 3/16" Thick Signage)

CSKE-CSSC-ALU
 Material: Aluminum
 Finish: Clear Anodized
 Cable Diameter: 1.5mm
 Use 3mm Hex Key

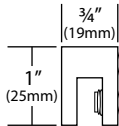

Vertical Double Sign Clamp

CSK-DSSC-PC
 Material: Solid Brass
 Finish: Polished Chrome
 Cable Diameter: 1.5mm
 Use 3mm Hex Key

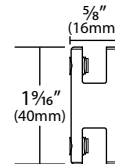

6. 1.5mm Bulk 304 Grade Stainless Steel Cables

Part #	Description	Cable Length	Carton Qty.
304 Stainless Steel Cables			
CSKE-CABLE	Standard 7x7 Construction	13'	50
Coated Stainless Steel Cables			
CSKE-CABLE-C	Nylon Coating Over 7x7 Cable	13'	50

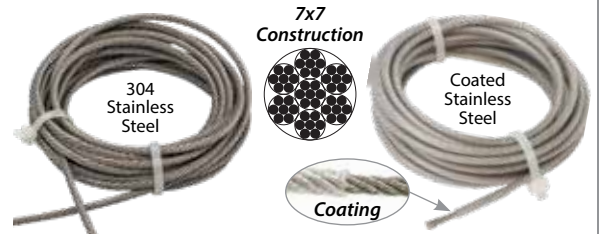

Heavy Duty 3mm Ceiling to Sign Cable System

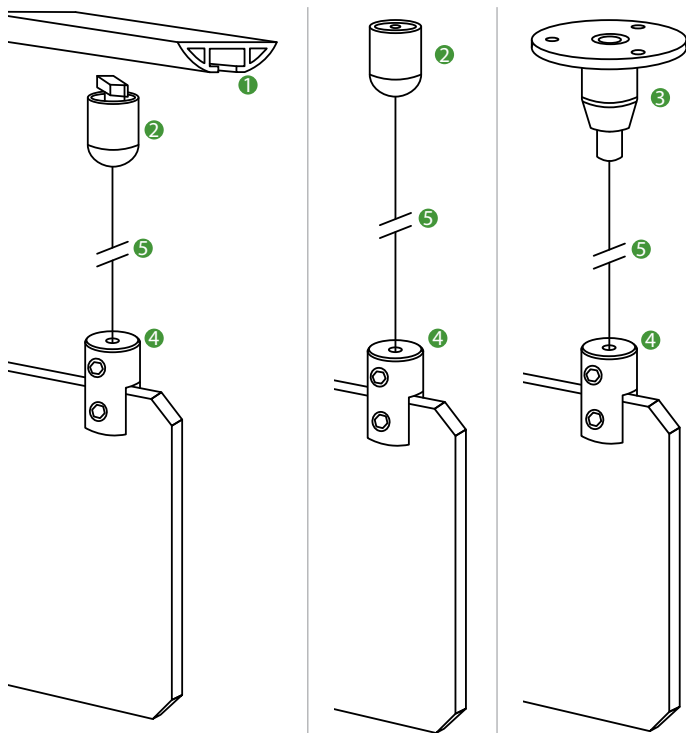

English measurements converted from metric. Metric is the most accurate.



1. Mounting Channel

CSK-ALU

Material: Aluminum
Finish: Clear Anodized
Cable Diameter: 3mm
Length: 6'6"

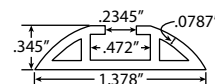

2. Channel/Ceiling Top Fitting

CSK-CHTF-SC

Material: Solid Brass
Finish: Satin Chrome
Cable Diameter: 3mm

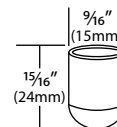

Toggle

Screw



Comes with both toggle & screw mount

Shown in Polished Chrome

3. Ceiling Top Fitting

CSK-CSTF-*

Material: Solid Brass
Finish: Satin Chrome (*SC)
 & Polished Chrome (*PC)
Cable Diameter: 3mm

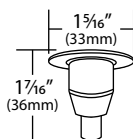

Shown in Polished Chrome

4. Sign Fitting (Holds 3/16" Thick Signage)

CSK-CSSC-*

Material: Solid Brass
Finish: Satin Chrome (*SC)
 & Polished Chrome (*PC)
Cable Diameter: 3mm
 Use 3mm Hex Key

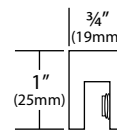

Shown in Polished Chrome



4. Sign Fitting (Holds 5/16" Thick Signage)

CSK-CSSC12-*

Material: Solid Brass
Finish: Satin Chrome (*SC)
 & Polished Chrome (*PC)
Cable Diameter: 3mm
 Use 3mm Hex Key

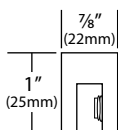

Shown in Polished Chrome



Vertical Double Sign Clamp

CSK-DSSC-PC

Material: Solid Brass
Finish: Polished Chrome
Cable Diameter: 1.5mm
 Use 3mm Hex Key

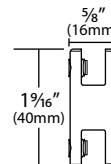

6. 3mm Bulk 304 Grade Stainless Steel Cables

Part #	Description	Cable Length	Carton Qty.
Stainless Steel Cables			
CSK-CABLE		13'	25
CSK-CABLE-26	Standard 7x7 Construction	26'	10
CSK-CABLE-100		100'	10
Coated Steel Cables			
CSK-CABLE-C	Nylon Coating Over 7x7 Cable	13'	25

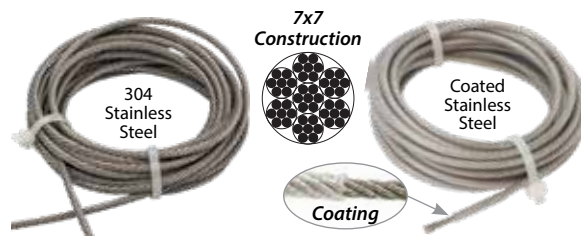

15 Series Cable Signage Kit Non-Illuminating



Complete Graphic Kit

MATERIAL = Aluminum (*Fittings*)
304 Grade Stainless Steel (*Cable*)

FINISH = Clear Anodized

- **Aluminum** universal fittings are hinged to allow or use in **Wall-to-Wall** and **Wall-to-Floor** applications
- For 8-1/2" x 11" and 11" x 17" graphics
- Can be used for single or double sided displays

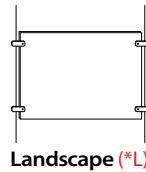
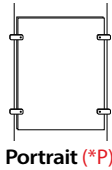

Each kit contains:

- 2 universal top fittings
- 2 universal bottom fittings
- 2 cables - 6' 6" length - 1.5mm thick (trimmable)
- 12 mounting screws & anchors
- 1 hex key
- 4 sign clamps per graphic holder
- 1/8" thick clear acrylic graphic holders w/polished edges

Hinged Fittings are adjustable:

Wall-to-Wall

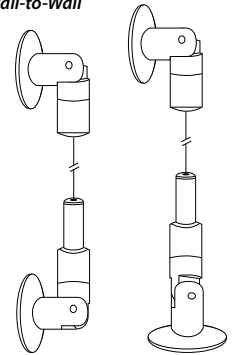

Wall-to-Floor

	Part #	Size	Type
2	CSKE-LITKIT2-8-*	8½" x 11"	Portrait (*P) Landscape (*L)
Graphic Kit	CSKE-LITKIT2-11-*	11" x 17"	
3	CSKE-LITKIT3-8-*	8½" x 11"	Portrait (*P) Landscape (*L)
Graphic Kit	CSKE-LITKIT3-11-*	11" x 17"	
4	CSKE-LITKIT4-8-*	8½" x 11"	Portrait (*P) Landscape (*L)
Graphic Kit	CSKE-LITKIT4-11-*	11" x 17"	

2 Graphic Kits

CSKE-LITKIT2-8-P
CSKE-LITKIT2-11-P

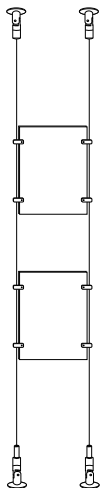

CSKE-LITKIT2-8-L
CSKE-LITKIT2-11-L

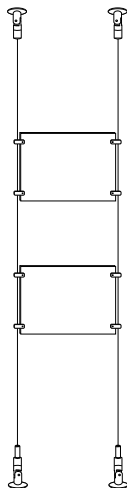

3 Graphic Kits

CSKE-LITKIT3-8-P
CSKE-LITKIT3-11-P

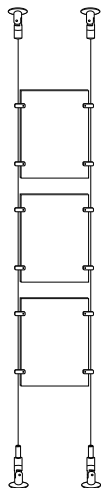

CSKE-LITKIT3-8-L
CSKE-LITKIT3-11-L

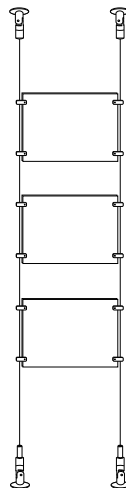

4 Graphic Kits

CSKE-LITKIT4-8-P
CSKE-LITKIT4-11-P

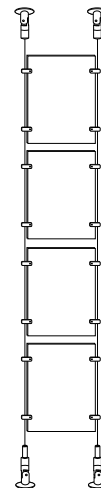

CSKE-LITKIT4-8-L
CSKE-LITKIT4-11-L

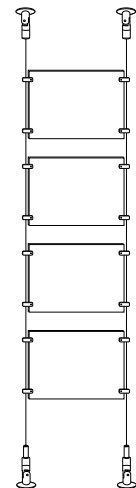

*Illuminate your signs
all night, without
breaking your budget!*

Complete Illuminating Graphic Kit

12V

MATERIAL = Solid Brass (Fittings)
304 Grade Stainless Steel (Cable)

FINISH = Polished Chrome

• **Solid Brass** universal fittings are hinged to allow for use in **Wall-to-Wall**, **Wall-to-Floor** and **Floor-to-Ceiling** applications

• For 8-1/2" x 11" and 11" x 17" graphics

• **Illuminated**



Hinged Fittings are adjustable:

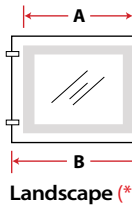
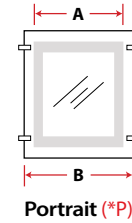
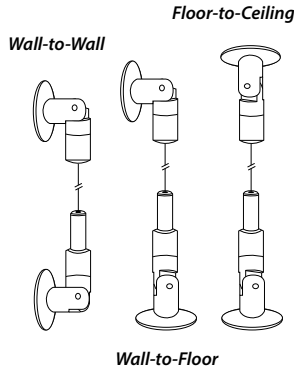

Each kit contains:

- 2 universal top and bottom fittings
- 2 cables - 13' length - 3mm thick (trimmable)
- 12 mounting screws & anchors
- 1 hex key
- 1 UL 12V power supply w/plug
- 1/8" thick clear acrylic graphic holders w/polished edges



Lighting Specifications

Color Temperature	Cool White CW: 6100K
Lumens	CSK-CLB-8*: 186 CSK-CLB-11*: 93
Color Rendering Index	CW: 70
Rated Average Life	CW: 50,000 hrs.
Constant	Voltage
Chip Size	SMD 2835



Part #	Graphic Size	A Reveal Dimensions (nominal)	B Overall Dimensions (nominal)	Total Wattage	Type	
2 Graphic Kit	CSK-ILITKIT2-8-* CSK-ILITKIT2-11-*	8-1/2" x 11" 11" x 17"	8-1/4" x 10-1/4" 10-3/8" x 16-3/8"	12-1/8" x 13-3/8" 13-1/2" x 19-1/2"	1.8W 3.6W	Portrait (*P) Landscape (*L)
3 Graphic Kit	CSK-ILITKIT3-8-* CSK-ILITKIT3-11-*	8-1/2" x 11" 11" x 17"	8-1/4" x 10-1/4" 10-3/8" x 16-3/8"	12-1/8" x 13-3/8" 13-1/2" x 19-1/2"	1.8W 3.6W	
4 Graphic Kit	CSK-ILITKIT4-8-* CSK-ILITKIT4-11-*	8-1/2" x 11" 11" x 17"	8-1/4" x 10-1/4" 10-3/8" x 16-3/8"	12-1/8" x 13-3/8" 13-1/2" x 19-1/2"	1.8W 3.6W	

2 Graphic Kits

CSK-ILITKIT2-8-P
CSK-ILITKIT2-11-P

CSK-ILITKIT2-8-L
CSK-ILITKIT2-11-L

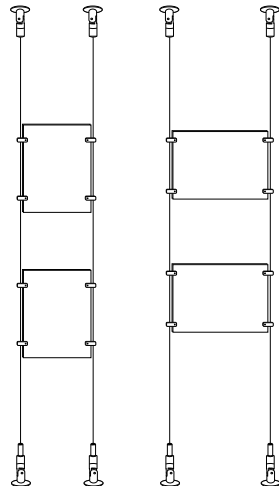

3 Graphic Kits

CSK-ILITKIT3-8-P
CSK-ILITKIT3-11-P

CSK-ILITKIT3-8-L
CSK-ILITKIT3-11-L

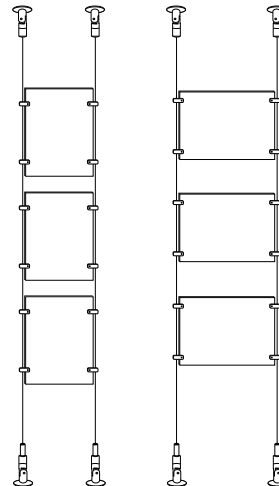

4 Graphic Kits

CSK-ILITKIT4-8-P
CSK-ILITKIT4-11-P

CSK-ILITKIT4-8-L
CSK-ILITKIT4-11-L

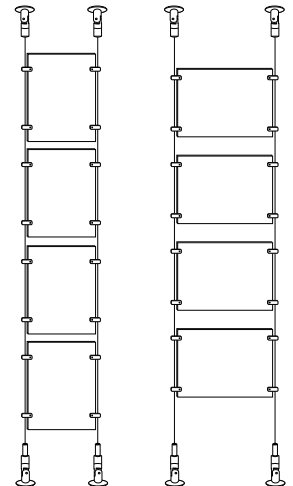

Insert and remove graphic from top



U-Shaped Cut Out



Can be set to varying heights



Beveled edge creates outer glow illumination!

Shelf Hardware Sets

MATERIAL = Solid Brass (*Fittings*), 304 Grade Stainless Steel (*Cable*)

FINISHES = Polished Chrome (***PC**), Satin Chrome (***SC**)

- Load Rating: 220 lbs. per cable



Wall-to-Wall



Includes:



Part #	Description
CSK-WWSH-6-*	w/ 6" Shelf Stabilizer
CSK-WWSH-8-*	w/ 8" Shelf Stabilizer

Note: 2 Sets needed for single unit display

Wall-to-Floor



Includes:



Part #	Description
CSK-WFSH-6-*	w/ 6" Shelf Stabilizer
CSK-WFSH-8-*	w/ 8" Shelf Stabilizer

Note: 2 Sets needed for single unit display

Floor-to-Ceiling



Includes:



Part #
CSK-FC-*

Note: 4 Sets needed for single unit display

A Few Examples of the Many Possible Shelving Configurations:

Wall-to-Wall

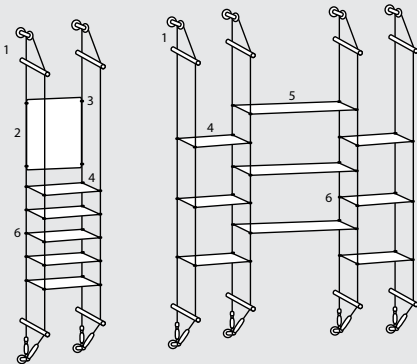

- 1 CSK-WWSH-*/Shelf Hardware Set pg. C-56
- 2 CSK-ASH-11P/Acrylic Sign Holder pg. C-51
- 3 CSK-SSGC/Horizontal Sign Clamp pg. C-51
- 4 CSK-SHF-1212/Clear Acrylic Flat Shelf pg. C-57
- 5 CSK-SHF-1224/Clear Acrylic Flat Shelf pg. C-57
- 6 CSK-SSC-*/Horizontal Shelf Clamp pg. C-57

Wall-to-Floor

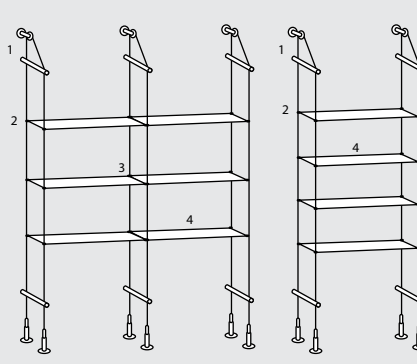

- 1 CSK-WFSH-*/Shelf Hardware Set pg. C-56
- 2 CSK-SSC-*/Horizontal Shelf Clamp pg. C-57
- 3 CSK-DSC-*/Double Horizontal Shelf Clamp pg. C-57
- 4 CSK-SHF-1224/Clear Acrylic Flat Shelf pg. C-57

Floor-to-Ceiling

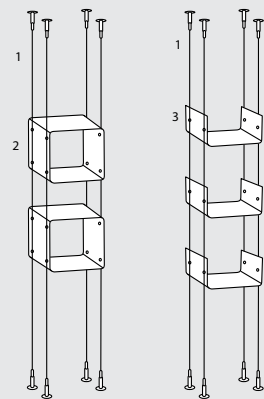

- 1 CSK-FC-*/Shelf Hardware Set pg. C-56
- 2 CSK-CUBE/Clear Acrylic Display Cube pg. C-57
- 3 CSK-FSHF-12/Clear Folded Acrylic Display Shelf pg. C-57

Acrylic Shelves

Clear Folded Acrylic Display Shelves with Polished Edges



ACRYLIC THICKNESS = 1/4" nominal

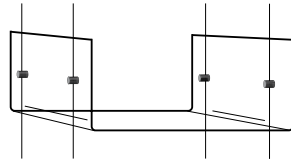

Polished Chrome Mounting Clamps Included

Part #	Overall Size
CSK-FSHF-12	12"D x 12"L x 6"H
CSK-FSHF-24	12"D x 24"L x 6"H

*Nominal Size

Clear Acrylic Display Cubes with Polished Edges



ACRYLIC THICKNESS = 1/4" nominal

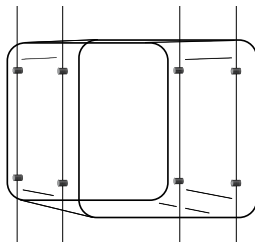

Polished Chrome Mounting Clamps Included

Part #	Overall Size
CSK-CUBE	12"W x 12"L x 12"D

*Nominal Size

Clear Acrylic Flat Shelves with Polished Edges



ACRYLIC THICKNESS = 1/4" nominal

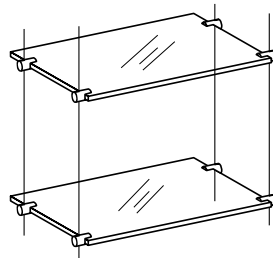

Shelf Clamps Sold Separately

Part #	Overall Size
CSK-SHF-1212	12"W x 12"D
CSK-SHF-1224	24"W x 12"D

*Nominal Size

Clear Acrylic Angled Shelves with Polished Edges

ACRYLIC THICKNESS = 1/4" nominal

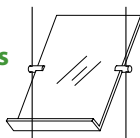

Part #	Overall Size
CSK-ASHF-9	9"W x 11-1/2"L x 1" Lip

Works with CSK-ADJ-* Adjustable Sign/Shelf Clamp

30 Series Shelf Clamps

Horizontal Shelf Clamps

MATERIAL = Solid Brass
FINISHES = Polished Chrome (*PC), Satin Chrome (*SC)

- Works with material up to 5/16" thick
- Use 3mm Hex Key

Part #	Type
CSK-SSC-*	Single
CSK-DSC-*	Double

Single

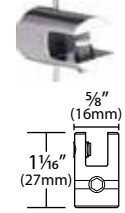

Double

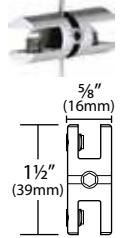

Adjustable Sign/Shelf Clamps

MATERIAL = Solid Brass
FINISHES = Polished Chrome (*PC), Satin Chrome (*SC)

- Rotates for sign or shelf applications
- Works with material up to 5/16" thick
- Use 3mm Hex Key

Part #
CSK-ADJ-*



Undermount Shelf Support

MATERIAL = Solid Brass
FINISHES = Polished Chrome (*PC), Satin Chrome (*SC)

- Shelf support for use under drilled or slotted shelves
- Works with material up to 5/16" thick
- Hole Size: 5/16" - 3/8" (8-10mm)
- Slot Size: 1/8" (3.5mm)
- Use 3mm Hex Key

Part #
CSK-UM-*

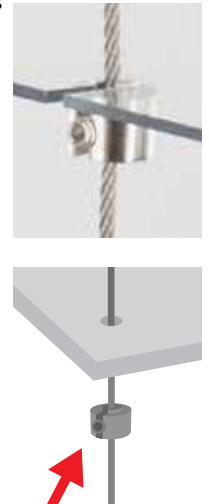
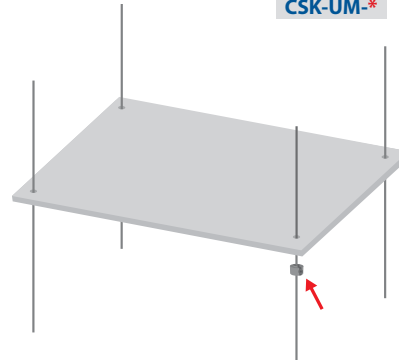

Optional Cable Display Accessories

Hex Keys

- Set of 3 hex keys M4, M5 & M6



Part #
CSK-HEX

Cable Cutter



Part #
CSK-CUTTER

Adjustable Cable Hook Sign Hanging Hardware

Locking Adjustable Cable Hook Kit w/Top Fitting

- **Material:**
304 Grade Stainless Steel Cable with Polished Chrome Steel Hook & Top Fitting
- **Wire Gauge:**
1.5mm

44 HOLDS
LBS. per
cable
assembly

Field Cuttable to Any Length

Mounting Screw Not Included
Toggle Option Available,
Please Inquire

Kit Includes:

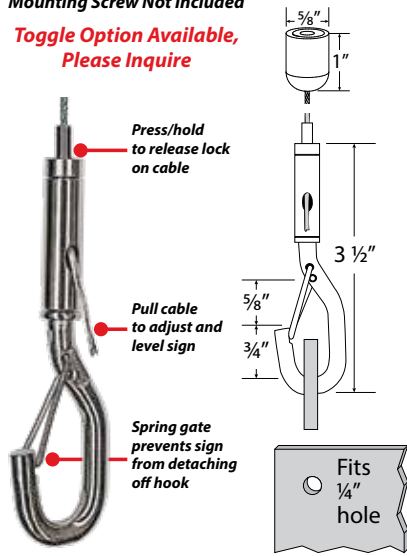

Part #	Description
FWH-8-PC	8 ft. Cable
FWH-15-PC	15 ft. Cable

Locking Adjustable Cable Hook Kit w/2" Loop End

- **Material:**
304 Grade Stainless Steel Cable with Polished Chrome Steel Hook & Top Fitting
- **Wire Gauge:**
1.5mm

44 HOLDS
LBS. per
cable
assembly

Field Cuttable to Any Length

Kit Includes:

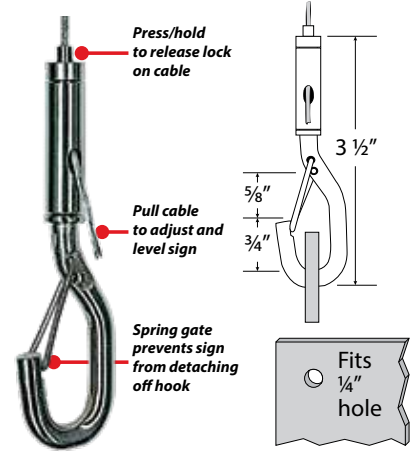
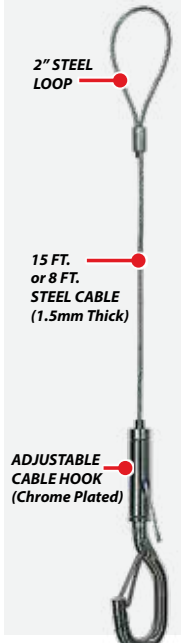

Part #	Description
GSH-8	8 ft. Cable
GSH-15	15 ft. Cable

Double Loop Cables

3MM 304 Grade Stainless Steel Cable w/ 2 Loops



Part #	Length	Carton Qty.
LRF-CLP6-1	1'	25
LRF-CLP6-18	18"	25
LRF-CLP6-2	2'	25
LRF-CLP6-3	3'	25
LRF-CLP6-4	4'	25
LRF-CLP6-6	6'	25

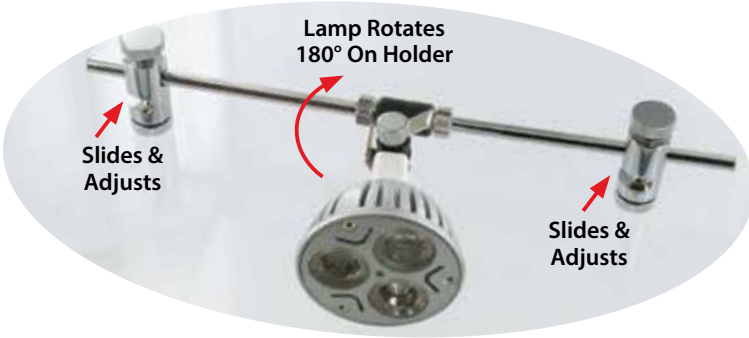

12V
MATERIAL = Polished Chrome Steel

- Works With Any 30 Series Cable System
- 180° Rotation of lamp holder
- Built in heat sink
- Energy efficient
- Adjustable
- MR16, 5W bulb included

**As Bright As A
 50W
 Halogen Bulb**

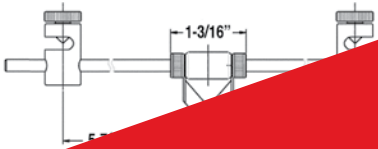

DISCONTINUED
 PLEASE CALL ONE OF OUR SALES ASSOCIATES FOR OTHER OPTIONS

Lighting Specifications

Color Temperature	CW: 5500K-6500K WW: 2700K-3500K
Beam Spread	30°
Lumens	CW: 340 WW: 290
Color Rendering Index	WW: 75 CW: 80
Rated Average Life	CW/WW: 30,000-50,000 hrs.
Constant	Voltage
Chip Size	SMD2835

	Width Adjusts From:	# Of LED Chips	Total Wattage
White	5-7/8" to 7-7/8"	4	5W
Cool White			
WW	11-13/16" to 15-3/4"		
16-200-CW			

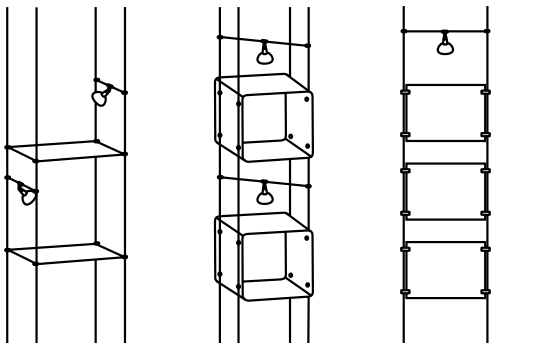

Works with our Cable Display System, see pgs. C-56~57



Power Supply (3A / 12V / 36W)

- 3.41" L x 2.31" W x 1.26" H
- 18AWG Output Cord: 6'
- Polarized 2 Prong Plug

LED-12V-3A

Picture & Art Hanging Systems

Our hanging systems allows you to easily add, reposition/remove art or wall objects without wall damage.

- Hanging & display solutions for residential & commercial use
- Easy to adjust and change artwork
- Eliminates wall repairs and repainting
- No tools needed
- Aluminum track load capacity: 110 lbs. per length
- Nylon cable load capacity: 33 lbs. per length
- Stainless cable load capacity: 44 lbs. per length



1 Select Your Channel



2 Select Your Vertical Cables



3 Select Your Picture Hooks

New! Click Track

Versatile • Discreet • Easy to Install

The Click Track is secured to the wall using click buttons that conceal all fittings and wall anchors

Secure Click Buttons to Wall



Track Attaches to Click Buttons

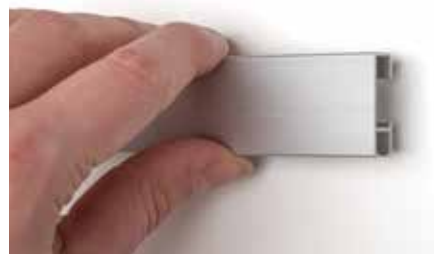

Slide Fitting in to Track & Install End Cap



Channels For Cables With Top Hooks

1. Click Track

GPX-TK100-*

Finish: Black (*BK),
White (*WH) & Satin (*S)

Cable Diameter: 2mm

Length: 6'



Included:
2 End Caps,
3 Click Buttons
& 1 Splicer

2. Wall Track

GPX-TK101-*

Finish: Black (*BK),
White (*WH) & Satin (*S)

Cable Diameter: 2mm

Length: 6'



3. Ceiling Track

GPX-TK102-*

Finish: Black (*BK),
White (*WH) & Satin (*S)

Cable Diameter: 2mm

Length: 6'



4. J Track

ALU851-*

Finish: Black (*BK),
White (*WH), Satin (*S),
Mill (*M) & Polished (*P)

Cable Diameter: 2mm

Length: 12'



Holes
Approx.
4" Spacing

Part #	Mill (*M)	Polished (*P)	Satin (*S)	Black (*BK)	White (*WH)
ALU851-*	-	-	-	-	-

Accessories

Hex Keys

CSK-HEX



Cable Cutter

CSK-CUTTER



Large Picture Stabilizer

Recommended for pictures
16" x 16" and up

GPX-HK13-NP



Vertical Cables



Part #	Description	Cable Material	Length	Carton Qty.
1 GPX-T48-N	T-End Cable	Nylon	48"	50
1 GPX-T120-N	T-End Cable Work With Track: GPX-TK100-*	Stainless	120"	50
1 GPX-T48-SS		Steel	48"	50
1 GPX-T120-SS	T-End Cable	Steel	120"	50
2 GPX-B48-SS	Ball End Cable	Stainless	48"	50
2 GPX-B120-SS	Ball End Cable Work With Track: GPX-TK100-*	Steel	120"	50
3 GPX-V48-SS	V-End Cable	Stainless	48"	50
3 GPX-V120-SS	V-End Cable Work With Track: ALU851-*	Steel	120"	50
4 GPX-P48-N	P-End Cable	Nylon	48"	50
4 GPX-P120-N	P-End Cable Work With Tracks: GPX-TK101-*, GPX-TR102-* & ALU851-*	Stainless	120"	50
4 GPX-P48-SS		Steel	48"	50
4 GPX-P120-SS	P-End Cable	Steel	120"	50
5 GPX-H48-N	Hex End Cable	Nylon	48"	50
5 GPX-H120-N	Hex End Cable Work With Track: GPX-TK100-*	Stainless	120"	50
5 GPX-H48-SS		Steel	48"	50
5 GPX-H120-SS	Hex End Cable	Steel	120"	50

Picture Hooks



Part #	Description	Finish	Carton Qty.
1 GPX-HK5-NP	Self Gripping Hook	Bright Nickel	50
2 GPX-HK6-NP	L-End Hook		50
3 GPX-HK8-NP	Smart Spring		50
4 GPX-HK9-NP	Spring Hook		50
5 GPX-HK58-NP	Self Locking Hook		50
6 GPX-HK7-NP	Self Gripping Hook		50
7 GPX-HK3-NP	L Hook		50
8 GPX-HK1-NP	J-End Hook		50

Trackless 2mm Cable Hanging System For Wall & Ceiling

Option 1: Stand Alone 2mm Cables

1. Adjustable Hinged Fitting Cable

Mounts on Walls & Ceilings



2. Standoff End Cable

Mounts on Walls



	Part #	Cable Material	Length	Ctn. Qty.
1	GPX-ADJ48-N	Nylon	48"	50
1	GPX-ADJ120-N		120"	50
1	GPX-ADJ48-SS	Stainless Steel	48"	50
1	GPX-ADJ120-SS		120"	50
2	GPX-STD48-N	Nylon	48"	50
2	GPX-STD120-N		120"	50
2	GPX-STD48-SS	Stainless Steel	48"	50
2	GPX-STD120-SS		120"	50

Option 2: Bulk 2mm Cable - Make Your Own

2MM Nylon Cable

[GPX-CABLE-100](#)

Material: Nylon
Cable Diameter: 2mm
Length: 100'



Economy Cable Looper

[GPXE-HK41-M](#)

Material: Aircraft Grade Aluminum
Finish: Mill
Cable Diameter: 2mm



Cable Looper

[GPX-HK41-NP](#)

Material: Solid Brass
Finish: Bright Nickel
Cable Diameter: 2mm



Economy Cable Looper



Cable Looper

Option 3: Premade Single Loop 2mm Cable with Ferrule



Nylon



Stainless Steel

	Part #	Material	Length	Ctn. Qty.
	GPX-L48-N	Nylon	48"	50
	GPX-L120-N		120"	50
	GPX-L48-SS	Stainless Steel	48"	50
	GPX-L120-SS		120"	50

Trackless 2mm Cable Hanging System For Wall & Ceiling

Mounting Options For 2mm Cable

1 S-Hook



▲ Works With
ALU851-*

2 Picture
Frame Hook



3



4



Fits Standard Ceiling Grids

	Part #	Description	Finish	Ctn. Qty.
1	GPX-HK10-NP	S-Hook	Bright Nickel	50
2	GPX-HK11-WW	L-End Hook	White	50
3	1215	Standard Twist Clip	White & Zinc	100
4	1216	Threaded Twist Clip	Plated Steel	100

Picture Hooks For 2mm Cable

1



2



3



4



5



6



7



8



	Part #	Description	Finish	Ctn. Qty.
1	GPX-HK5-NP	Self Gripping Hook	Bright Nickel	50
2	GPX-HK6-NP	L-End Hook	Bright Nickel	50
3	GPX-HK8-NP	Smart Spring	Bright Nickel	50
4	GPX-HK9-NP	Spring Hook	Bright Nickel	50
5	GPX-HK58-NP	Self Locking Hook	Bright Nickel	50
6	GPX-HK7-NP	Self Gripping Hook	Bright Nickel	50
7	GPX-HK3-NP	L Hook	Bright Nickel	50
8	GPX-HK1-NP	J-End Hook	Bright Nickel	50

Accessories For All Cables

Hex Keys



Cable Cutter



Large Picture Stabilizer

Recommended for pictures 16" x 16" and up



Apartment Hanger

HGHB-APT-*

- **Material:** Aluminum
- No drill, easy to install
- Foam liner, so no damage to walls
- Wall bracket holes drilled every inch
- Patented/Made in USA

The Hangman Apartment Hanger consists of two aluminum interlocking brackets modeled after the French Cleat featuring a built-in level which ensures an accurate installation. The aircraft grade aluminum brackets will not corrode and can be used indoors or outdoors. The system uses small nails which leave pin size holes and a foam back to protect walls from scuffs and marks. Once installed it can be adjusted left or right.



Part #	Size	Load Rating	Hardware Includes: (1) Wall Bracket, (1) Mounting Bracket, (1) Bubble Level,	
			#8 x 5/8" Screws	Nails
HGHB-APT-6	6" Long	50 lbs.	2	5
HGHB-APT-12	12" Long	100 lbs.	3	14
HGHB-APT-18	18" Long	150 lbs.	5	20

Heavy Duty Mirror & Picture Hanger

HGHB-HM-*

- **Material:** Aluminum
- Wall bracket holes drilled every inch
- Brackets are angled to ensure a flush mount
- Patented/Made in USA

The Hangman Heavy Duty Mirror & Picture Hanger is our classic and best selling product. It consists of two aluminum interlocking brackets modeled after the French Cleat featuring a built-in level which ensures an accurate installation. The aircraft grade aluminum brackets will not corrode and can be used indoors or outdoors on all surfaces. The system includes walldog anchorless fasteners.



Part #	Size	Load Rating	Hardware Includes: (1) Wall Bracket, (1) Mounting Bracket, (1) Bubble Level,	
			#8 x 5/8" Screws	Walldog Screws
HGHB-HM-6	6" Long	75 lbs.	2	2
HGHB-HM-10	10" Long	100 lbs.	3	3
HGHB-HM-12	12" Long	100 lbs.	3	3
HGHB-HM-18	18" Long	200 lbs.	5	5
HGHB-HM-30	30" Long	300 lbs.	8	8
HGHB-HM-42	42" Long	300 lbs.	10	10

Professional French Cleat Hanger

HGHB-CBH-*

- **Material:** Aluminum
- Two piece system includes inset mounting bracket for a flush fit
- Aircraft grade aluminum
- Patented/Made in USA

The Hangman Professional French Cleat Hanger is a variation of the Heavy Duty Hangman and has several unique features. The overlapping design of the mounting bracket provides high torque leverage for use in hanging cantilevered shelves. The wall track is punched every inch making it easy to hit at least one stud. In addition to hanging shelves, it works great on cabinets, mirrors, and other heavy wall décor.



Part #	Size	Load Rating	Hardware Includes: (1) Wall Bracket, (1) Mounting Bracket, (1) Bubble Level,	
			#8 x 5/8" Screws	Walldog Screws
HGHB-CBH-18	18" Long	200 lbs.	5	5
HGHB-CBH-30	30" Long	300 lbs.	8	8
HGHB-CBH-42	42" Long	300 lbs.	10	10

Self Leveling Flushmount Hanger

HGHB-SCH-2

- **Material:** Aluminum
- Inset for a flush fit
- Aircraft grade aluminum
- Patented
- Works well with open back canvas

The Hangman Self Leveling Flushmount Hanger is a single piece hanger that attaches to the back of your canvas and hangs on the provided Bear Claw Hanger. The inset created allows the canvas to hang flush against the wall. Ideal for unframed canvas art. Also works on wooden frames.



Hardware Includes:

- (2) #4 x 5/8" Screws
- (2) Double Headed Bear Claw Screws
- (2) Sawtooths

Part #	Size	Load Rating
HGHB-SCH-2	38 x 22 mm	20 lbs.

Canvas Hanger

HGHB-CH-5

- **Material:** Aluminum
- Brackets are angled to ensure a flush mount
- Patented/Made in USA

The Hangman Canvas Hanger is a two piece bracket system that hangs giclees, gallery wraps, canvas or open back frames flush to the wall.

The wall track includes a bubble level for an accurate installation.



Hardware Includes:

- (2) #4 x 5/8" Screws
- (2) #8 x 1" Screws
- (1) Bubble Level
- (1) Mounting Bracket
- (1) Wall Bracket

Part #	Size	Load Rating
HGHB-CH-5	5" Long	20 lbs.

Aluminum Frame Hanger

HGHB-ALH-5

- **Material:** Aluminum
- Offset almost flush
- Single piece wall hanger

The Hangman Aluminum Frame Hanger is a one bracket system that is designed to hook into standard aluminum frames or specially designed wooden frames with an undercut.

The track includes a bubble level and anchorless Walldog fasteners for a fast and accurate installation.



Hardware Includes:

- (2) Walldog Screws
- (1) Bubble Level
- (1) Frame Hanger

Part #	Size	Load Rating
HGHB-ALH-5	5" Long	60 lbs.

Z-Hanger

HGZ-6948-* Z-Hanger

HGZL-6986-* Z-Lite Hanger

- **Material:** Aluminum
- **Load Rating:** 100 lbs. per ft. (HGZ-6948-*)
60 lbs. per ft. (HGZL-6986-*)
- Offset .22" (5.6 mm)
- Alternating holes every 1" (3/16" dia. & 1/4" dia.)
- Sold as pairs, including:
1" walldog screws & 5/8" bear claw screws
- HGZL-6986-*. Slight flexibility allows for easier engagement on non-plumb walls
- Sold in full cases only, where indicated (■)

The Hangman Z-Hanger consists of two aluminum interlocking brackets modeled after the French Cleat. The aircraft grade aluminum brackets will not corrode and can be used indoors or outdoors on all surfaces. The system is compatible with various fasteners, and can be adjusted left or right. Hangman's unique Z-Hanger comes with alternating holes punched every inch.



Part #	Size	Load Rating	Hardware Includes: (1) Wall Bracket, (1) Mounting Bracket,		Case Quantity
			#8 x 5/8" Screws	Walldog Screws	
HGZ-6948-18	18" Long	120 lbs./ft.	5	5	-
HGZ-6948-30	30" Long	120 lbs./ft.	8	8	-
■ HGZ-6948-18-12	18" Long	120 lbs./ft.	Hardware Not Included		6 sets
■ HGZ-6948-30-12	30" Long	120 lbs./ft.	Hardware Not Included		6 sets
■ HGZL-6986-18-12	18" Long	60 lbs./ft.	Hardware Not Included		6 sets
■ HGZL-6986-30-12	30" Long	60 lbs./ft.	Hardware Not Included		6 sets

Z-Man Mounting Bracket

HGZM-6318-*

- **Material:** Aluminum
- Slight flexibility allows for easier engagement on non-plumb walls
- Aircraft grade aluminum
- Alternating holes every 1" (3/16" dia. & 1/4" dia.)
- Easily cuttable with a carbide tip saw
- **Load Rating:** 60 lbs. per ft.
- Sold in full cases only,
6 sets/case



Hardware Not Included

Part #	Size	Load Rating
HGZM-6318-18-12	18" Long	60 lbs./ft.
HGZM-6318-30-12	30" Long	60 lbs./ft.

Machine Thread Double-Headed Screw

HGSCR-MT-*

- **Material:** Steel
- #10-24 x 2-1/4" Long
- Machine screw threading
- Double-headed hanging surface
- **Load Rating:** 100 lbs.
- Works w/Toggler TA-1013 snap-toggle
- *Sold in full cases only*

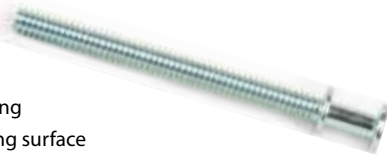

Part #	Case Quantity
HGSCR-MT-10P	10 pcs.
HGSCR-MT-100	100 pcs.
HGSCR-MT-1000	1000 pcs.

Walldog Screws

HGSCR-WDS-*

- **Material:** Steel
- 1-1/4" Screws
- #8 Pan head
- Hi-Lo thread, 1/4" bore hole
- **Load Rating:** 60 lbs. shear, 40 lbs. tension in drywall
- *Sold in full cases only*



The Hangman Walldog Screws are an all steel, one piece, threaded fastener, which is used to fasten various fixtures directly to drywall. Walldog fasteners are fast. Unlike conventional screw anchors, which require the secondary step of threading a sheet metal screw into an anchor, the Walldog is installed directly through the fixture into the drywall.

Part #	Case Quantity
HGSCR-WDS-100	100 pcs.
HGSCR-WDS-1000	1000 pcs.

Walldog Safety Hanger

HGSH-WDH-*

- **Material:** Aluminum
- Aircraft grade aluminum
- Security lip prevents wire from slipping out
- 8 wide pivot point prevents frames from slipping
- Patented/Made in USA

The Hangman Walldog Safety Hanger is an extruded aluminum track that has a security lip to prevent picture hanging wire from slipping out. The wire is easy to insert and won't come out if bumped. The brackets are installed using anchorless Walldog fasteners that require no drilling and no stud. Friction bumpers included to keep walls clean and keep art from shifting.



Part #	Length	Load Rating	Hardware Includes:
HGSH-WDH-40	1-1/2"	40 lbs.	(1) Walldog, (1) Pair Bumper, (1) Hanger
HGSH-WDH-80	3"	80 lbs.	(2) Walldogs, (1) Pair Bumper, (1) Hanger

Bear Claw Hanger

HGSCR-*

- **Material:** Steel
- Self-drilling tip, no pilot hole required
- Works with D-rings, wire, keyhole & sawtooths
- **Load Rating:** 30 lbs. drywall, 100 lbs. stud
- *Sold in full cases only*

The Hangman Black Bear Claw Hangers work with D-rings, wire, sawtooths and keyholes for simple mirror and picture hanging solutions. Installs with a hand-held Phillips screwdriver. Self-drilling tip for easy installation.

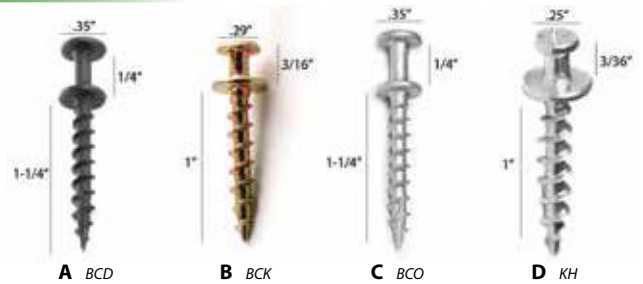

	Part #	Length	Description	Case Quantity
	HGSCR-BCD-10P			10 pcs.
A	HGSCR-BCD-100	#8 x 1-1/4"	Black Oxide	100 pcs.
	HGSCR-BCD-1000			1000 pcs.
	HGSCR-BCK-10P			10 pcs.
B	HGSCR-BCK-100	#8 x 1"	Zinc Plated	100 pcs.
	HGSCR-BCK-1000			1000 pcs.
	HGSCR-BCO-10P		Special	10 pcs.
C	HGSCR-BCO-100	#8 x 1-5/8"	Outdoor	100 pcs.
	HGSCR-BCO-1000		Coating	1000 pcs.
	HGSCR-KH-10P			10 pcs.
D	HGSCR-KH-100	#8 x 1"	.25" Head Size	100 pcs.
	HGSCR-KH-1000			1000 pcs.

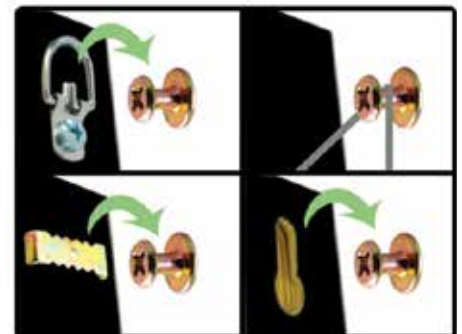

Christmas Light Hangers

HGSH-QH-*

- **Material:** Stainless Steel
- Screws have an open loop (5/32" opening)
- **Load Rating:** 100 lbs. in wood beam or stud
- *Sold in full cases only*

The Hangman Christmas Light Hangers are an all year outdoor stainless steel wire holder. A simple way to hang holiday lights, bird feeders, bird houses, wind chimes, etc. Installs easily and is wind and weather resistant with a lifetime warranty. These are made to last.

Part #	Size	Case Quantity
HGSH-QH-12	38 x 22 mm	12 pcs.
HGSH-QH-20		20 pcs.



Elephant Hook Ceiling Hook

- **Material:** Steel
- Weather resistant coating
- Swivels & locks
- **Load Rating:** Holds 20 lbs. in drywall, 100 lbs. in wood

Elegant and easy, the Elephant Hook ceiling hook installs in under a minute. No drilling or pilot hole necessary. Simply screw in the self-drilling double-headed Bear Claw Hanger. Snap the Elephant Hook in place over the exposed collar. Swivel to desired angle and allow the weight of your item to lock into place. Comes in three finishes to match decor. For use indoor or outdoors, holds 100 lbs. in wood, 20 lbs. in drywall.

Hardware Includes:

- (1) Elephant hook
- (1) #8 x 1-1/4" Double-headed screw
- (1) Snap screw

Part #	Finish
HGH-EH-B	Bronze
HGH-EH-N	Nickel
HGH-EH-W	White



HGH-EHO-N Nickel



HGH-EHO-B Bronze



HGH-EHO-W White

Push and Hang

HGSH-PSH-*

- **Material:** Steel Plating
- Pushed directly into drywall
- Creates an easy hanging surface
- *Sold in full cases only*

Push and hang. Absolutely the simplest and easiest to use picture hanger on the planet! Simply push into drywall, no tools needed.

Part #	Size	Load Rating	Case Quantity
HGSH-PSH-S-100	9 x 26 mm	10 lbs.	100 pcs.
HGSH-PSH-S-1000			1000 pcs.
HGSH-PSH-L-100	16 x 35.5 mm	20 lbs.	100 pcs.
HGSH-PSH-L-1000			1000 pcs.



Furniture Anti-Tip Kit

HGA-TK-400

- **Material:** Steel
- Aircraft grade steel cables
- Secures dressers, curio cabinet, chests and entertainment centers
- **Load Rating:** 400 lbs.
- Also available for leaner mirrors

The Hangman Furniture Anti-Tip Kit consists of an aircraft grade steel cable that connects on one end to your furniture with a bracket installed into a stud on the wall. The cable prevents the furniture from tipping over. This kit is a leader in furniture safety.



HGA-TK-400



Hardware Includes:

- (2) #8 x 5/8" Screws
- (2) #8 x 1-1/2" Screws
- (2) Steel Brackets
- (2) Clevis Pins
- (2) Hair Pins
- (1) 6" Stainless Steel Cable

No Stud TV Hanger

HGA-S2040-A

- **Material:** Aluminum
- Built-in level
- Hangs 26" - 55" flat screen TV's
- 1" Clearance from the wall
- No stud, no anchors required
- Won't damage walls, installs with tiny picture hanging nails
- Installs in 10 minutes
- Security cable included
- Black anodized finish
- UL rated to hold 80 lbs.
- Easy tilt for access to cables
- Only tools required are a hammer and a screwdriver
- Bracket length is 18"

The Hangman No Stud TV Hanger will hang any LED thin screen TV in less time than it takes to unpack it. Consists of two 18" interlocking aircraft-grade aluminum brackets. One bracket attaches to the back of the TV and the other bracket installs on the wall. Once installed a 1" clearance from the wall provides easy access and space for cords and cables. The wall track has a foam backing to minimize wall damage. Once removed all that is left behind are tiny pinholes that can be easily covered up. Comes in Black Anodize Finish. Patented & UL Rated.



Here's How It Works

Our Light but Strong Materials Are Of The Highest Quality

NO DRILLING OR ANCHORS
WOULDN'T DAMAGE WALLS
ACTUAL NAIL & WALL HOLE SIZE



AIRCRAFT-GRADE
BRACKETS INTERLOCK



Hardware Includes:

- (1) 18" TV mount bracket
- (1) 18" wall bracket
- Hardware

HGA-S2040-A

Gallery Track

HGGS-GT-*

- Material: Aluminum
- Paintable

The Hangman Gallery Track is a part of Hangman's new gallery track system. They are a professional system that can be used at home or the office. Enjoy the ease of changing frames whenever you desire without damaging your walls. Available in 2', 3', 4', 6' and 8' lengths.



Part #	Length	Hardware Includes: (1) Connector, (1) Pair of End Caps, +
HGGS-GT-24	24"	(2) #8 x 1-1/2" Screws, (2) Anchors, (2) Sliders
HGGS-GT-36	36"	(2) #8 x 1-1/2" Screws, (2) Anchors, (3) Sliders
HGGS-GT-48	48"	(3) #8 x 1-1/2" Screws, (3) Anchors, (4) Sliders
HGGS-GT-72	72"	(3) #8 x 1-1/2" Screws, (3) Anchors, (6) Sliders
HGGS-GT-96	96"	(3) #8 x 1-1/2" Screws, (3) Anchors, (8) Sliders

Accessories for Gallery Track

GALLERY HOOKS

- Material: Chrome Plated Zinc
- Tension hooks grip when pulled down
- Push button to move upwards



HGGS-GT-H

GALLERY WIRE

- Material: Chrome Plated Zinc
- High Grade Wire
- Works only with our gallery track
- Can be coiled to control length
- Available in 8' lengths



HGGS-GT-8W 8 ft. Length

GALLERY HANGING BRACKET

- Material: Chrome Plated Zinc
- Works only with our gallery track
- Slides left or right for positioning
- Holds our gallery track cables

HGGS-GT-SL



GALLERY TRACK CONNECTOR

- Material: Chrome Plated Zinc
- Makes aligning tracks easy

HGGS-GT-C



GALLERY TRACK END CAPS

- Material: Plastic
- Gives a finished look

HGGS-GT-EC



**PORTABLE,
SETS UP IN SECONDS!**

- Holds 8-1/2" x 11" literature and brochures
- Locking mechanism will securely keep unit in upright position while in use
- Canvas carry bag included

ZIG ZAG STYLE

MATERIAL: Aluminum & Steel W/Acrylic Shelves

Product Dimensions:

- Set up:** 11-1/8" W x 57-1/4" H x 10-3/4" D
Folded: 11-1/8" W x 4-1/2" H x 15-3/4" D
Shelves: 10" W x 12-7/8" H x 1" Lip
Shelf: 1/8" Thick
Base: 11-1/8" W x 15-3/4" D
Weight: 12 lbs.



VERTICAL STYLE

MATERIAL: Steel W/Acrylic Products

Product Dimensions:

- Set up:** 10-1/4" W x 62" H x 11" D
Folded: 10-1/4" W x 17-1/2" H x 11" D
Pockets: 9-1/2" W x 14" H x 1-1/2" D
Base: 10-1/2" W x 11" D
Weight: 12 lbs.



DISCONTINUED
PLEASE CALL ONE OF OUR SALES ASSOCIATES FOR OTHER OPTIONS

Part #	Number Of Literature Shelves	Finish
FBH-1	5	Brushed Aluminum

Part #	Number Of Literature Shelves	Finish
FBH-2	4	Matte Silver

MAKE THE MOST OUT OF VALUABLE RETAIL AND SHOWROOM SPACE WITH THESE READY TO USE ARTWORK, ADVERTISEMENT AND LITERATURE HOLDERS.

OFFICE & RETAIL SERIES

- Holds 8-1/2" x 11"
- Perfect for retail countertops or office environments when quick access to info is needed.



WALL MOUNT UNIT

FTF-T291

Material:

Cold Rolled Steel Frame

Features:

- Powder coated black frame with assorted color framed protective sleeves
- Wall mount units can be mounted side for larger display
- Snap on individual hardboard pages

36" x 12-1/2"H



FLOOR STAND UNIT

FTF-T963

Material:

Cold Rolled Steel Frame

Features:

- Powder coated black frame

Size:

15"D x 20"W x 54-1/2"H

Weight: 14 lbs.

DISCONTINUED
PLEASE CALL ONE OF OUR SALES ASSOCIATES FOR OTHER OPTIONS

Make Your Own Flip Frame Display!

**Incorporate a Flip Frame into any display or any space where you need it!
Ideal for displaying samples of Carpeting, Flooring, Tiles ...**

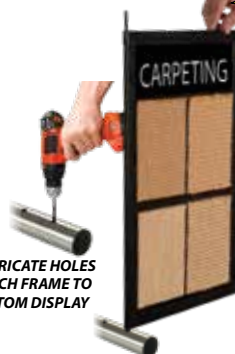
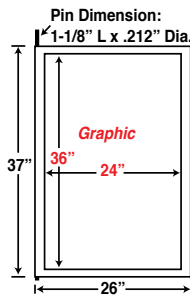

**SIMPLY FABRICATE HOLES
THEN ATTACH FRAME TO
YOUR CUSTOM DISPLAY**

**PERFECT FOR
3-D
SAMPLES**

Material (Frame):

Black Powder Coated Steel

Features:

- Single Panels
- Fits into a 1/4" hole
- 7/32" Maximum frame thickness

Part #	Description
FTF-FRAME	37" H x 26" W x 11/32" Thick Double Sided Flip Through Frame 36-3/16" H x 25-3/16" W Reveal

Use our Foga® System (pgs. D-2~10)
or Tubing (pgs. D-18~24) to help create
your own display.

QUICK, EASY AND EXTREMELY ECONOMICAL!

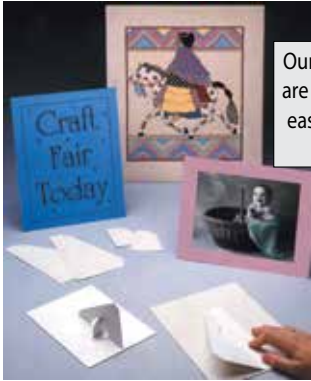

Our self stick easel backs are attractive, sturdy and easy to use. Simply Peel and Stick.

SINGLE WING



Single Wing

Part #	Size	Color
L328-1231B	9"	White
L328-1232B	12"	White
L328-3305B	5"	Black
L328-3307B	7"	Black
L328-3309B	9"	Black

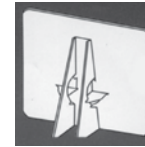

DOUBLE WING

Double Wing

Part #	Size	Color
L328-1236B	7"	White
L328-1239B	15"	White

Universal Counter Cards

FREE STANDING

- Clear plastic sleeve covers
- Heavy White Boards
- Durable construction
- Self standing easel back

REAR VIEW

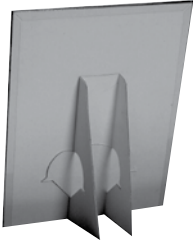

FRONT VIEW



Part #	Size (W x H)
UNI-45	4" x 5"
UNI-57	5" x 7"
UNI-810	8" x 10"
UNI-8511	8.5" x 11"
UNI-912	9" x 12"
UNI-1014	10" x 14"
UNI-1114	11" x 14"
UNI-1117	11" x 17"
UNI-1215	12" x 15"
UNI-12175	12" x 17.5"
UNI-15175	15" x 17.5"
UNI-1620	16" x 20"
UNI-1722	17" x 22"
UNI-1824	18" x 24"

Measurements are width x height; if you need height x width, please inquire.

Brochure Pockets

PEEL & STICK

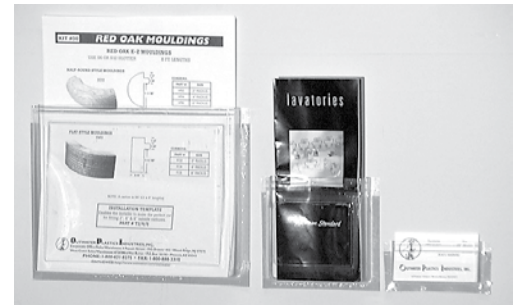

Part #	Dimensions (W x H x Inside Dim.)
POC-1	Business Card Holder
POC-2	3.5" x 4.25" x 1.25"
POC-3	4" x 4.25" x 1.25"
POC-4	4.5" x 4.25" x 1.25"
POC-5	5.5" x 4.25" x 1.25"
POC-6	6.5" x 4.25" x 1.25"
POC-8	8.5" x 8" x 1.25"

OPEN SHORT SIDE CONFIGURATION (OS)

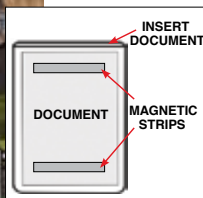

- Clear scan through
- Document Holder/Card Holder comes with two magnetic strips on back, (One strip for 4" x 6")
- Has an open top sleeve with 1/4" drop-down opening on short or long side with beaded edges and round corners.
- Use on shelving racks, equipment, filing cabinets, etc.



BACK OF CVP-1022-OSL

^Comes with only one magnetic strip.

Part #	Dimensions
CVP-312-OS [^]	4" x 6"
CVP-019-OS	5" x 6-3/4"
CVP-249-OS	5-1/2" x 8-7/8"
CVP-022-OS	6" x 9"
CVP-210-OS	9" x 12"

Warehouse Price Tag Job Ticket/Card Holder

OPEN LONG SIDE CONFIGURATION (OSL)

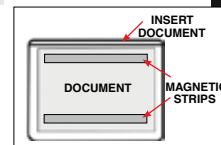

Part #	Dimensions
CVP-1312-OSL [^]	6" x 4"
CVP-1019-OSL	6-3/4" x 5"
CVP-1249-OSL	8-7/8" x 5-1/2"
CVP-1022-OSL	9" x 6"
CVP-1210-OSL	12" x 9"

MATERIAL: GLOSSY SHATTER-PROOF PVC

Removable! Reusable! Affordable! Convenient!

Like a "Post-it"...
Just Peel, Place and Press

Leaves no residue or mess behind and lifts right off to remove



**Perfect for Stores,
Offices, Hotels,
Restaurants, Hospitals,
Schools, Libraries, banks,
Homes, Cars, etc...**

Repositionable Adhesive

2-Sided Window And Wall Sign Holders For Any Smooth Surface

- Stick-It & Sticky Sign works best when applied to clear, dry & smooth surfaces
- Molecular gel needs no tools, holes, screws, wires, accessories to hold firmly
- Instantly protecting & displaying sign in any orientation, on glass from both sides
- Removable - holder/adhesive is reusable
- Adhesive is renewable - rinse off dirt with water & air dry
- Minimize direct sun exposure & temperature above 120°F / 50°C



Stick-It

Part #	Description	Thickness	Graphic Size	Overall Size
PMF-2WH	White border on two short sides ^	.3mm	8-1/2" x 11"	8-1/2" x 13"

^ Other colors available- please inquire

Magnetic

- Instantly protects & displays sign in any orientation on metal surfaces
- Holds up to 10 sheets of 80gm paper
- Removable & reusable
- Easy load style



Part #	Description	Thickness	Graphic Size	Overall Size
TMF-7CL	Crystal clear magnetic backed pocket - easy load style	.55mm	8-1/2" x 11"	8-7/8" x 11-1/2"

Attract attention to your advertisement by using one of these hanging ceiling solutions

WORKS WITH STANDARD 1" CEILING GRID

Grid Clips / Hooks

TWIST LOK CEILING CLIP

- Material: White Styrene
- Easy to remove and relocate
- Includes 6 ft. cord

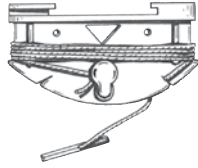

Part #
PTC-3

TWIST-A CEILING LOOPS

- Material: White Styrene
- Easy to remove and relocate
- Large loop accommodates a variety of hanging devices



Part #
7100WH

SNAP ON CEILING GRID CLIP

- Material: Clear ABS
- 3/4" x 3/4" Clip with 3/16" Diameter hole
- Maximum 10 lb. weight capacity

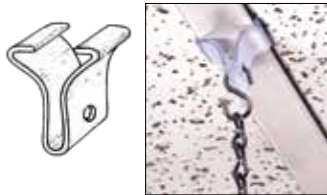

Part #
70-CG

SECURE METAL TWIST CEILING LOOP CLIP

- Material: White Painted Steel
- 1" W x 1-1/2" Long with 3/16" Diameter hole
- Fits most hooks



Part #
CH-7021

STURDY GRILL CEILING HOOKS

- Material: Aluminum
- Hook measures 1-1/4" L x 1" W with 1/4" hook opening
- Use a right & left to create a strong hook
- Use 2 rights or 2 lefts to create a closed-end hook

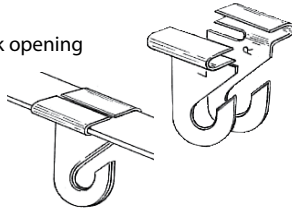

Part #
CH-1R
CH-2L

SNAP-EEZ™ HOOK HOLDER

- Material: White Styrene
- 1-1/4" x 7/8" Grid clip hook holder
- Works with slide hooks to hold and display graphics

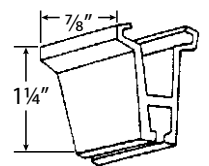

Part #
CH-1000

SNAP-EEZ™ SLIDE HOOKS

- Material: Crystal Clear Lexan™
- Available in 4.5" or 16" Long hooks
- Works with hook holder to hold and display graphics

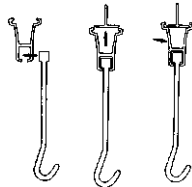

Part #	Length
CH-45	4.5" Long
CH-16	16" Long

CEILING HOOK

- Material: White Styrene
- 1" x 1" Peel & Stick base pad with J-Style hook
- Can be used for vertical and horizontal applications

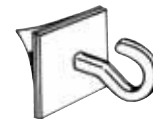

Part #
70-HK

Universal Hooks / Clips

UNIVERSAL PLASTIC CEILING HOOK

- Material: White Styrene
- Barbed on one side and designed to work with standard ceiling grid but also attaches to pipes, cables, hooks, etc.
- Includes 6' Long white cord



Part #
HWC-6

CEILING CLIP

- Material: White Styrene
- 3/4" x 3/4" Peel & Stick base with 3/16" Diameter loop
- Works with most hooks
- Can be used for vertical and horizontal applications



Part #
70-CL

PLASTIC DOUBLE "C" HOOKS

- Material: Clear Polycarbonate
- 3/8" Hook opening on each end
- 5/32" Diameter
- Three Lengths: 6", 12", 18"
- Works with any of our ceiling grid hooks

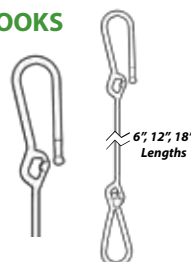

Part #	Length
RBS-6CL	6"
RBS-12CL	12"
RBS-18CL	18"

- SPRING TENSION CLIPS ARE EQUIPPED WITH SOCKET JOINT (S) THAT ROTATE AND TILT IN ALL DIRECTIONS
- MADE OF CLEAR POLYCARBONATE (Except where noted differently)

Roto Clips Up To 3/8" Thick Material

DOUBLE ROTO CLIP SIGN HOLDER

- Clips and holds material up to 3/8" thick.
- Clip is 3/4" W x 1-1/2" H
- Overall clip is 3-3/4" L

Part #
RTC-10



ROTO CLIP SIGN HOLDER

- Clips and holds material up to 3/8" thick.
- Clip is 2" W
- Overall clip is 2-7/8" L

Part #
RTC-20



FLEXIBLE DOUBLE ROTO CLIP

- Clips and holds material up to 3/8" thick.
- Clip is 3/4" W x 1-1/2" H
- Overall clip is 6" L

Part #
RTC-40



ROTO CLIP EXTENDA SIGN HOLDER

- Clips and holds material up to 3/8" thick.
- Clip is 1" W x 5/8" H
- Overall clip is 7-1/2" L

Part #
RTC-30



Roto Clips Up To 1" Thick Material

ROTO CLIP SENIOR SIGN HOLDER

- Sign holds material from .008" to .020" thick.
- Clip measures 2" W x 7/8" H
- Overall clip is 4" L

Part #
RTC-50

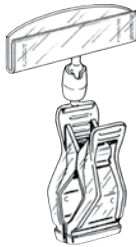

ROTO CLIP EXTENDA SENIOR SIGN HOLDER

- Sign holds material from .008" to .020" thick.
- Sign holder measures 2" W x 7/8" H
- Overall clip is 6" L

Part #
RTC-60



ROTO CLIP JUMBO SIGN HOLDER

- Holds material up to 1/4" thick
- Sign holder measures 3-1/8" W x 4-1/4" H.
- Overall clip is 4-1/4" L

Part #
RTC-70

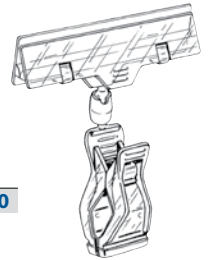

ROTO CLIP W/PRINT PROTECTOR SIGN HOLDER

- Holds material 5-1/2" W x 3-1/2" H and up to 1/32" thick.
- Overall clip is 6-1/2" L



Part #
RTC-35

ROTO CLIP EXTENDA PRINT PROTECTOR SIGN HOLDER

- 5-1/2" W x 3-1/2" H crystal clear sign holder holds material up to 4" W x 2" H.
- Overall clip is 8-1/2" L

Part #
RTC-38



ROTO CLIP MULTI-CHANNEL SIGNBOARD

- Black plastic sign board holds one sign 4-1/16" H x 4" W or two signs 4" W x 2" H.
- Overall clip is 6" L

Part #
RTC-39



ROTO CLIP EXTENDA JUMBO SIGN HOLDER

- Super strong 3-1/8" W sign holder holds material up to 1/4" thick.
- Overall clip is 6-1/2" L

Part #
RTC-80

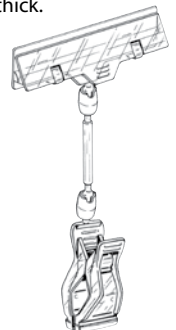

Surface Mount Roto Clips

- SPRING TENSION CLIPS ARE EQUIPPED WITH SOCKET JOINT (S) THAT ROTATE AND TILT IN ALL DIRECTIONS
- MADE OF CLEAR POLYCARBONATE (Except where noted differently)

ROTO CLIP WITH SUCTION CUP

- Suction cup base with wobble extenda arm.
- Clips and holds material up to 3/8" thick.
- Clip is 3/4" W x 1-1/2" H
- Overall clip is 7" L

Part #
RTC-90



ROTO CLIP SIGN HOLDER WITH PEEL AND STICK BASE

- 3-1/2" Diameter peel and stick base w/rotate and tilt capability.
- 3-1/2"W holds material up to 1/4" thick.
- Overall clip is 7" L

Part #
RTC-75



ROTO CLIP SPIRAL WIRE WITH MAGNET

- Magnetic base with bendable white PVC wire clad completely bends and adheres to all steel surfaces.
- Clip holds material up to 1/32" thick.
- Overall clip is 12" L

Part #
RTC-26



Pear Clips

For Banner Hanging or Sample Swatches

STANDARD

Material: Zinc Plated Steel



Part #
PC-1

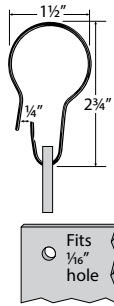

THREADED LOCKING

Material: Chrome Plated Steel



Part #
GST-PEAR

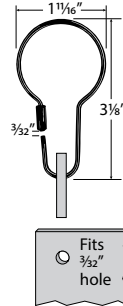

Metal Squeeze Clip

- Material: Steel
- 1-5/8" W x 3-3/8" L
- Easy squeeze clip for quick installation

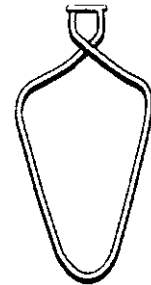

Part #
T250

Metal Sign Clip

- Material: Zinc Plated Steel
- Fasten signage to clip
- Clip is 1"W x 1-3/4"H overall
- Fits up to .375" dia. wire
- 1/4" hole - use RA-4375 rivet (see page B-16)

Part #
SGN-CLP

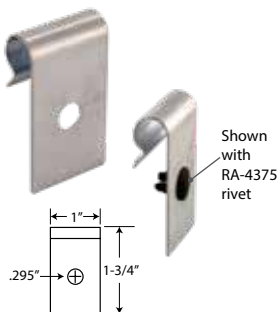

S-Hooks

- Material: Bright Plated Steel
- These hooks not only work with the above ceiling applications, but with wire, shelving, hooks, etc.

Part # Size
T230 1" x .080 Dia.
T235 1-3/4" x .135 Dia.

