



Family Owned & Operated

OUTWATER
INDUSTRIES

EST. 1972

New Jersey • Pennsylvania • Arizona



EXTRUSIONS

Ready to Ship

Over
10 Million
Feet In Stock



1-800-631-8375

www.outwater.com

TERMS AND CONDITIONS

"Vendor":

Outwater Plastics Industries, Inc. & Architectural Products by Outwater, LLC

PRICES:

All prices are subject to change without notice. No deduction will be allowed at settlement. Minimum order is \$25.00 (Merchandise only). Orders less than this minimum will be billed as \$25.00 plus shipping charges and tax, if applicable.

NOTE:

Orders are accepted with the understanding that they will be billed at the price in effect on the day of shipment.

PAYMENT TERMS:

N30

To establish N30 terms, we must be supplied with your company's Dun & Bradstreet number (DUNS Number). Concerns not rated favorably with Dun & Bradstreet, not rated at all with Dun & Bradstreet or inactive accounts, are required to furnish, on company letterhead, four (4) trade references, the name of their bank and account number, their Federal I.D. number or CRA-issued business number, and the date and state/province their business was incorporated.

Please note: If supplying trade references, please allow 2-3 weeks for processing.

Credit Card

We accept major credit cards (Visa, MasterCard, American Express and Discover.) Please note: When authorizing us to charge your card in an amount over \$500.00, we require a signed credit card authorization form, which we will fax or email to you for your signature. Order processing will not begin until this authorization is returned to us.

C.O.D.

C.O.D. orders are no longer accepted.

Prepayment

Customers not wishing to use a credit card or set up N30 terms, may prepay orders. Please speak with your sales representative when placing your order. We accept company checks and certified / bank checks. Order processing will not begin until we receive payment. Non-certified checks (company or personal) may take an additional five business days after receipt before order processing will begin.

Other Terms

Large orders, Custom or Special Order items may require certified funds and/or a deposit, regardless of existing credit terms. If applicable, this will be discussed at time of order. If a deposit is required, order processing will not begin until deposit is received by us. Should deposit be sent in the form of a non-certified check, it may take an additional five business days after receipt before order processing will begin.

WARRANTY:

All merchandise is produced to standard and commercial tolerances. Vendor warrants product to be free from defects in workmanship and material. When Vendor has determined that a product is defective, it will be replaced. At Vendor's discretion, a credit may be offered instead of replacement. Vendor liability is limited to the cost of the defective product. No other warranty is expressed or implied.

LIABILITY:

The customer shall test and verify the suitability of the product for intended use. No warranty for intended use is made. The customer assumes all risk and liability. Vendor's only obligation is replacement or credit for product proven defective. Vendor shall not be liable for any loss or damage from the use or inability to use the product.

TECHNICAL ADVICE:

Any technical advice furnished or recommended by Vendor or any representative of Vendor concerning any use or application of any product is believed to be reliable but the company makes no warranty of results obtained. The customer shall test for and verify suitability for intended use.

FREE SAMPLE POLICY:

Reasonable sample quantities are available at no charge for many of the products within this catalog; to test their suitability for your intended use or application. Most samples are shipped free of charge via standard U.S. mail or UPS ground. Other shipping options are available, at customer's expense. Please discuss with our sales representatives.

MERCHANDISE RETURN POLICY:

Merchandise may not be returned for credit without prior authorization from our Customer Service department. Please have your order number available when contacting us.

- You may return most items purchased for a partial refund within 30 days of purchase. A restocking fee will apply and shipping charges will not be refunded. Restocking fees as follows:
 - 20% restocking fee applies to most stock items. Some dropship items will be subject to a higher restocking fee. Where applicable, fees are stated within our catalog.
 - 40% restocking fee applies on items that have been cut for shipping purposes. Custom or Special order items may not be returned.
- Refund will only be issued in the original form of payment.
- Customer is responsible for the shipping cost of items returned. Be mindful of packaging as any damage during return shipment is the responsibility of the customer.
- Returned material must be received in original condition.
- Any products cut, altered, modified or installed by the customer may not be returned.
- We reserve the right to refuse unauthorized returns. Unauthorized returns will be returned to the customer at their expense.

DAMAGE/LOSS:

- Upon receiving your shipment, please inspect the packages carefully for signs of damage. Check contents for damaged or missing items.
- Damage and/or loss claims must be reported within 48 hours from time of receipt!
- We utilize small parcel carriers [UPS and Federal Express] and many LTL freight carriers [such as YRC, New Penn and UPS Freight] when shipping our products. Specific instructions will vary depending on the carrier.
- If Damage/Loss is suspected, please do the following:
 - Inspect your shipment as soon as it arrives.
 - If your merchandise has arrived via LTL freight carrier, all damages/loss must be noted on the delivery receipt at time of delivery. Please take digital photographs and email to: customerservice@outwaterplastics.com.
 - Please keep all merchandise and packing material for possible inspection by the carrier.
 - Contact our Customer Service Department immediately! It is best to get in touch with us right away. Be advised that claims made after 48 hours of receipt will not be honored.

DEFECTIVE MERCHANDISE POLICY:

Every item that we sell meets our highest standards for quality and performance. If a defect in merchandise is suspected, please proceed as follows:

- Inspect merchandise for quality before altered or installed.
- Upon the finding of parts which may be defective, contact our Customer Service Department immediately! We will request digital images, a sample of the material, or a combination of both material and images to be sent to our Customer Service Department for evaluation.
- Upon review of the samples/images we will determine if replacement or refund is appropriate. Return of the defective merchandise will also be determined at this time and if deemed necessary an RMA (Return Merchandise Authorization) will be issued.
- The responsibility of Outwater Plastics and Architectural Products ends here. Any loss incurred for labor, transportation or any other expenses are not covered.

PICK UP ORDERS:

Orders placed for pick up must be picked up within 2 weeks from the date placed, or the date material becomes available. Orders not picked up within 2 weeks will be cancelled. To secure material for a longer time period; arrangements may be made for non-refundable prepayment and pick up by a specified date.

SHIPPING TERMS:

Shipments are F.O.B. shipping point.

INTERNATIONAL SHIPPING TERMS & CONDITIONS:

Items for shipment to countries outside of the U.S. may be subject to taxes, customs duties and fees levied by the destination country ("Import Fees"). The recipient of the shipment is the importer of record in the destination country and is responsible for all Import Fees. To obtain details regarding the Actual Import Fees, or to obtain documentation or receipts in connection with customs clearance, you may contact the Designated Carrier specified in your shipment confirmation.

*** WE RESERVE THE RIGHT TO SUBSTITUTE OR "EQUAL" ***



3 LOCATIONS
(800) 631-8375

EAST
24 River Road • Bogota, NJ 07603
390 N Pennsylvania Avenue • Wilkes Barre, PA 18702

WEST
4720 West Van Buren Street • Phoenix, AZ 85043

TABLE OF CONTENTS

Acrylic Fabricating Products.....	75-77
Aluminum Framing System.....	112-120
Angle Moulding.....	34-37
Binning Strips & Components.....	73
Bumper Moulding.....	6-7, 9
Cap & Divider Moulding.....	26-30
Closet Rods, Systems & Hardware.....	102-107
Corner Moulding.....	32-33
Cove Moulding.....	36
Double Stick Foam Tape.....	17
Drawer Pulls.....	80-82
Edgebanding & Trims.....	12-14
Extruded Clear Acrylic Tubes & Rods.....	74
Face Nosing.....	31
Filler Moulding.....	8
Fixture & Wall Bumper.....	91-94
FOGA® System.....	108-111
Foot Rail Kits.....	83
Front Loading Aluminum Frames.....	54-55
Guard Moulding.....	31
Hinges.....	77-79
Hook & Loop Velcro Fastening Tapes.....	17
Impact Protection System.....	95-101
Joiner Moulding.....	30
Lighting.....	121-135
Magnetic Strips, Sheets & Clamps.....	16
Panel/Glass Retaining Buttons & Clips.....	90
Picture & Art Hanging Systems.....	58-67
Price Tag Moulding.....	42-43
Rounded Trim.....	31
Shelf Guard.....	68
Showcase Moulding.....	31
Sign Holders.....	49-51
Sign/Banner Holders.....	52-53, 56
Slatwall Panels & Hardware.....	70-71, 75
Sliding Door Track.....	39-41
Standoffs.....	57
Tee Moulding.....	4-11
Ticket & Label Holders.....	44-48
Tools.....	14-15
Track Systems For Tambour Doors.....	38
U-Channel Moulding.....	18-25
Vents.....	72
Wire Management.....	84-89
Z & W Bar.....	75
Z-Panel Hangers & Clips.....	69



Aluminum Framing System pg. 112



Aluminum LED Drywall Profiles pg. 126



Corner Guards pg. 100



Flexible U-Channel Moulding pg. 23



LED Aluminum Channels pg. 121



Off-Set Rippled Tee Moulding pg. 8



Sliding Door Track pg. 39



Wire Management pg. 84



FLEXIBLE POLYETHYLENE TEE MOULDING

Lengths: 250 Ft. Coils *Sample Chains Available - Please Inquire*

Use S1 or S7 Slotter *unless otherwise noted*

Stock Colors Available

*770 Almond	*742 Angola Brown	*288 Beige	*260 Black	*131 Blue	*386 Bronze ▲	*113 Green	*632 Opti Gray ◆
*175 Putty Gray	*324 Red	*363 Silver	*243 Storm Gray ◆	*315 Brown	*248 Chamois Yellow ◆	*125 Dove Gray	*236 Fresca Green ◆
*212 Folkstone ◆	*253 Gold ▲	*579 Tan	*709 Tan	*614 Toy Blue ◆	*601 White	*895 Yellow	

◆ Available in 5/8", 3/4" & 13/16" widths only
 ▲ 5000 ft. minimum apply

Woodgrains Available

*817P American Nat. Maple	*866P Natural Oak
*809P Boston Cherry	*747P Teak
*423 Oak	

Cherry is available in 3/4", 13/16" & 1-1/4" only

**NOTE: We can supply other colors
 - Minimums apply - please inquire**

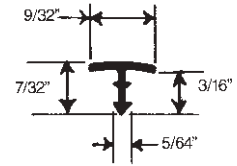

Fits 9/32"

Uses
S065
Slotter

Part #

105-656-260	Black
105-656-315	Brown
105-656-601	White

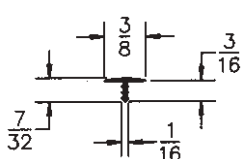

Fits 3/8"

Uses
S065
Slotter

Part #

105-318-*	Color
-----------	-------

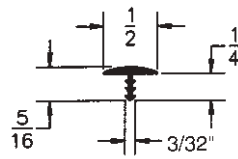

Fits 1/2"

Uses
S065
Slotter

Part #

105-667-*	BK & WH Color W/G
-----------	-------------------------

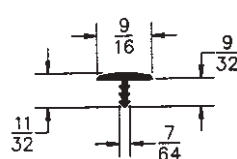

Fits 9/16"

Part #

105-668-*	Color W/G
-----------	--------------

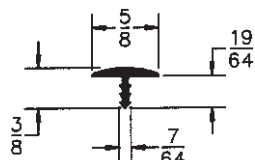

Fits 5/8"

Part #

105-662-*	BK & WH Color W/G
-----------	-------------------------

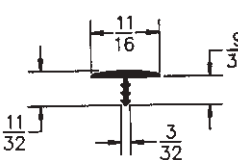

Fits 11/16"

Uses
S065
Slotter

Part #

105-677-*	BK & WH Color W/G
-----------	-------------------------

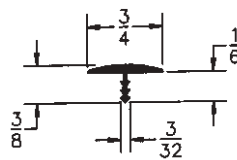

Fits 3/4"

Uses
S065
Slotter

Part #

105-679-*	BK & WH Color W/G
-----------	-------------------------

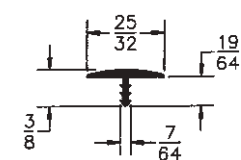

Fits 25/32"

Part #

105-2532-*	Color W/G
------------	--------------

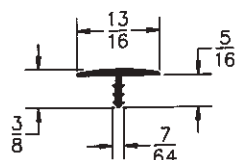

Fits 13/16"

Part #

105-658-*	BK & WH Color ◆ W/G
-----------	---------------------------

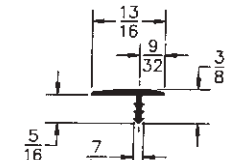

Fits 13/16"

Offset

Part #

105-659-*	Color
-----------	-------

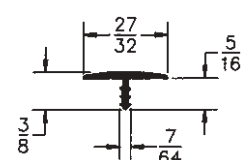

Fits 27/32"

Part #

105-2732-*	Color W/G
------------	--------------

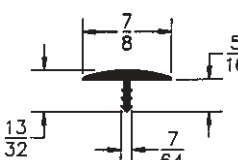

Fits 7/8"

Part #

105-650-*	Color W/G
-----------	--------------

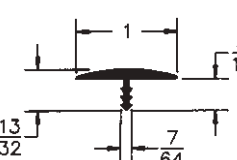

Fits 1"

Part #

105-651-*	Color W/G
-----------	--------------

SEE PAGE 15 FOR TEE MOULDING TOOLS & BLADES



FLEXIBLE POLYETHYLENE TEE MOULDING

Lengths: 250 Ft. Coils *Sample Chains Available - Please Inquire*

Use S1 or S7 Slotter *unless otherwise noted*

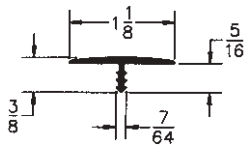
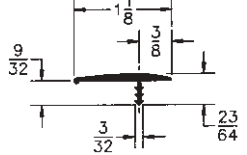
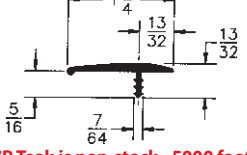
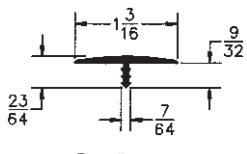
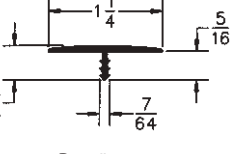
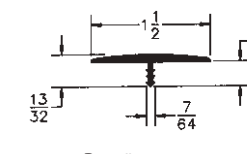
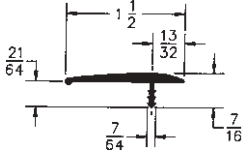
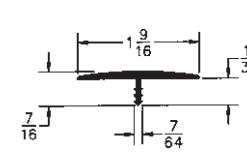
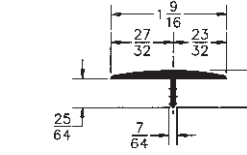
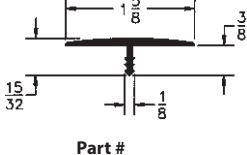
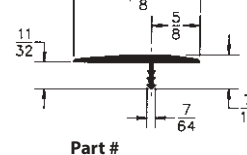
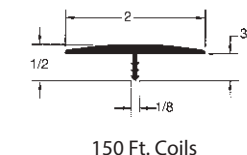
<p>Fits 1-1/8"</p>  <p>Part # 105-563-* Color W/G</p>	<p>Fits 1-1/8" Offset</p>  <p>Part # 105-564-* Color</p>	<p>Fits 1-1/4" Offset w/Bead</p>  <p>Part # 105-544-* Color W/G</p> <p><i>(#747P Teak is non-stock - 5000 foot minimum)</i></p>
<p>Fits 1-3/16"</p>  <p>Part # 105-1316-* Color</p>	<p>Fits 1-1/4"</p>  <p>Part # 105-543-* Color W/G</p>	<p>Fits 1-1/2"</p>  <p>Part # 105-672-* Color W/G</p>
<p>Fits 1-1/2" Offset</p>  <p>Part # 105-673-* Color W/G</p>	<p>Fits 1-9/16"</p>  <p>Part # 105-1916-260 Black 105-1916-315 Brown 105-1916-601 White</p>	<p>Fits 1-9/16" Offset</p>  <p>Part # 105-1917-260 Black 105-1917-315 Brown 105-1917-601 White</p>
<p>Fits 1-5/8"</p>  <p>Part # 105-1058-260 Black 105-1058-315 Brown 105-1058-601 White</p>	<p>Fits 1-5/8" Offset</p>  <p>Part # 105-1059-260 Black 105-1059-315 Brown 105-1059-601 White</p>	<p>Fits 2" Uses S2 or S8 Slotter</p>  <p>150 Ft. Coils Part # 105-2000-260 Black 105-2000-601 White</p>

FLEXIBLE EMBOSSED LEATHERETTE POLYETHYLENE TEE MOULDING

Lengths: 250 Ft. Coils • Use S1 or S7 Slotter

Colors Available

243 Storm Gray | **260** Black

unless otherwise noted

NOTE: We can supply other colors, minimums may apply. Please inquire

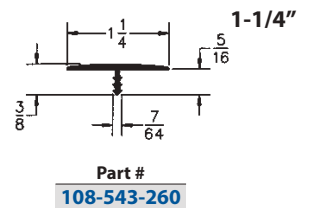
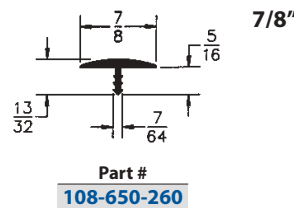
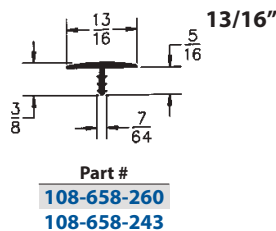
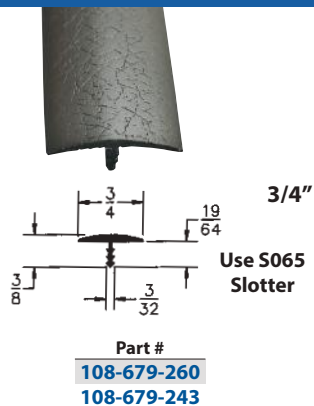

SEE PAGE 15 FOR TEE MOULDING TOOLS & BLADES

GLOSSY BUMPER MOULDING

Lengths: 50 Ft. Coils
 Material: PVC • Use S4 or S10 Slotter • High Profile Design • Minimum 5" Radius

Colors Available

*BK - Black *DG - Dove Gray *AL - Almond

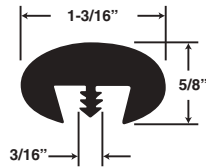

Fits 11/16" & 3/4"

Part #
PROPOR3019DRT-*



Material: PVC/Dual Durometer • Use S4 or S10 Slotter • Black
 High Profile Design • Can Make 4"-5" Radius

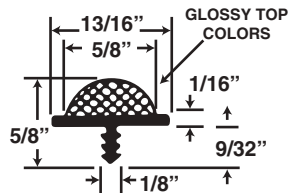

Part #
302-812-BK/BK



250 Ft. Coil
 S3/S9 Slotter

Lengths: 50 Ft. Coils
 Material: PVC • Use S4 or S10 Slotter

Colors Available



Part #
303-1032-BK
303-1032-*

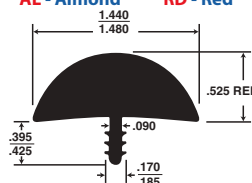
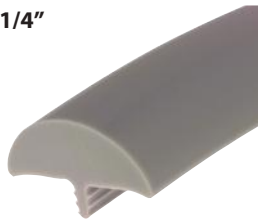

Part #
303-1038-BK
303-1038-*



GLOSSY SPECIALTY ANGLE BUMPER MOULDING

Lengths: 125 Ft. Coils
 Material: Vinyl PVC • Use S4 or S10 Slotter • Black

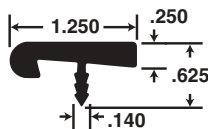

Part #
310-1000-BK

For 7/8" Board



DOUBLE BLACK SPLINE

Lengths: 6 Ft.
 Material: Styrene
 Use S4 or S10 Slotter
 Use when attaching mouldings to routed surfaces

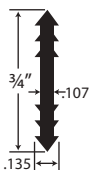

Part #
R106-684-BK



LIPPED TEE MOULDING

Lengths: 250 Ft. Coils
 Material: Polyethylene

Colors Available

260 - Black 601 - White

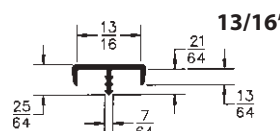

Part #
521-812-260
521-812-601

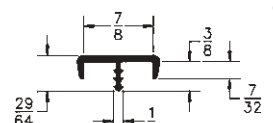

Part #
521-875-260
521-875-601

STANDARD BUMPER MOULDING



Lengths: 250 Ft. Coils - UPS Shippable/Self Healing
Material: PVC

Colors Available

*WH - White *BK - Black *BR - Brown *DG - Dove Gray
*AL - Almond *RD - Red *SIL - Silver *SG - Slate Gray
unless otherwise noted

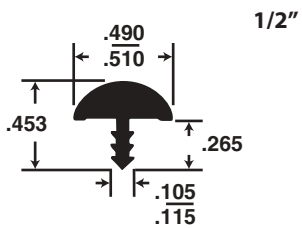

S1 or S7 Slotter

Part #

303-576-BK
303-576-WH

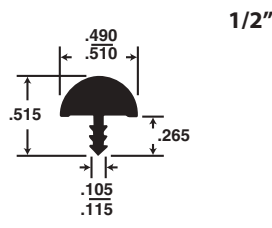

S1 or S7 Slotter

Part #

303-575-BK
303-575-*

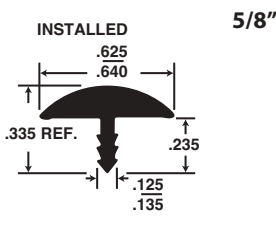

S2 or S8 Slotter

Part #

303-625-BK
303-625-*

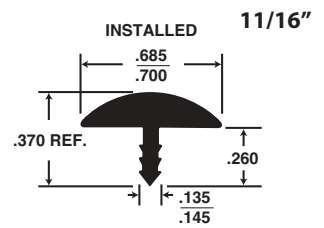

S2 or S8 Slotter

Part #

303-687-BK
303-687-*

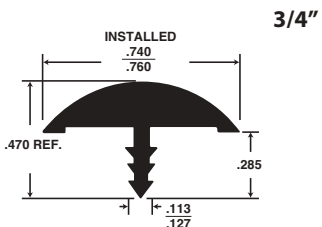

S2 or S8 Slotter

Part #

303-750-BK
303-750-*

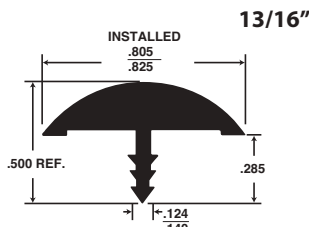

S3 or S9 Slotter

Part #

303-812-BK
303-812-*
303-812-SIL

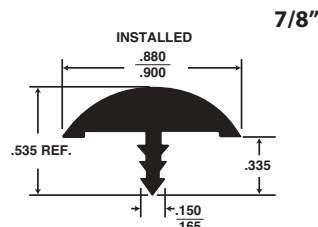

S4 or S10 Slotter

Part #

303-875-BK
303-875-*

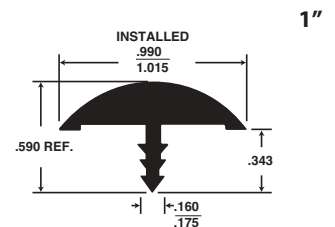

S4 or S10 Slotter

Part #

303-1000-BK
303-1000-*
303-1000-SIL
Slate Gray available

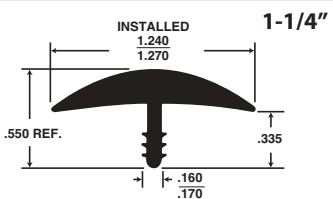

S4 or S10 Slotter

Part #

303-1250-BK
303-1250-*

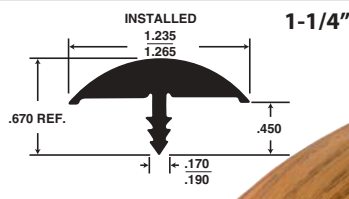

WOOD GRAIN

S4 or S10 Slotter-100 Ft. Coils

Part #

303-1250-OK

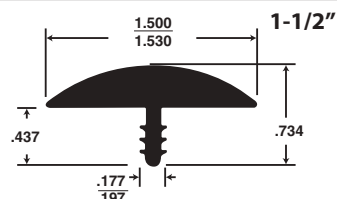

S4 or S10 Slotter-100 Ft. Coils

Part #

303-1500-BK
303-1500-*

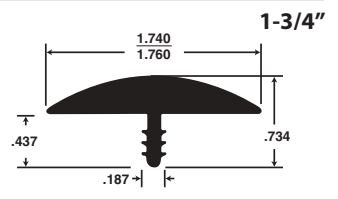

S4 or S10 Slotter-100 Ft. Coils

Part #

303-1750-BK
303-1750-*



SEE PAGE 15 FOR TEE MOULDING TOOLS & BLADES

STRAIGHT EDGE METALLIC TEE MOULDING

Lengths: 12 Ft.
 Material: ABS/Mylar - Rigid/Protective Cover • Use S1 or S7 Slotter
 Absolutely Wave and Distortion Free • Available From Stock

Finishes Available

*POL/C - Polished Chrome

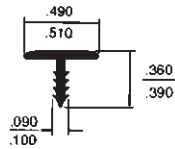

1/2"

Part #
2025-POL/C

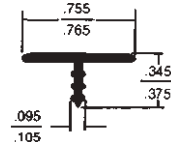

3/4"

Part #
1928-POL/C

2-TONE DESIGNER TEE MOULDING

Lengths: 250 Ft. Coils • Use S2 or S8 Slotter

unless otherwise noted

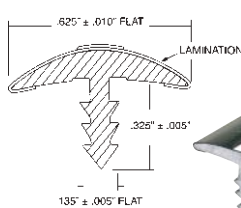

5/8"

PVC Film
 Brite Chrome W/Black Shoulders

Part #
9677S-B/C

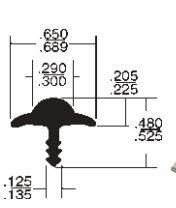

Nominal 11/16"

PVC Film
 Brass Edges W/Black Center

Part #
2308-BK

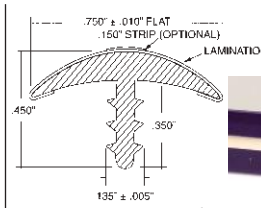

3/4"

PVC/Film
 Brite Brass W/Black Shoulders=(B/B)
 Brite Chrome W/Black Shoulders=(B/C)

Part #
96782S-B/B
96782S-B/C

OFFSET BARB RIPPLED TEE MOULDING

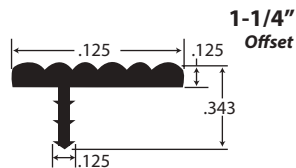

1-1/4"

Offset

25 Ft. Coils - PVC Silver
 The Look Of Satin Aluminum

Part #
2350-SIL

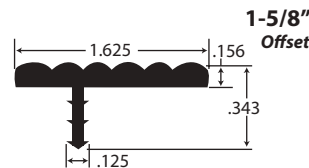

1-5/8"

Offset

150 Ft. Coils - PVC Silver
 The Look Of Satin Aluminum

Part #
2355-SIL

ALUMINUM FILLERS

Lengths: 12 Ft.

Finishes Available

*M - Mill - Dull Finish: As Extruded - May or May Not Have "Scratches"/Die Lines

*P - Polished - Shiny/Mirror Finish

*S - Satin/Clear Anodized - Dull, Matte Finish

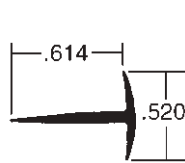

1/2"

Part #
ALU411-*

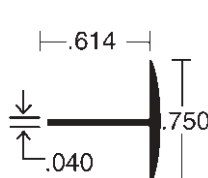

3/4"

Part #
ALU0365-P

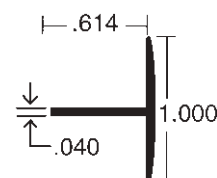

1"

Part #
ALU0395-P

FLAT FACE BUMPER MOULDING



Lengths: 250 Ft. Coils
Material: PVC

Colors Available

*WH - White *BK - Black *DG - Dove Gray *BR - Brown *AL - Almond

Custom Colors Available - Please Inquire

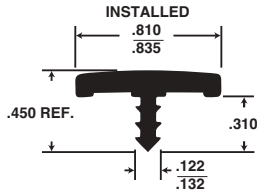

13/16"

S3 or S9 Slotter

Part #

304-812-BK
304-812.*

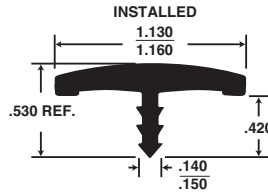

1-1/8"

S4 or S10 Slotter

Part #

304-1125-BK
304-1125.*

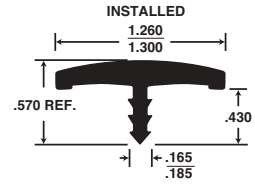

1-1/4"

S4 or S10 Slotter

Part #

304-1250-BK
304-1250.*

BLACK WATERFALL BUMPER MOULDING



Contoured Edge

Material: Matte PVC • Use S4 or S10 Slotter
6 Millimeter • Color Thru and Thru

Unique design allows you to trim from the bottom while keeping the contoured edge on top

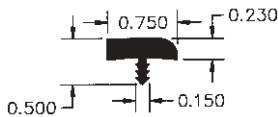

3/4"

250 Ft. Coils

Part #

110-075-BK

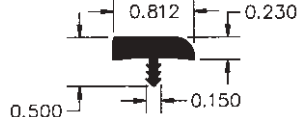

13/16"

250 Ft. Coils

Part #

110-812-BK

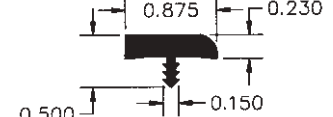

7/8"

250 Ft. Coils

Part #

110-875-BK

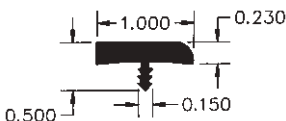

1"

100 Ft. Coils

Part #

110-100-BK

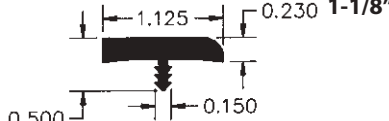

1-1/8"

100 Ft. Coils

Part #

110-112-BK

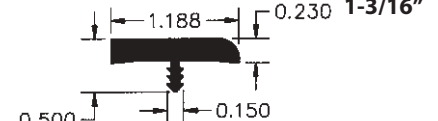

1-3/16"

100 Ft. Coils

Part #

110-118-BK

BLACK POLY BUMPER MOULDING



Lengths: 100 Ft. Coils • Material: Polyethylene • Use S3 or S9 Slotter

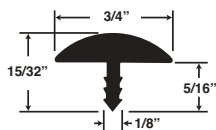

3/4"

Part #

307-750-BK

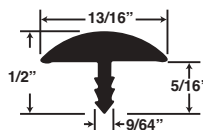

13/16"

Part #

307-812-BK

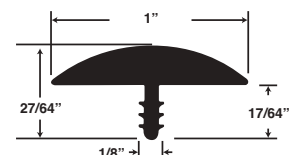

1"

Part #

307-1000-BK

FLEXIBLE METALLIC TEE MOULDING

Streamlining Wrap Around Metallic Film

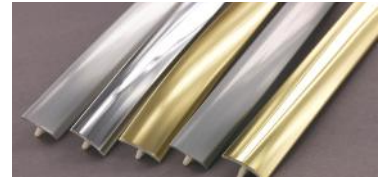

Lengths: 250 Ft. Coils
Material: PVC Core • Use S1 or S7 Slotter

Finishes Available

*POL/B - Polished Brass *POL/C - Polished Chrome
*BRU/B - Brushed Brass *BRU/C - Brushed Chrome

unless otherwise noted

This flexible TEE MOULDING is manufactured from a soft, pliable vinyl which conforms to the contours of any product design with the highly flexible, bright finish surface and underside, it easily turns tight inside and outside corner radius.

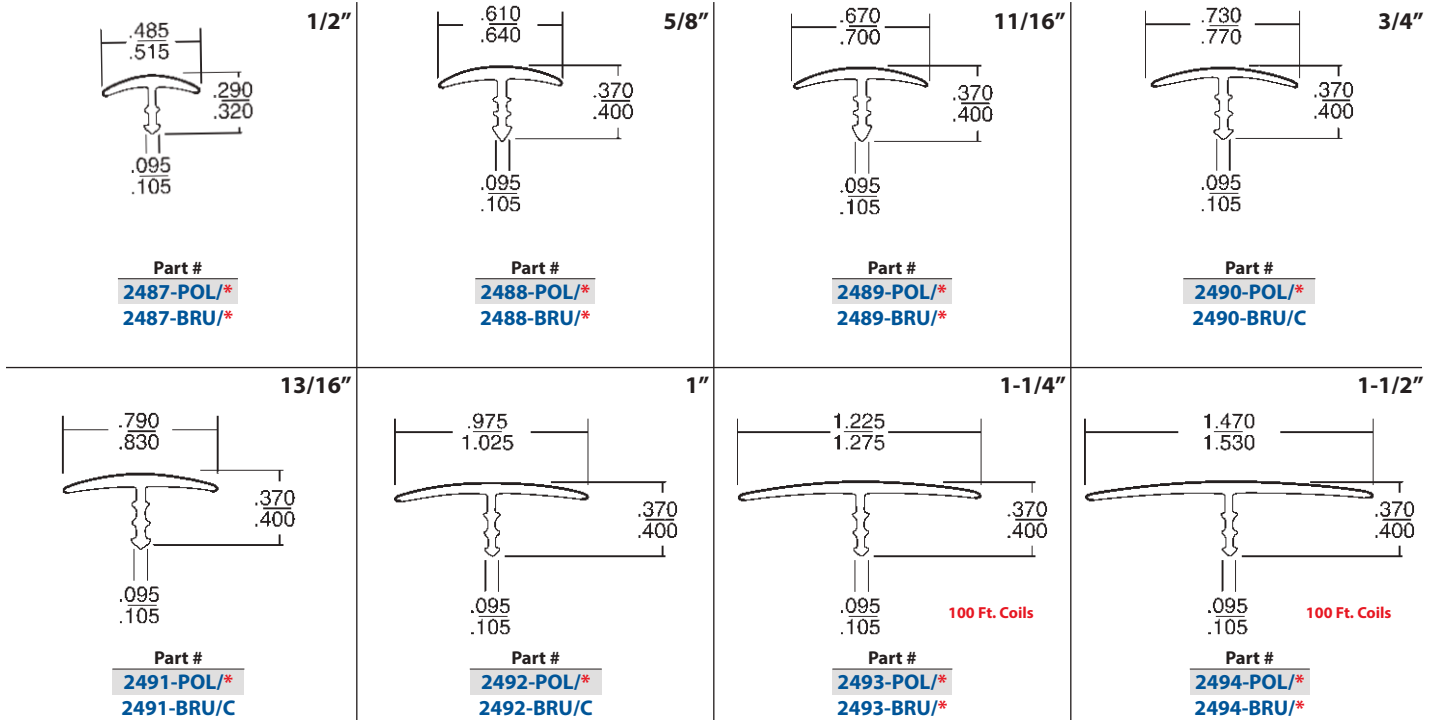

CARBIDE TIPPED TEE MOULDING BLADES

2 Wing Blade



Part#	No. Of Wings	Slot Thickness
S055	2	.055"
S065	2	.065"
S1	2	.075"
S2	2	.080"
S3	2	3/32"
S4	2	1/8"
S5	2	3/16"
S6	2	1/4"

4 Wing Blade



Part#	No. Of Wings	Slot Thickness
S7	4	.075"
S8	4	.080"
S9	4	3/32"
S10	4	1/8"
S11	4	3/16"
S12	4	1/4"
S13	4	.065"

Arbor A1/B1

A1 Arbor w/Locknut & B1 Bearing w/Washer



5/16" Bore
1/4" Shank
1/2" Cut

Complete Set

2 Wing w/Arbor & Bearing

4 Wing w/Arbor & Bearing



Part#	No. Of Wings	Slot Thickness
SJ-055	2	.055"
SJ-065	2	.065"
SJ-1	2	.075"
SJ-2	2	.080"
SJ-3	2	3/32"
SJ-4	2	1/8"
SJ-5	2	3/16"
SJ-6	2	1/4"

Part#	No. Of Wings	Slot Thickness
SJ-7	4	.075"
SJ-8	4	.080"
SJ-9	4	3/32"
SJ-10	4	1/8"
SJ-11	4	3/16"
SJ-12	4	1/4"
SJ-13	4	.065"

"NO NOTCH" REAL ALUMINUM TEE MOULDING

Lengths: 12 Ft. • Rippled Face • 4" Minimum Radius

Finishes Available

*M - Mill - Dull Finish: As Extruded - May or May Not Have "Scratches"/Die Lines

*S - Satin/Clear Anodized - Dull, Matte Finish

New technology allows you to shape and form a variety of designs

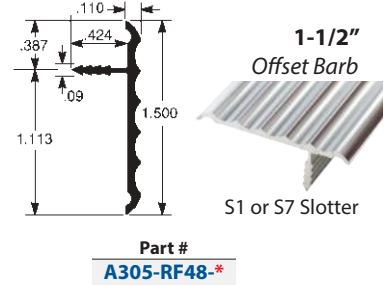
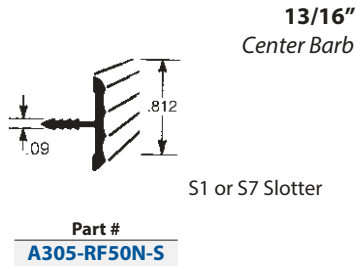

REAL ALUMINUM TEE MOULDING

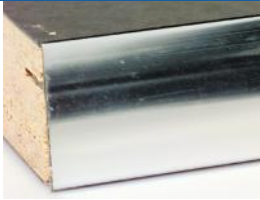

Lengths: 12 Ft.

Finishes Available

*M - Mill - Dull Finish: As Extruded - May or May Not Have "Scratches"/Die Lines

*P - Polished - Shiny/Mirror Finish

*S - Satin/Clear Anodized - Dull, Matte Finish

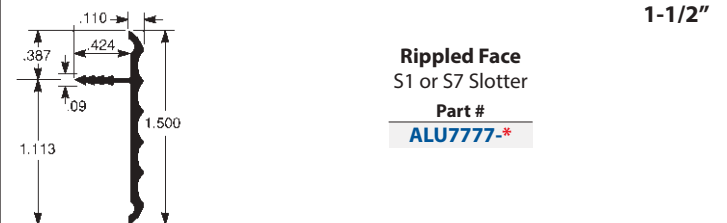
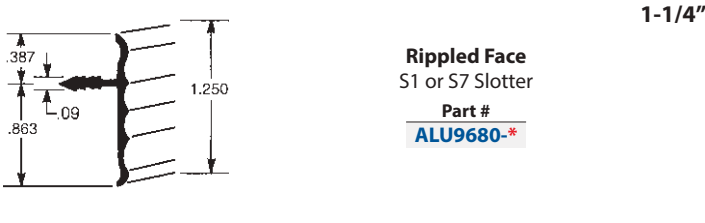
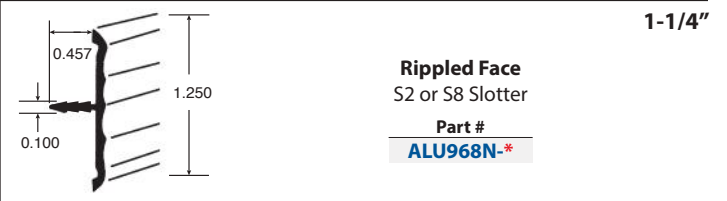
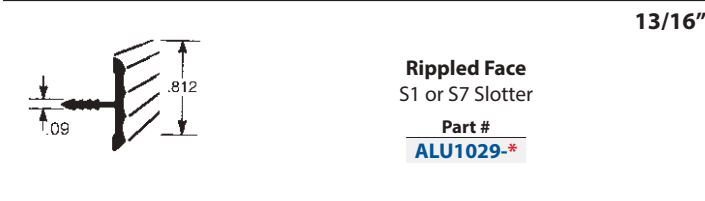
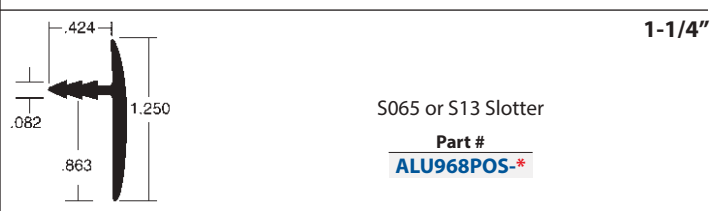
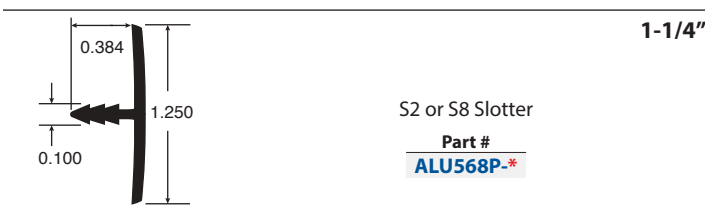
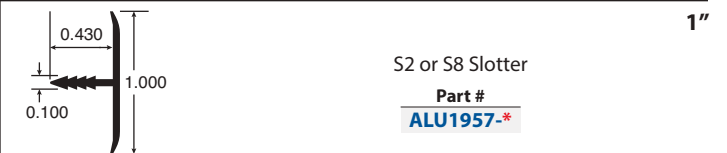
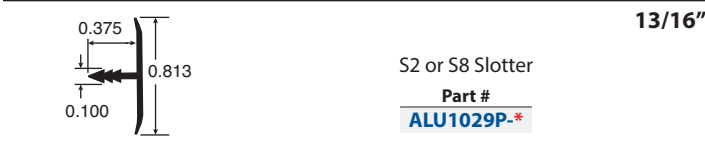
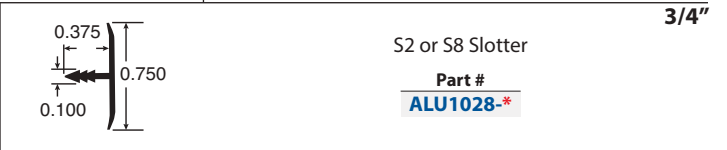
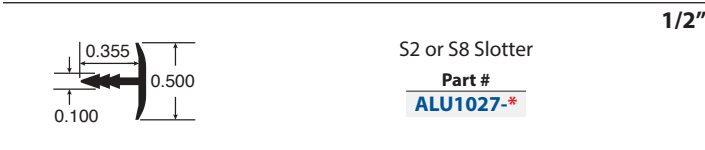
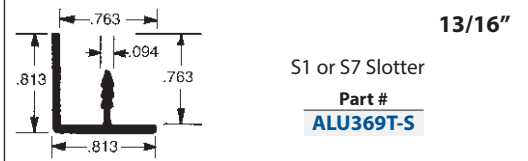

PEEL & STICK EDGEBANDING

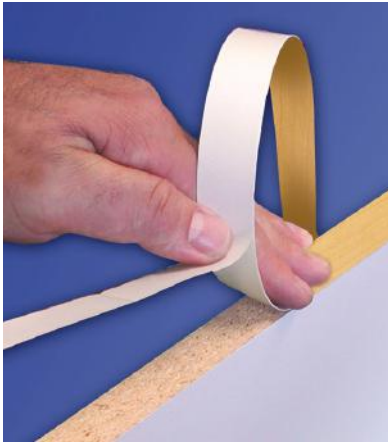

- Just peel and stick it
- Bond increases in strength with time
- 50' & 250' rolls
- 600' rolls available (PVC Only), Please Inquire
- .020 thickness
- Custom colors and sizes up to 5" available for 1 roll minimum, please inquire

Part #	Description	Size
FESP-34-*	PVC Solid	3/4"
FEWP-34-*	PVC Wood Grain	
FESW-34-*	Unfinished Wood	
FEPW-34-*	Finished Wood	
FEME-34-*	Metallic PVC	15/16"
FESP-1516-*	PVC Solid	
FEWP-1516-*	PVC Wood Grain	
FESW-1516-*	Unfinished Wood	
FEPW-1516-*	Finished Wood	
FEME-1516-*	Metallic PVC	

PVC (Solids, Woodgrains and Metallics)

*WH White	*RN Renaissance Oak	(*CM) Clear Maple	*BR Brushed Brass	*GC Golden Cherry
*AW Antique White	(*MD) Medium Oak	*AM American Maple	*PBR Polished Brass	*DC Dark Cherry
*AL Almond	(*LO) Light Oak	*NC Natural Cherry	*BCHR Brushed Chrome	*HT Heritage Cherry
*BK Black	(*HM) Hardrock Maple	*PW Presidential Walnut	*PCHR Polished Chrome	*AC Autumn Cherry
*DG Fog Gray	(*MM) Manitoba Maple	*IW Imperial Walnut	*SC Select Cherry	*FC Fuji Cherry
*LG Folkstone Gray	(*LM) Light Maple	*MW Mahogany on Walnut	*MC Medium Cherry	*RM Red Mahogany
*NO Natural Oak	*BE Beech	*KP Knotty Pine	*BC Bourbon Cherry	*DM Dark Red Mahogany
*GO Golden Oak				

Unfinished (Real Wood)

*RO Red Oak	(*MP) Maple	*WA Walnut	*WO White Oak	(*CH) Cherry
-----------------------	-----------------------	----------------------	-------------------------	------------------------

Pre-finished (Real Wood)

*FRO Red Oak	*FMP Maple	*FB Birch	*FWO White Oak	*FCH Cherry	*FWA Walnut
------------------------	----------------------	---------------------	--------------------------	-----------------------	-----------------------

For more Unfinished and Pre-finished colors, please inquire.

POLYESTER EDGEBANDING

PEEL & STICK POLYESTER EDGE BANDING IN COLOR

Lengths: 250 Ft. Coils

- Works With Most Foam Board Edges

Stocked Colors Available

***WH** - White ***BK** - Black



Part #	Width
PE-500*	1/2"
PE-625*	5/8"
PE-750*	3/4"
PE-812*	13/16"
PE-1000*	1"
PE-1500*	1-1/2"

PRE-GLUED IRON ON TAPES

Colors Available

*WH - Frost White *BK - Black

Part #	Size
IOC625-BK	5/8"
IOC750-*	3/4"
IOC812-*	13/16"
IOC875-*	7/8"
IOC100-BK	1"
IOC1125-BK	1-1/8"
IOC1250-BK	1-1/4"
IOC150-BK	1-1/2"



Real Wood Veneer Fleece Edge Available

*RD - Red Oak *WO - White Oak *WB - White Birch *CH - Cherry

Part #	Size
IOV750-*	3/4"
IOV812-*	13/16"
IOV875-WB	7/8"
IOV100-RO	1"
IOV1250-*	1-1/4"

METAL LIKE TRIMS

Edgebanding and profile wrapping comes in a diverse range of finishes with a clear protective film on the front, and a standard .020" thickness.

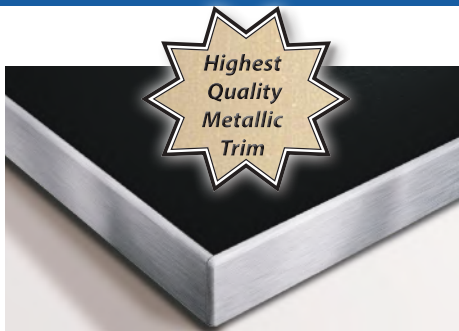

Peel & Stick Finishes Available



DESIGNED FOR ALL TRIM APPLICATIONS

- MATERIAL: Deposits of metallized plastic with a durable lacquered finish, laminated to a THERMOPLASTIC BACKER.
- PROTECTIVE COVER
- Can be sawed, cut or routed without delamination.
- CLEAN, FINISHED EDGES WITHOUT FILING
- Scratch resistant



250 FT. COIL NTP TRIM
(With Adhesive) .020 Thickness

Part #	Size
NTP-25-*	1/4"
NTP-50-*	1/2"
NTP-75-*	3/4"
NTP-875-*	7/8"
NTP-1-*	1"
NTP-1-25-*	1-1/4"
NTP-1-50-*	1-1/2"
NTP-2-*	2"
NTP-3-*	3"
NTP-6-*	6"
NTP-24-*	24"- 50 ft. coil

500 FT. COIL NTP TRIM
(Primed/No Adhesive) .020 Thickness

Part #	Size
ET-50-*	1/2"
ET-75-*	3/4"
ET-875-*	7/8"
ET-1-*	1"
ET-1-125-POL/C	1-1/8"
ET-1-25-*	1-1/4"
ET-1-50-*	1-1/2"
ET-2-*	2"
ET-3-*	3"
ET-6-*	6"
ET-24-*	24"- 50 ft. coil

■ NOTE: ET TRIMS ARE PRIMED FOR USE WITH AUTOMATIC EDGEBOARDING EXCEPT GLOSS BLACK

Matching 4' x 8' sheets are available. Please inquire.

Additional Widths are available - please call with your inquiry



DECORATIVE TRIMS

Cut Program Available
PLEASE INQUIRE

Half Round Trim



Material: PVC/Film - w/Foam Tape

Finishes Available

***POL/B - Polished Brass** ***POL/C - Polished Chrome**
unless otherwise noted

1/4"

Tape

PVC/Film
100 Ft. Coils - Flexible

Part #
2301-*

1/4"

Tape

Vinyl - 100 Ft. Coils
Brite Brass (*B/B) &
Brite Chrome (*B/C)

Part #
CFWW250-*

3/8" Light

Tape

PVC/Film
100 Ft. Coils - Flexible

Part #
2004-POL/C-100

Flat Trim

Material: ABS/Film - w/Foam Tape

Finishes Available

***POL/B - Polished Brass** ***POL/C - Polished Chrome**
unless otherwise noted

3/4"

TAPE

100 & 500 Ft. Coils
All Polished Chrome
PVC/film

Part #
6107-POL/C

3/4"

Tape

12 Ft. Lengths

Part #
2190-*

TOOLS

Multipurpose Cutter



GT-7000

- Heavy duty forged steel blade for extra tough materials
- Ergonomic handle for comfortable use

Optional Accessories:

CT-BLD BLADE	CT-MA	CT-SRA	CT-DRA	CT-RAA	CT-FA
MITER ANVIL For mitering at multiple angles	SINGLE RADIUS ANVIL For 1" dia. material	DOUBLE RADIUS ANVIL For 5/8" and 3/4" dia. material	RIGHT ANGLE ANVIL For 90° angles	FLAT ANVIL For straight and flat cuts	

Edge Trimmer



EBS-930

Double edge trimmer. Cuts both sides simultaneously, finishing operations. For edges up to 40mm. For larger edges it can be used as two independent edge trimmers. Top quality long life blades which are easy to replace once worn.

Replacement Blade: EBS-930-RB

Utility Knife

DIECAST UTILITY KNIFE

- High quality pewter diecast handle
- 10-steps positioning lock
- Lock blade compatible, each furnished with one blade



DCB-219K

WITH LARGE BREAKAWAY BLADE

- Blue plastic casing
- Includes one blade with 7-point segments
- Replacement blades available (BBK-80B)

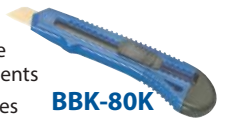

BBK-80K

Made in China

PNEUMATIC TOOLS

HAND HELD AIR HAMMERS



- OVER 1000 BLOWS PER MINUTE.
- NO SWINGING.
- Can be used anywhere the smallest hand can reach. Replaces wide variety of cumbersome hammers and mallets. No skilled personnel.
- CONTROL. A single hammer blow or excess of 1000 blows per minute. Adjustable from slightest hammer tap to heavy impact blows.
- VERSATILE. Easily interchangeable hammer tips of super soft hard plastic, steel and aluminum.
- PALM SIZE-LIGHTWEIGHT-SAFE.

DANAIR
HAND HELD HAMMER
AH15
(Supplied w/standard blue tip)

IMPORTED
HAND HELD HAMMER
AH25
(Supplied w/standard blue tip)

LEATHER TOOL GLOVE
FOR AH15 OR AH25 HAMMER
AS-706



REPLACEMENT PARTS

Part #	Description
T-15SS	Hammer Tip
T-15S	Hammer Tip
T-15M	Hammer Tip
T-15H	Hammer Tip
T-15AL	Hammer Tip
T-15ST	Hammer Tip
159	Stem
4-212	"O" Ring
163	Bumper
3-127	"O" Ring
158	Valve
3-114	"O" Ring
4-218	"O" Ring
157	Cap
2-031	"O" Ring
161	Exhaust Seat
162	Plug
156	Housing



HAMMER TIP
T-15SS (Super Soft Plastic) **Red**
T-15S (Soft Plastic) **Blue**
T-15M (Medium Plastic) **Black**
T-15H (Hard Plastic) **Yellow**
T-15AL (Aluminum)
T-15ST (Steel)

AS-OK-15 REPAIR KIT

INCLUDES:
1 - ALL-O-RINGS
1 - AS-ORL-O-RINGS LUBE
1 - 163 BUMPER

AS-319 STROKE CONTROL SPACER

(available as optional accessory)
SHORTENS STROKE BY 1/4"
REDUCES HAMMERING FORCE

CARBIDE TIPPED TEE MOULDING BLADES

2 Wing Blade

Part#	No. Of Wings	Slot Thickness
S055	2	.055"
S065	2	.065"
S1	2	.075"
S2	2	.080"
S3	2	3/32"
S4	2	1/8"
S5	2	3/16"
S6	2	1/4"



Complete Set

Part#	No. Of Wings	Slot Thickness
SJ-055	2	.055"
SJ-065	2	.065"
SJ-1	2	.075"
SJ-2	2	.080"
SJ-3	2	3/32"
SJ-4	2	1/8"
SJ-5	2	3/16"
SJ-6	2	1/4"



2 Wing w/Arbor & Bearing

4 Wing Blade

Part#	No. Of Wings	Slot Thickness
S7	4	.075"
S8	4	.080"
S9	4	3/32"
S10	4	1/8"
S11	4	3/16"
S12	4	1/4"
S13	4	.065"



Complete Set

Part#	No. Of Wings	Slot Thickness
SJ-7	4	.075"
SJ-8	4	.080"
SJ-9	4	3/32"
SJ-10	4	1/8"
SJ-11	4	3/16"
SJ-12	4	1/4"
SJ-13	4	.065"



4 Wing w/Arbor & Bearing

Arbor A1/B1

A1 Arbor w/Locknut & B1 Bearing w/Washer



- 5/16" Bore
- 1/4" Shank
- 1/2" Cut

TEE MOULDING TOOLS

EDGE TRIMMER 101

THE QUALITY HSS BLADE (3mm thick, 18% tungsten) has two cutting edges and, therefore, operates both forwards and backwards and effortlessly cuts off all projecting lippings neatly and completely flush-when the additional jaws are used with a chamfer of 30° or 45°. The chamfer is adjustable according to the spacing between the additional jaws. Supplied with a built-in blade and additional jaws 45° mounted, a pair of additional jaws 30° and on fence for plane parallel cutting--the latter for PVC and veneer edges.

With fence for veneer edge & PVC lippings



With additional jaws 45° or 30° for plastic lippings



101-TRIMMER
101XTRA-BLADE

FLUSH TRIMMER

This all metal hand tool features a precise high carbon steel cutting blade that trims excess material from the edge of the tee moulding face, creating a smooth flush table or counter surface. The unique circular blade can be rotated to expose a new sharp cutting surface. This feature eliminates the need for frequent sharpening. Heavy cast aluminum housing with ball bearing roller guides facilitates easy operation.



992006-000-0000
992007-000-0000

NOTCHING TOOLS

The most important "quarter inch" in mitering is that small portion of the barb which is removed by the notching tool. This special "V" cut enables the moulding to negotiate small radii and sharp corners for a clean, smooth installation.



Part#	Description	Punch Thickness
P900R	Vinyl Tee Moulding Notcher - cuts 1/4" radius	0.156"
1870A	Replacement Blade	-
P900A	Aluminum & Vinyl Notcher with 1/16" opening	0.050"
1840A	Replacement Blade (A-Notch)	-
P900V	Channel and Angle Notcher with 3/32" opening	0.090"
848A	Replacement Blade	-

3RD HAND HD



The 3rd Hand HD is the help you have been looking for. If you ever wished you had an extra hand, look no further. It is rugged, built to last a lifetime and it's never late for work! Brace, jack or support whatever you need.

- 360° articulating foot
- Pump jack for precision height adjustment
- Telescoping pole, 5' to 12' with ball detents for positive locking
- Great for hanging cabinets, drywall & crown moulding



Part#	Description
3-H-HAND-HD-5	3rd Hand single pack
3-H-2PK-3-HAND-5	3rd Hand twin pack

MAGNETIC STRIP

WITH ADHESIVE BACKING*



*The adhesive is rubber-based with a protective peel coat resistant to water, detergent and alcohol. It is not recommended for use in contact with solvent such as aliphatic or aromatic hydrocarbons, ketones, esters or chlorinated hydrocarbons.

Other Thicknesses & Widths Available. Special Die Cutting Available
- Minimums Apply - Please Inquire.

.030 THICK - 200 FT. ROLLS WITH ADHESIVE

Part #	Width	Ft. Per Case
MSA-1-0500	1/2"	1600 ft.
MSA-1-0750	3/4"	1200 ft.
MSA-1-1000	1"	800 ft.

.060 THICK - 100 FT. ROLLS WITH ADHESIVE

Part #	Width	Ft. Per Case
MSA-2-0500	1/2"	800 ft.
MSA-2-0750	3/4"	600 ft.
MSA-2-1000	1"	400 ft.

.120 THICK - 100 FT. ROLLS WITH ADHESIVE

Part #	Width	Ft. Per Case
MSA-3-0500	1/2"	600 ft.
MSA-3-0750	3/4"	400 ft.
MSA-3-1000	1"	300 ft.

DIGIMAG® MAGNETIC SHEET

.030" THICK - WITH GLOSS WHITE VINYL COVER

- Flexible
- Die cut shear cut or punch
- Available in sheet or rolls
- Works with solvent inkjet printers, including Roland, Mutch, Epson, Oce, HP, AGFA, and Minaki - (all registered)
- Screen printable
- Indoor/outdoor use
- Available in matte finish (Please Inquire)

2 FT. x 50 FT. ROLLS

Part #
MAG2450

12" x 24" SHEETS

Part #
MAG1202

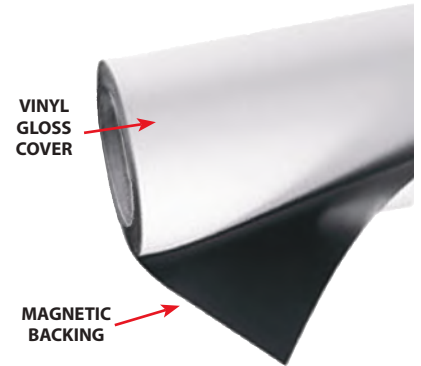

Magnaclamp®

THE EFFICIENT WAY OF HANGING SIGNS, BANNERS AND DISPLAY MATERIAL

- Unaffected by frost
- Wash over, squeegee over
- Neat appearance - no unsightly residue
- Leaves no residue if removed
- **LASTS FOR YEARS!**

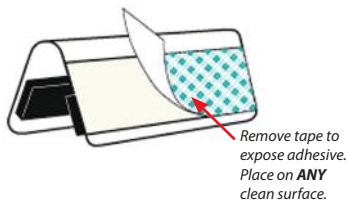
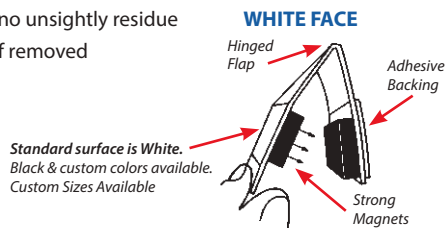

ADHESIVE BACK

Part #	Length
MC-03-WH	3"
MC-06-WH	6"
MC-24-WH	24"
MC-36-WH	36"

Magnaclamp II®

THE HARD-SHELL MAGNACLAMP® FOR THE UPSCALE LOOK

- Attaches to a flat surface with permanent adhesive
- Integrated hinge opens to accept signage and clamp shut for a secure hold.
- Black or White, 24" long with adhesive



Part #	Length
MCHS-24-BK	24"
MCHS-24-WH	24"

HOOK & LOOP



VELCRO® brand woven nylon hook and loop tapes are manufactured by a precise and refined weaving process which ensures uniformity of dimensions and construction.

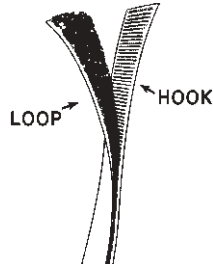

- STOCK COLORS: BLACK (*BK) & WHITE (*WH)
- SOLD IN FULL ROLLS ONLY

Standard Grade Fastening Tapes

- FOR INDOOR USE ONLY
- RUBBER BASED ADHESIVE

Part #	Description	Roll Length
HK-58-*	5/8" Hook	75'
LP-58-*	5/8" Loop	75'
HK-34-*	3/4" Hook	75'
LP-34-*	3/4" Loop	75'
HK-100-*	1" Hook	75'
LP-100-*	1" Loop	75'
HK-150-*	1-1/2" Hook	75'
LP-150-*	1-1/2" Loop	75'
HK-200-*	2" Hook	75'
LP-200-*	2" Loop	75'

Premium Grade Fastening Tapes

- FOR INDOOR / OUTDOOR USE
- ACRYLIC BASED ADHESIVE

Part #	Description	Roll Length
VH-625-*	5/8" Velcro Hook	75'
VL-625-*	5/8" Velcro Loop	75'
VH-750-*	3/4" Velcro Hook	75'
VL-750-*	3/4" Velcro Loop	75'
VH-1000-*	1" Velcro Hook	75'
VL-1000-*	1" Velcro Loop	75'
VH-2000-*	2" Velcro Hook	75'
VL-2000-*	2" Velcro Loop	75'

NOTE: OTHER SIZES/LENGTHS & DIE-CUTTING AVAILABLE - PLEASE INQUIRE

DOUBLE STICK FOAM TAPE

WITH PROTECTIVE COVER

Our rubber-based Double Stick Foam Tape works well on most surfaces including: glass, metals, painted metal, paper, finished wood and plastics (including low surface energy polyethylene and polypropylene). It is not recommended for plasticized vinyl, materials contaminated with internal or surface lubricants and surfaces that are not clean and dry. Removing the tape is best accomplished by "thumbing" it off gradually. Solvents such as MEK, lacquer thinner and turpentine will degrade the adhesive, but are hazardous to work with and can damage the surface being cleaned as well.

Polyethylene Foam Tape Rolls



- Available 1/32" or 1/16" thick
- 1/2", 3/4" or 1" Widths
- White (*WH) or Black (*BK)
- 216 Ft. Rolls

1/32" THICK

Part #	Width
RFT1-0500-*	1/2"
RFT1-0750-*	3/4"
RFT1-1000-*	1"

1/16" THICK

Part #	Width
RFT2-0500-*	1/2"
RFT2-0750-*	3/4"
RFT2-1000-*	1"

Clear Film Tape Rolls



- .5mil polyester film with 2mil adhesive
- Rubber based adhesive not recommended for direct UV exposure applications.
- Application temperature: 65°F-100°F
- Service temperature: -20°F-150°F
- Roll core: 3" Diameter -180 Ft.

Part #	Width
DK-0500	1/2"
DK-0750	3/4"
DK-1000	1"

COLOR U-CHANNEL MOULDING

Lengths: 12 Ft.
Material: Styrene

Colors Available

*WH - White *BK - Black *BE - Beige *SIL - Silver
unless otherwise noted

<p>Fits Up To 1/8"</p> <p>8 & 10 Ft. Lengths</p> <p>Part # 132-* Please Inquire</p>	<p>Fits Up To 1/8"</p> <p>8 & 10 Ft. Lengths</p> <p>Part # 130-*</p>	<p>Fits 1/8"</p> <p>Part # R104-581-*</p>	<p>Fits 3/16"</p> <p>Part # R104-582-*</p>
<p>Fits 1/8"</p> <p>8 Ft. Lengths Material: PVC</p> <p>Part # 106-4808-*</p>	<p>Fits 5/32"</p> <p>Material: High Gloss ABS/Film</p> <p>Part # 2326-BK</p>	<p>Fits 7/32"</p> <p>Part # R104-744-*</p>	<p>Fits 3/16"</p> <p>Material: Styrolux</p> <p>Part # 142F-*</p>
<p>Fits 1/4"</p> <p>Silver Material: PVC</p> <p>Part # 141-* 141-SIL</p>	<p>Fits 1/4"</p> <p>Part # R104-588-*</p>	<p>Fits Up To 1/4"</p> <p>8 & 10 Ft. Lengths</p> <p>Part # 131-*</p>	<p>Fits 5/16"</p> <p>Part # R104-4016-*</p>
<p>Fits 3/8"</p> <p>Part # 383-*</p>	<p>Fits 3/8"</p> <p>Part # R104-589-*</p>	<p>Fits Heavy 3/8"</p> <p>8 Ft. Lengths Material: Rigid PVC</p> <p>Part # 133-BK 133-SIL</p>	<p>Fits 1/2"</p> <p>Silver Material: PVC</p> <p>Part # 121-* 121-SIL</p>

PROTOTYPE SAMPLES

We are happy to provide samples for prototypes & design builds - Please Inquire.

COLOR U-CHANNEL MOULDING

Lengths: 12 Ft.
Material: Styrene

Colors Available

*WH - White *BK - Black *BE - Beige *SIL - Silver
unless otherwise noted

<p>Fits 1/2"</p> <p>Part # 212-*</p>	<p>Fits 1/2"</p> <p>Part # R104-683-*</p>	<p>Fits 9/16"</p> <p>Part # PLEC-*</p>	<p>Fits 5/8"</p> <p>Part # 585-*</p>
<p>Fits 5/8"</p> <p>Part # 158-*</p>	<p>Fits 5/8"</p> <p>Part # R104-554-*</p>	<p>Fits 3/4"</p> <p>Part # R104-569-*</p>	<p>Fits 3/4"</p> <p>Part # 341-* 341-SIL</p>
<p>Fits 1"</p> <p>Part # 100-*</p>	<p>Fits 1-1/16"</p> <p>Part # R104-5145-*</p>	<p>Fits 1-1/4"</p> <p>Part # 114-*</p>	<p>Fits 1-1/2"</p> <p>Part # 112-*</p>

<p>Fits 2"</p> <p>Part # 110-*</p>

PROTOTYPE SAMPLES

We are happy to provide samples for prototypes & design builds - Please Inquire.

ALUMINUM PROFILES & SHAPES

Wide Variety of Finishes
Available in 12 Ft. Lengths

Angle (Even/Uneven) Mouldings...pgs. 34-35
Cap & Divider Mouldings...pgs. 28-29
Channel Mouldings...pgs. 24-25
Corner Mouldings...pg. 33
Cove Mouldings...pg. 36
Filler Tee Mouldings...pg. 8
No Notch & Real Tee Mouldings...pg. 11
Price Tag Mouldings...pg. 43
Rounded Trim Mouldings...pg. 31
Showcase Mouldings...pg. 31
Sliding Door Track Mouldings...pg. 39
Z Bar Mouldings...pg. 75

Largest Stocking Distributor in the USA

UV STABILIZED U-CANNEL MOULDING

Cut Program Available
PLEASE INQUIRE

Lengths: 12 Ft.
Material: RPVC
Color: Satin White Sheen

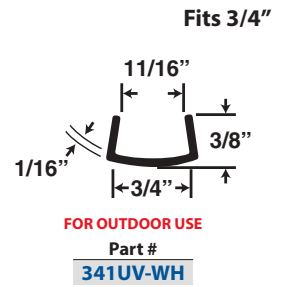
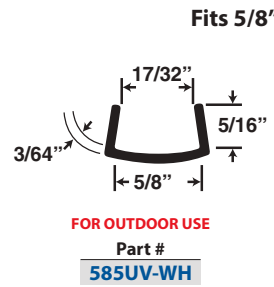
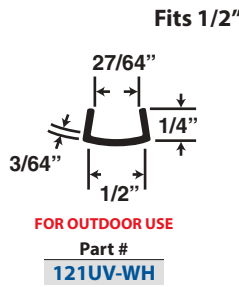
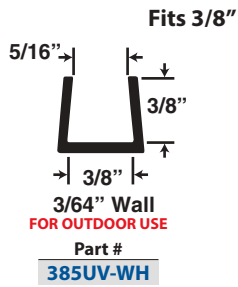
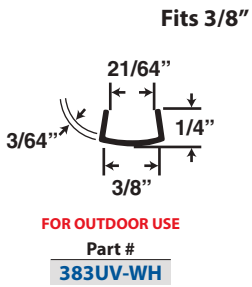

GLOSS BLACK U-CANNEL MOULDING

Lengths: 12 Ft.
Material: RPVC
Color: Gloss Black

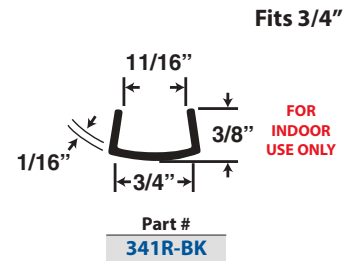
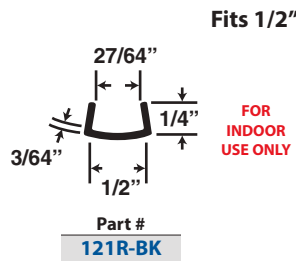
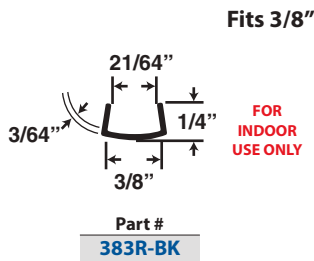

PROTOTYPE SAMPLES

We are happy to provide samples for prototypes & design builds - Please Inquire.

PLASTIC METALLIC CHANNEL MOULDING

Lengths: 12 Ft.
Material: ABS/Mylar
Finishes Available

*BRU/C - Brushed Chrome *POL/C - Polished Chrome
unless otherwise noted

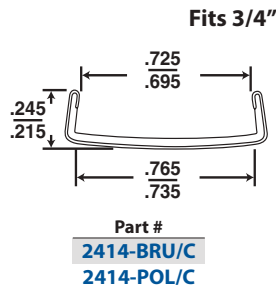
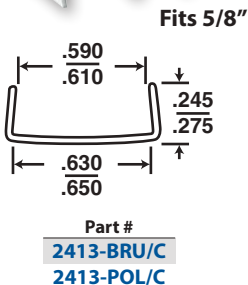
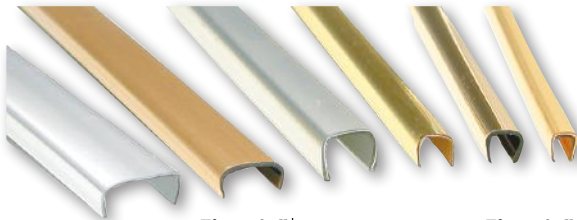

STAINLESS STEEL MIRROR MOULDING

Lengths: 12 Ft.
All Stainless Steel 430 Grade (Magnetic)
Polished-Shiny/Mirror Finish

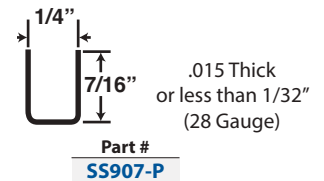
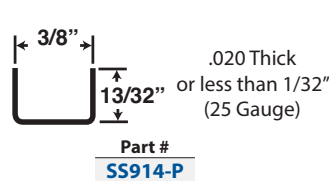

FOR MORE CAP & DIVIDER MOULDINGS, SEE PGS. 26-30

CLEAR U-CHANNEL MOULDING

Cut Program Available
PLEASE INQUIRE

Lengths: 12 Ft.
Material: PVC
unless otherwise noted

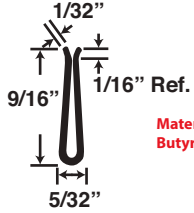
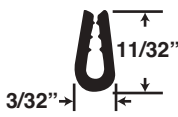
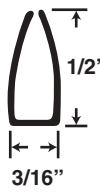
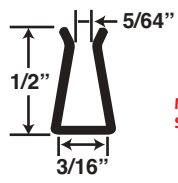
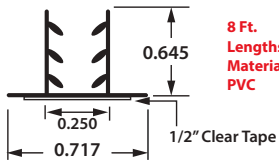
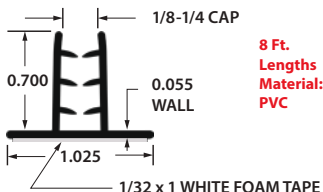
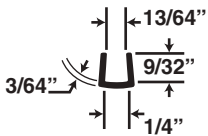
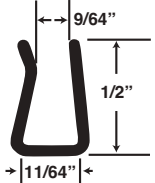
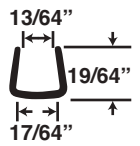
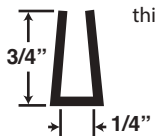
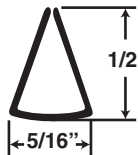
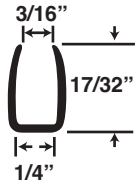
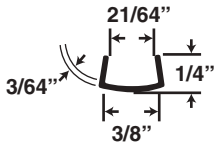
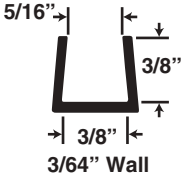
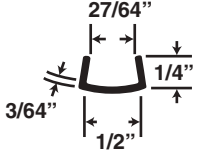
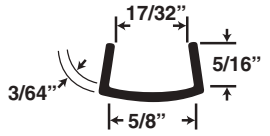
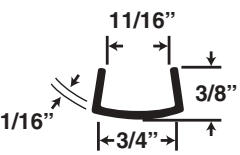
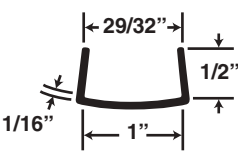
<p>Fits 1/16"</p>  <p>Material: Butyrate</p> <p>Part # 2128-CL</p>	<p>Fits 1/16"</p> <p>Gap adjustable</p>  <p>Material: Butyrate</p> <p>Part # 708-CL</p>	<p>Fits 1/8"</p>  <p>8 & 10 Ft. Lengths</p> <p>Part # 130-CL</p>	<p>Fits 3/16"</p>  <p>Material: Styrolux</p> <p>Part # 142F-CL</p>
<p>Fits 3/16"</p>  <p>8 Ft. Lengths Material: PVC</p> <p>Part # 106-4820-CL</p>	<p>Fits 1/8"-1/4"</p>  <p>1/8-1/4 CAP 0.055 WALL 1/32 x 1 WHITE FOAM TAPE</p> <p>8 Ft. Lengths Material: PVC</p> <p>Part # 106-4814-CL</p>	<p>Fits 1/4"</p>  <p>Part # 141-CL</p>	<p>Fits 11/64"</p>  <p>Part # 1059-CL</p>
<p>Fits 1/4"</p>  <p>Material: Butyrate</p> <p>Part # 1830-CL</p>	<p>Fits 1/4"</p> <p>.060 wall thickness</p>  <p>8 Ft. Lengths Material: Butyrate</p> <p>Part # P2743</p>	<p>Fits 1/4"</p>  <p>8 & 10 Ft. Lengths</p> <p>Part # 131-CL</p>	<p>Fits 1/4"</p>  <p>Material: Butyrate</p> <p>Part # 2014-CL</p>
<p>Fits 3/8"</p>  <p>Part # 383-CL</p>	<p>Fits 3/8"</p>  <p>3/64" Wall</p> <p>Part # 385-CL</p>	<p>Fits 1/2"</p>  <p>Part # 121-CL</p>	<p>Fits 5/8"</p>  <p>Part # 585-CL</p>
<p>Fits 3/4"</p>  <p>Part # 341-CL</p>	<p>Fits 1"</p>  <p>Part # 100-CL</p>	<p>PROTOTYPE SAMPLES We are happy to provide samples for prototypes & design builds - Please Inquire.</p>	

NYLA-GLIDE™ U-CHANNEL

Material: MDS Modified Nylon • Lengths: 100 Ft. Coils • Color: Dark Gray
unless otherwise noted

By adding Molybdenum Disulphide to Nylon 6, our profiles feature advanced mechanical and thermal properties over plain nylon including:

- **SUPERIOR HEAT RESISTANCE**...resist distortion to 300° with a maximum continuous use temperature of 250°
- **SUPERIOR WEAR RESISTANCE AND SURFACE LUBRICITY**...in many cases outwears metal and are not vulnerable to fretting & galvanic corrosion
- **SUPERIOR DIMENSIONAL STABILITY, STRENGTH AND RIGIDITY**...maintain better fit while having greater tensile and compression strength in use

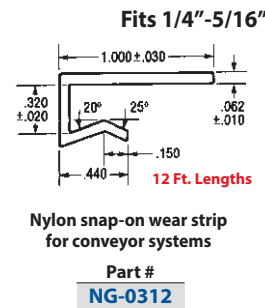
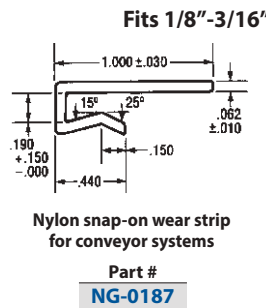
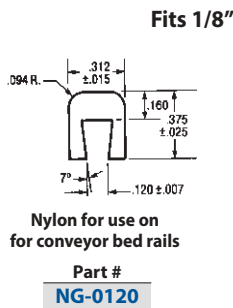
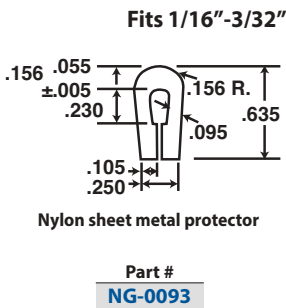
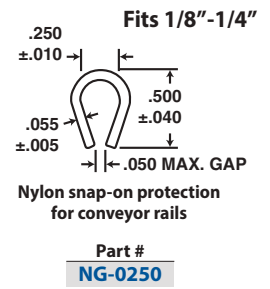
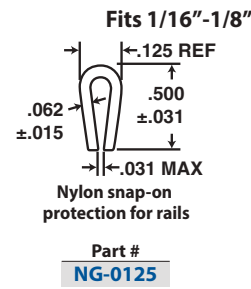
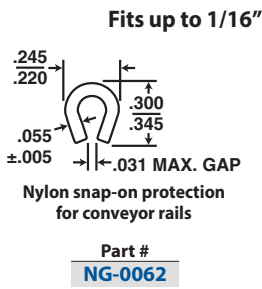

Square Back

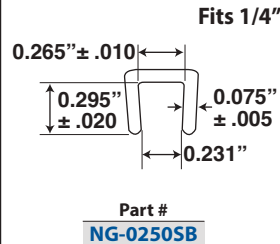
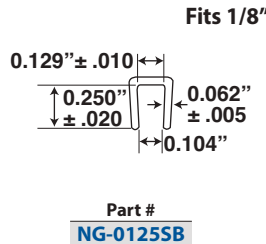
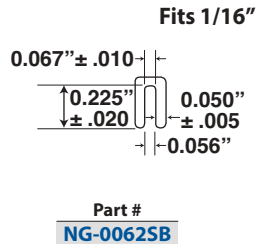



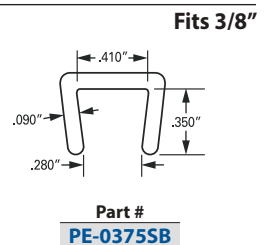
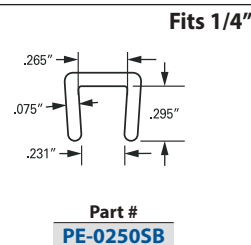
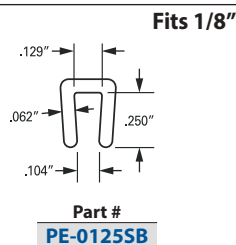
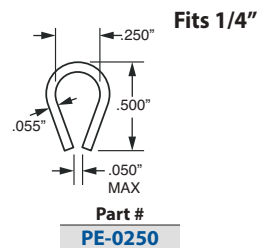
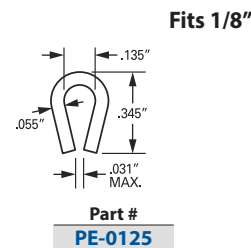
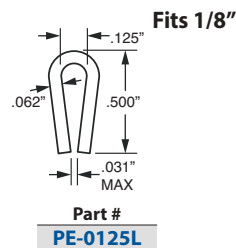
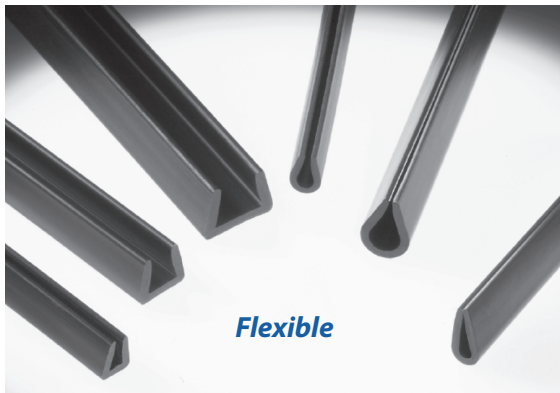

POLYETHYLENE U-CHANNEL

Lengths: 100 Ft. Coils • Color: Black

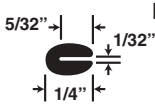

FLEXIBLE U-CANNEL Moulding

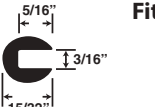
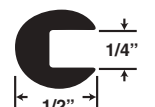
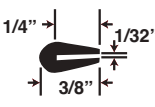
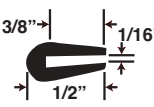
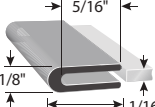
Material: Dense Neoprene • Rubber Black

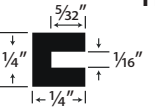
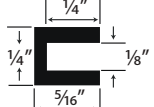
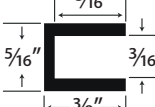



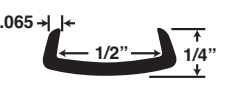
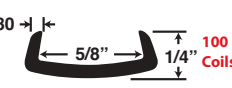
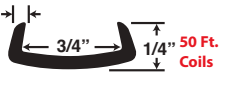



 <p>Fits 1/32"</p> <p>500 Ft. Coils</p> <p>Part # 113-1001</p>	 <p>Fits 1/16"</p> <p>500 Ft. Coils</p> <p>Part # 113-1002</p>	 <p>Fits 1/8"</p> <p>500 Ft. Coils</p> <p>Part # 113-1003</p>	 <p>Fits 3/16"</p> <p>500 Ft. Coils</p> <p>Part # 113-1004</p>
 <p>Fits 1/4"</p> <p>250 Ft. Coils</p> <p>Part # 113-1005</p>	 <p>Fits 1/32"</p> <p>500 Ft. Coils</p> <p>Part # 113-2000</p>	 <p>Fits 1/16"</p> <p>500 Ft. Coils</p> <p>Part # 113-2010</p>	 <p>Fits 1/16"</p> <p>500 Ft. Coils</p> <p>Part # 113-2013</p>
 <p>Fits 1/8"</p> <p>250 Ft. Coils</p> <p>Part # 113-2020</p>	 <p>Fits 1/16"</p> <p>1000 Ft. Coils</p> <p>Part # 113-3010</p>	 <p>Fits 1/8"</p> <p>1000 Ft. Coils</p> <p>Part # 113-3015</p>	 <p>Fits 3/16"</p> <p>500 Ft. Coils</p> <p>Part # 113-3030</p>

Material: Flexible PVC • Rubber Black

 <p>Fits 1/2"</p> <p>100 Ft. Coils</p> <p>Part # 808-500-BK</p>	 <p>Fits 5/8"</p> <p>100 Ft. Coils</p> <p>Part # 808-625-BK</p>	 <p>Fits 3/4"</p> <p>50 Ft. Coils</p> <p>Part # 808-750-BK</p>
--	--	---

Material: PVC w/Segmented Metal Core / Aluminum Core • Embossed Vinyl • Black or White

- Used for classic car, bus, snowmobile, air and other industries
- Made with a tough PVC cover with a metal segmented core / aluminum core, our channel provides an aesthetic and protective edge trim
- Easy to install with a strong clip-on grip
- Does not need tacking, gluing or riveting
- Used with metal, plastic, fiberglass, glass and wood to cover sharp edges and flanges.
- Labor saving product that can eliminate the need to deburr or remove sharp edge and painting.

 <p>Fits 1/2"</p> <p>150 Ft. Coils</p> <p>Part # 809-349-BK</p>	 <p>Fits 5/8"</p> <p>100 Ft. Coils</p> <p>Part # 809-837-BK</p>	 <p>Fits 3/4"</p> <p>100 Ft. Coils</p> <p>Part # 809-838-BK</p>	 <p>Fits 1/8"</p> <p>250 Ft. Coils</p> <p>Part # 812-125-BK</p> <p>Aluminum Core</p>
 <p>Fits 1/32" - 1/8"</p> <p>200 Ft. Coils</p> <p>Part # 810-318-BK</p> <p>Aluminum Core</p>	 <p>Fits 3/16" - 1/4"</p> <p>125 Ft. Coils</p> <p>Part # 810-443-BK</p> <p>Aluminum Core</p>	 <p>Fits 1/2"</p> <p>150 Ft. Coils</p> <p>Part # 810-449-BK</p> <p>Aluminum Core</p>	 <p>Fits 1/16"</p> <p>250 Ft. Coils</p> <p>Part # 815-062-375T</p> <p>Aluminum Core</p>

ALUMINUM CHANNEL MOULDING

Finishes Available

Lengths: 12 Ft. • Material: Aluminum

- *M - Mill - Dull Finish: As Extruded - May or May Not Have "Scratches"/Die Lines
 - *S - Satin/Clear Anodized - Dull, Matte Finish
 - *BK - Black Powder Coated Finish
 - *ORB - Oil Rubbed Bronze Finish
 - *P - Polished - Shiny/Mirror Finish
 - *BS - Brushed Satin - Lightly Brushed (Shows Grain) Satin Finish
 - *WH - Glossy White Powder Coated Finish
- Other Colors Available, Please Inquire. *Samples Are Available*



<p>Fits 1/8"</p> <p>Part # ALU757-*</p>	<p>Fits 1/4"</p> <p>Part # ALU257-*</p>	<p>New! Fits 1/4"</p> <p>Part # ALU782-*</p>	<p>Fits 9/32"</p> <p>Part # ALU1257-*</p>
<p>Fits 5/16"</p> <p>Part # ALU148-*</p>	<p>Fits 3/8"</p> <p>Part # ALU57-*</p>	<p>Fits 7/16"</p> <p>Part # ALU547-*</p>	<p>Fits 1/2"</p> <p>Part # ALU847-*</p>
<p>Fits 5/8"</p> <p>Part # ALU347-*</p>	<p>Fits 5/8"</p> <p>Part # ALU570-*</p>	<p>Fits 3/4"</p> <p>Part # ALU447-*</p>	<p>Fits 3/4"</p> <p>Part # ALU560-*</p>



COMING SOON! SHOWER ENCLOSURE EXTRUSIONS

- Aluminum Material
- Supports 1/2" & 3/8" frameless shower glass panels
- Available in multiple lengths
- Includes Header and choice of Channel...

Header

Provides support for glass panels that don't reach the ceiling.

- Rounded outside edges
- Available in 2 stock finishes: Brite Clear, Brushed Stainless Steel

C-Channels

- Flat outside edges
- Finishes: Anodized, Brite Clear, Brite Black, Brass, Bronze, Brushed Stainless Steel

U-Channels

- Rounded outside edges
- Finishes: Anodized, Brite Clear, Satin Black, Brushed Stainless Steel

**CALL
FOR UPDATED
INFORMATION**

ALUMINUM CHANNEL MOULDING

Lengths: 12 Ft. • Material: Aluminum

Finishes Available

- *M - Mill - Dull Finish: As Extruded - May or May Not Have "Scratches"/Die Lines
 - *S - Satin/Clear Anodized - Dull, Matte Finish
 - *BK - Black Powder Coated Finish
 - *P - Polished - Shiny/Mirror Finish
 - *BS - Brushed Satin - Lightly Brushed (Shows Grain) Satin Finish
 - *WH - Glossy White Powder Coated Finish
- Other Colors Available, Please Inquire. *Samples Are Available*

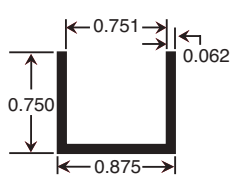

Fits 3/4"

Part #
ALU947-*

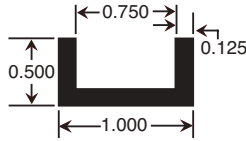

Fits 3/4"

Part #
ALU247-*

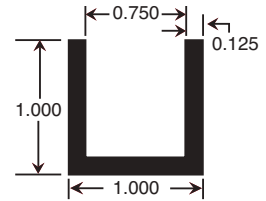

Fits 3/4"

Part #
ALU1041-S

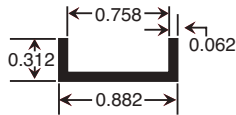

Fits 3/4"

Part #
ALU2161-S

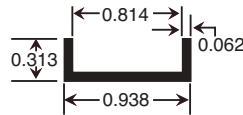

Fits 13/16"

Part #
ALU157C-*

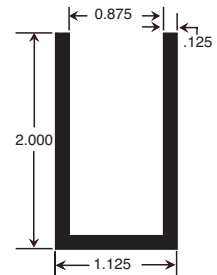

Fits 7/8"

Part #
ALU565-*

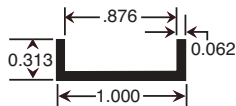

Fits 7/8"

Part #
ALU357-*

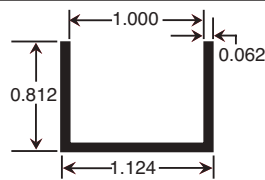

Fits 1"

Part #
ALU448-*

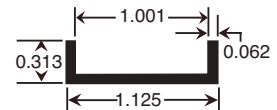

Fits 1"

Part #
ALU557-*

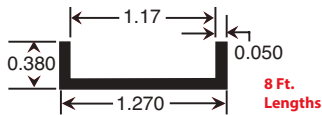

Fits 1-11/64"

8 Ft. Lengths

Part #
ALU450-S

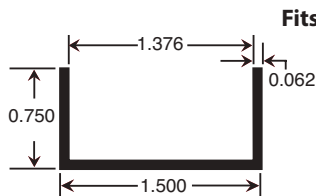

Fits 1-3/8"

Part #
ALU578-*

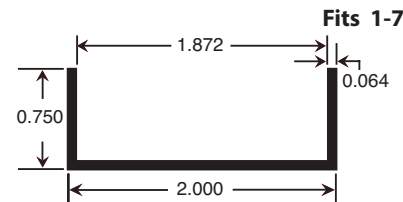

Fits 1-7/8"

Part #
ALU575-*

ALUMINUM "NO BOW" SHELF CHANNEL

Lengths: 8 Ft. - For 1/2", 5/8" & 3/4" Shelves

- *S - Clear Anodized - Dull, Matte Finish
- *BK - Black Powder Coated Gloss Finish
- *WH - White Powder Coated Gloss Finish

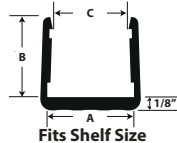
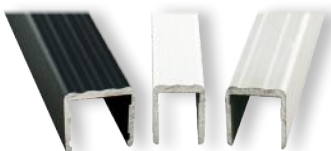

Part #	A	B	C
SHF-A500-*	43/64"	3/4"	1/2"
SHF-A625-*	51/64"	3/4"	5/8"
SHF-A750-*	15/16"	3/4"	3/4"

Available in Black, other finishes made-to-order

COLOR PLASTIC CAPPING

Lengths: 8 Ft.
Material: Styrene

Colors Available

*WH - White *BK - Black *BR - Brown *SIL - Silver

A = Available with Adhesive (1/2" Foam Tape)
unless otherwise noted



Cut Program Available
PLEASE INQUIRE

Fits 1/64"

12 Ft. Lengths
Material: PVC
Available only with
3/8" Film Tape

Part #
210A-*

Fits 1/16"

Material:
Rigid PVC
3/8" Foam Tape

Part #
2384-*
2384-*-A

Fits 1/16"

Part #
616-*
616-*-A

Fits 1/8"

Material:
PVC
Silver

Part #
600-*
600-*-A
600-SIL
600-SIL-A

Fits 1/8"

Part #
P640-*

Fits 1/8"

Part #
P630-WH

Fits 1/8"

1/2" x 1/32"
Acrylic
Adhesive
Foam Tape

Material:
ABS

Part #
1135-*
1135-*-A

Fits 3/16"

Part #
605-*
605-*-A

Fits 1/4"

Material:
PVC
Silver

Part #
650-*
650-*-A
650-SIL
650-SIL-A

Fits 1/4"

Material:
ABS

Part #
1032-*

Fits 1/4"

Part #
P641-*

Fits 1/4"

Part #
P631-*

Fits 3/8"

Part #
654-*

Fits 1/2"

Part #
2395-BK

Fits 1/2"

3/4" Foam Tape

Part #
652-*
652-*-A

Fits 5/8"

Part #
4068-*

Fits 3/4"

Part #
4069-*



COLOR PLASTIC DIVIDER

Cut Program Available
PLEASE INQUIRE

Lengths: 8 Ft.
Material: Styrene

Colors Available

*WH - White *BK - Black *BR - Brown *SIL - Silver

A = Available with Adhesive (1/2" Foam Tape)

unless otherwise noted

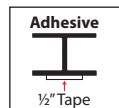

For matching Cap Moulding,
see previous page

Fits 1/16"

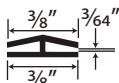

Part #
2383-*
2383-*-A

Material:
Rigid PVC

Fits 1/16"

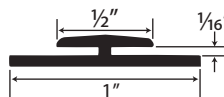

Part #
P610-*
P610-*-A

Fits 1/8"

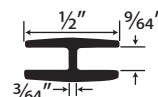

Part #
P611-*

Fits 1/4" Even Leg

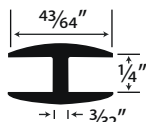

Part #
P612-*

Fits 1/8" Even Leg

Dividers with 11/16" Legs

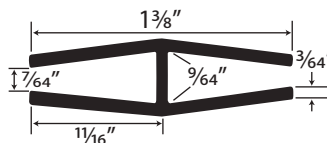

Part #
883-*

Fits 1/8"

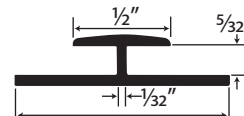

Part #
P601-*
P601-*-A
P601-SIL
P601-SIL-A

Silver
Material:
PVC

Fits 3/16"

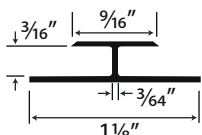

Part #
P604-*
P604-*-A

Fits 1/8"

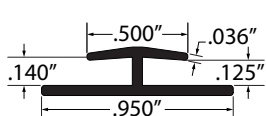

Part #
1134-*

Material:
ABS

Fits 1/4"

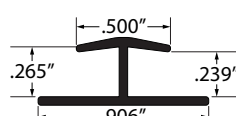

Part #
1031-*

Material:
ABS

Fits 1/4"

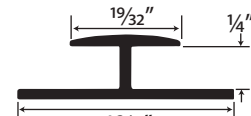

Part #
P651-*
P651-*-A
P651-SIL
P651-SIL-A

Silver
Material:
PVC

Fits 5/16"

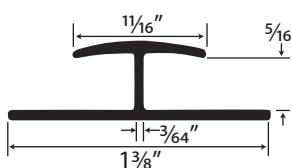

Part #
P660-*

Fits 3/8"

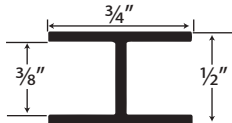

Part #
4158-*

Fits 1/2"

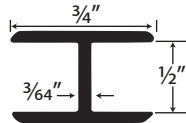

Part #
4050-*

Fits 3/4"

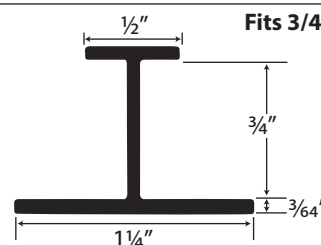

Part #
P750-*

Fits 3/4" Even Leg

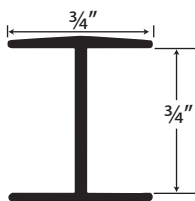

Part #
P751H-*

PLASTIC CAP & DIVIDER SETS

COLOR

Cap	Divider	Size	Cap	Divider	Size
2384-*	Works with 2383-*	1/16"	650-*	Works with P651-*	1/4"
616-*	Works with P610-*	1/16"	1032-*	Works with 1031-*	1/4"
600-*	Works with P601-*	1/8"	652-*	Works with 4050-*	1/2"
1135-*	Works with 1134-*	1/8"	4069-*	Works with P750-*	3/4"

CLEAR

Cap	Divider	Size
846-*	Works with 2028-*	1/8"
2030-*	Works with 2029-*	1/4"

ALUMINUM CAPPING

Lengths: 12 Ft. • Material: Aluminum

Finishes Available



- *M, MH (w/holes) - Mill - Dull Finish - As Extruded - May or May Not Have "Scratches"/Die Lines
 - *S, SH (w/holes) - Satin/Clear Anodized - Dull Matte Finish
 - *P, PH (w/holes) - Polished/Mechanical - Shiny/Mirror Finish
 - *ORB, ORBH (w/holes) - Oil Rubbed Bronze Anodize Finish
 - *BK, BKH (w/holes) - Black Powder Coated Finish
 - *WH, WHH (w/holes) - Glossy White Powder Coated Finish
- Samples Are Available

Fits 1/16"

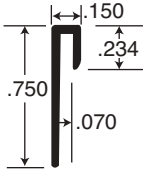

Part #
ALU2013-*

Fits 1/16"

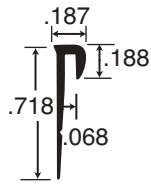

Part #
ALU2334-*

Fits 1/8" to 5/32"

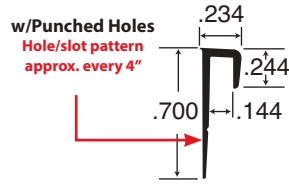

Part #
ALU7441-S

Fits 5/32"

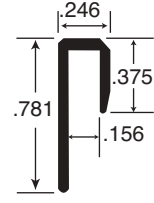

Part #
ALU2000-*

Fits 3/64"

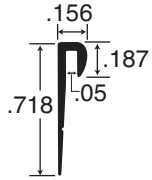

Part #
ALU0204-S

Fits 3/32"

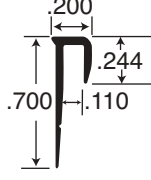

Part #
ALU0214-S

Fits 3/16"

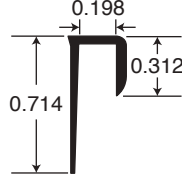

Part #
ALU0316-S

Fits 1/8"

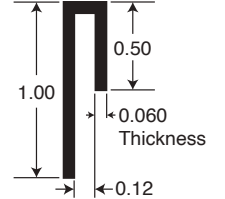

Part #
ALU4637-*

Fits 1/4" to 9/32"

w/Punched Holes
Hole/slot pattern
approx. every 4"

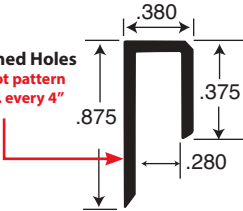

Part #
ALU851-*

Fits 1/4" to 9/32"

w/Punched Holes
Hole/slot pattern
approx. every 4"

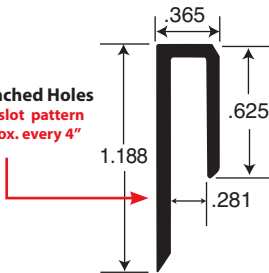

Part #	Description
ALU961-*	Holes
ALU961-M	No Holes

Fits 1/2"

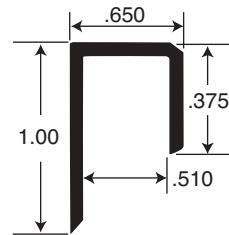

Part #
ALU1851-*

ALUMINUM DIVIDER

Lengths: 12 Ft. • Material: Aluminum

- *M - Mill - Dull Finish: As Extruded - May or May Not Have "Scratches"/Die Lines
 - *S - Satin/Clear Anodized - Dull Matte Finish
 - *P - Polished/Mechanical - Shiny/Mirror Finish
 - *ORB - Oil Rubbed Bronze Anodize Finish
 - *BK - Black Powder Coated Finish
 - *WH - Glossy White Powder Coated Finish
- Samples Are Available

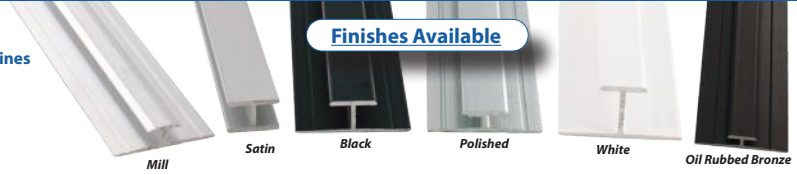

Finishes Available

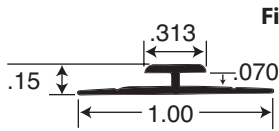

Fits 1/16"

Part #
ALU0023-*

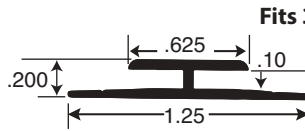

Fits 3/32"

Part #
ALU5044-S

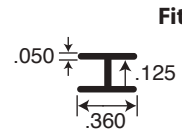

Fits 1/8"

Part #
ALU0829-S

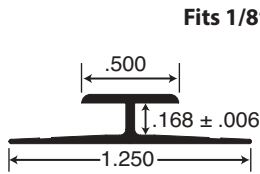

Fits 1/8" to 5/32"

Part #
ALU849-*

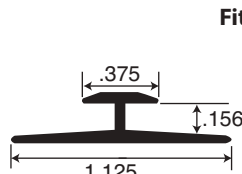

Fits 5/32"

Part #
ALU5639-*

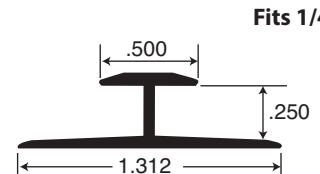

Fits 1/4"

Part #
ALU1798-*

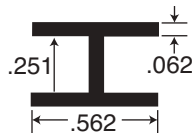

Fits 1/4"

Part #
ALU4299-*

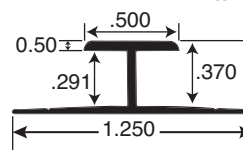

Fits 1/4" to 9/32"

Part #
ALU850-*

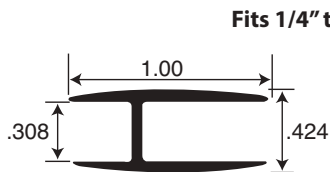

Fits 1/4" to 9/32"

Part #
ALUT155-S

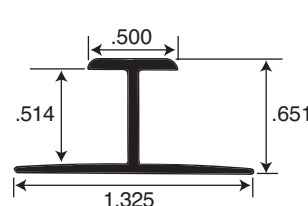

Fits 1/2"

Part #
ALU1850-*

STAINLESS STEEL CAP & CORNER DIVIDER

Lengths: 12 Ft.

Material: All Stainless Steel 430 Grade (Magnet) • Polished-Brite Dipped Polish

DIVIDER

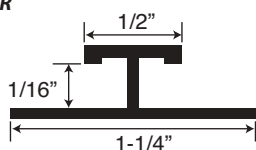

Fits 1/16"

Part #
SS1450-P

CAP

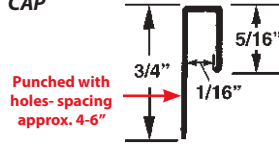

Fits 1/16"

Part #
SS1451-P

CAP

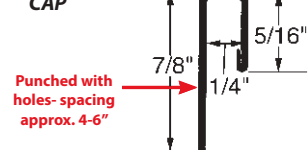

Fits 1/4"

Part #
SS851-P

CLEAR PLASTIC CAPPING

Lengths: 12 Ft.

A = Available with Adhesive (1/2" Clear Tape)
unless otherwise noted

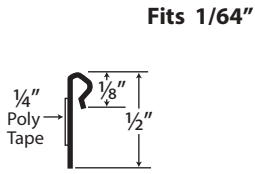
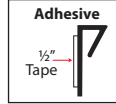

Material: PVC

Part #
12A-CL

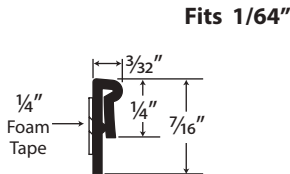

8 Ft. Lengths - Material: Styrolux

Part #
220-CL-A

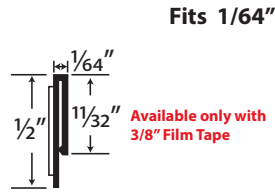

Material: PVC

Part #
210-CL
210A-CL

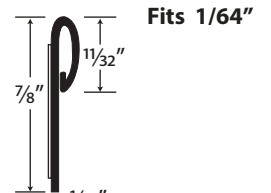

Material: PVC

Part #
23-CL
23A-CL

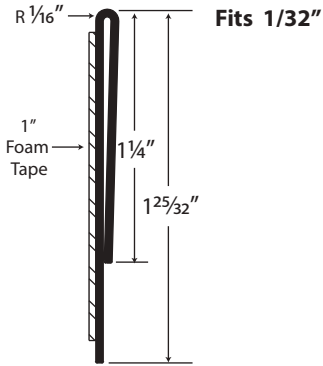

8 Ft. Lengths - Material: Styrolux

Part #
55-5949
55-5949A

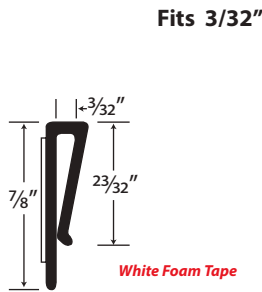

Material: Butyrate

Part #
847-CL
847A-CL

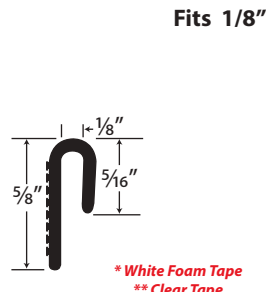

Material: Polyester

Part #
846-CL
***846A-CL**
****846-CL-CLA**

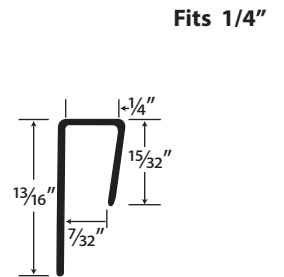

Material: Butyrate

Part #
2030-CL
2030-CL-CLA

CLEAR PLASTIC DIVIDER

Lengths: 8 Ft. • Material: Rigid PVC/Dual Durometer

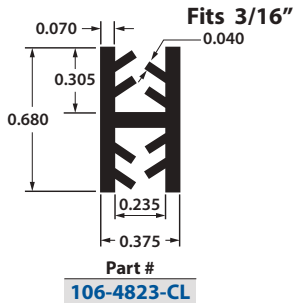

Part #
106-4823-CL

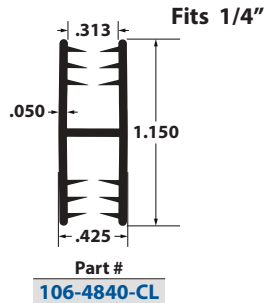

Part #
106-4840-CL

Lengths: 12 Ft. • Material: Butyrate

A = Available with Clear Adhesive

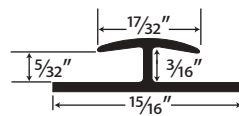

Part #
2028-CL
2028-CL-CLA

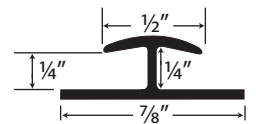
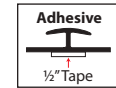

Part #
2029-CL
2029-CL-CLA

CLEAR PLASTIC JOINER MOULDING

Lengths: 8 Ft. • Material: Butyrate • Fits 1/4" Material

Divider

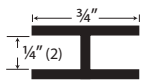

.050 Wall Thickness

Part #
P2658

2-Way Corner

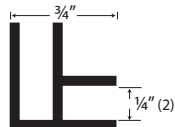

.050 Wall Thickness

Part #
P2718

3-Way Corner

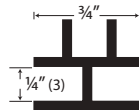

.050 Wall Thickness

Part #
P2719

4-Way Channel

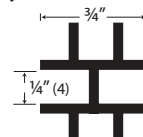

.060 Wall Thickness

Part #
P2720

U-Channel

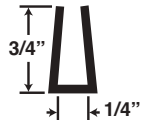

.060 Wall Thickness

Part #
P2743

GUARD Moulding

BUMPER GUARD Moulding

Material: Polyethylene

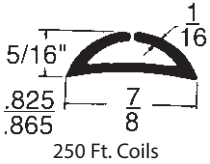

250 Ft. Coils

Part #	Color
K106-544-BK	Black
K106-544-BR	Brown

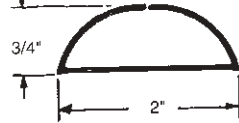
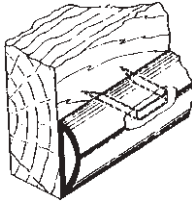

12 Ft. Lengths

Part #	Color
K106-555-BK	Black

INDUSTRIAL BUMPER Moulding w/ADHESIVE

Material: PVC

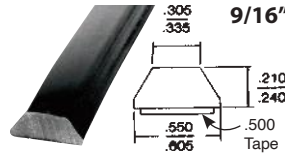

100 Ft. Coils

Part #	Color
2122-BK	Black

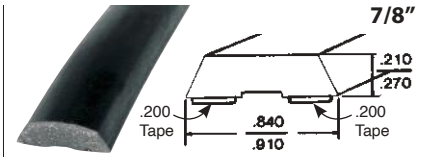

100 Ft. Coils

Part #	Color
1968-BK	Black

CHAIR EDGE GUARD Moulding

Lengths: 100 & 600 Ft. Coils

Material: Vinyl

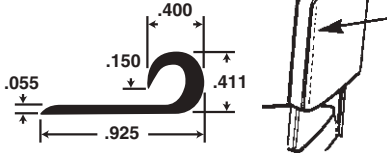

Part #	Color
403-023-000-0600R	Clear

TABLE GUARD Moulding

Lengths: 100 & 500 Ft. Coils

Staple To Surface

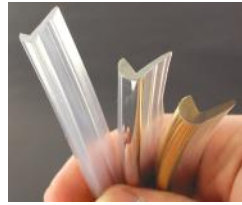

Material: Vinyl

Part #	Color
101-CL	Clear



Material: PVC/Film

Part #	Color
101-B/B	Brite Brass
101-B/C	Brite Chrome



ALUMINUM SHOWCASE Moulding

Lengths: 12 Ft.

Finishes Available

- *M - Mill - Dull Finish: As Extruded
- May or May Not Have "Scratches"/Die Lines
- *P, PH (w/holes) - Polished/Mechanical - Shiny/Mirror Finish
or Brite Dip Anodize
- *S - Satin/Clear Anodized - Dull Matte Finish



Part #	A	B	C	D
ALU235-S	5/16"	3/8"	3/4"	1/16"
ALU237-*	3/4"	39/64"	1-5/8"	3/64"
ALU239-*	3/4"	1-1/4"	2-1/8"	1/16"

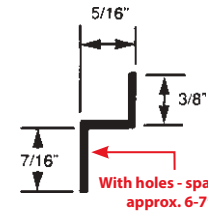

Z-Clip

Part #
ALU113-P

With holes - spacing approx. 6-7"

ALUMINUM OVERLAP FACE NOSING

Lengths: 12 Ft.
w/Countersunk Holes

Finishes Available

- *M (w/holes) - Mill - Dull Finish: As Extruded
- May or May Not Have "Scratches"/Die Lines
- *P (w/holes) - Polished/Mechanical - Shiny/Mirror Finish
or Brite Dip Anodize
- *BS (w/holes) - Brushed Satin - Lightly Brushed
(Shows Grain) Satin Finish

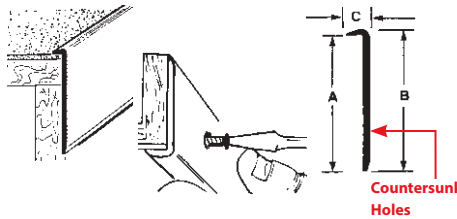

Part #	Hole Spacing	Underlip A	Overall B	Lip C
ALU968-*	6"	5/8"	11/16"	1/4"
ALU228-*	7"	3/4"	13/16"	1/4"
ALU128-*	7"	7/8"	15/16"	1/4"
ALU328-*	6"	1-1/4"	1-5/16"	1/4"
ALU428-*	7"	1-5/8"	1-11/16"	1/4"

ALUMINUM ROUNDED TRIM

Lengths: 12 Ft.
w/Holes - 6" on Center
Finishes Available

- *M (w/holes) - Mill - Dull Finish: As Extruded
- May or May Not Have "Scratches"/Die Lines
- *S (w/holes) - Satin/Clear Anodized - Dull Matte Finish

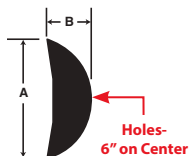

Part #	A	B
ALU436-*	3/8"	5/32"
ALU437-*	1/2"	3/16"
ALU438-*	3/4"	3/16"
ALU439-*	1"	3/16"

ALUMINUM ROUNDED EDGE TRIM

Lengths: 12 Ft.
w/Holes - 6" on Center
Finishes Available

- *M (w/holes) - Mill - Dull Finish: As Extruded
- May or May Not Have "Scratches"/Die Lines
- *S (w/holes) - Satin/Clear Anodized - Dull Matte Finish

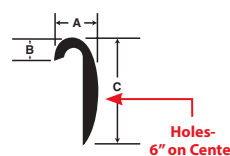

Part #	A	B	C
ALU427-S	3/8"	3/16"	15/16"
ALU429-*	3/8"	3/16"	1-11/64"

PLASTIC CORNER CHANNEL Moulding

Cut Program Available
PLEASE INQUIRE

90° Corner Channel



Lengths: 12 Ft.
Material: Styrene
Colors Available

*WH - White *BK - Black *BR - Brown ▲ *DG - Dove Gray ▲
unless otherwise noted

▲ 5000 ft. minimum apply



Fits 1/16"

Part Tapers For Friction Fit

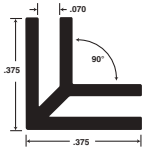

Part #
107-680-*

Fits 1/16"

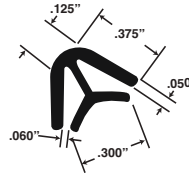

Gloss finish closely matches
Acrylic and PETG sheets

Color Clear Others Available Min. Apply
Styrolux - 8 Ft. Lengths

Part #
107-681-*

Fits 1/8"

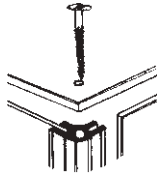
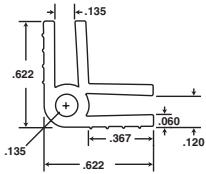

Part #
184-*

Fits 1/8"

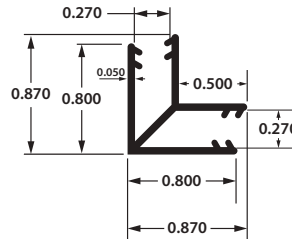

Part #
106-4830-CL

Fits 3/16"

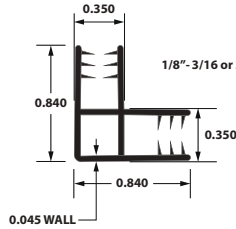

Part #
106-4828-CL

Fits 1/4"

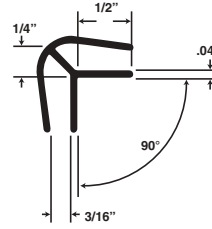

8 Ft. Lengths

Part #
107-664-*

Fits 1/2"

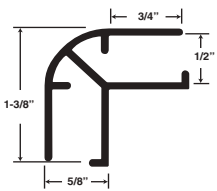

8 Ft. Lengths

Part #
107-687-*

Fits 5/8"

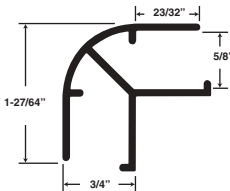

8 Ft. Lengths

Part #
107-688-*

Fits 3/4"

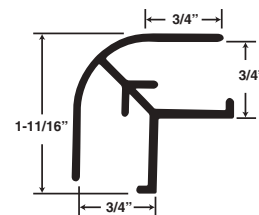

8 Ft. Lengths

Part #
107-689-*

60° Corner Channel



Lengths: 8 Ft.
Material: Styrene
Colors Available

*WH - White *BK - Black *BR - Brown ▲ *DG - Dove Gray ▲

▲ 5000 ft. minimum apply

Fits 1/4"

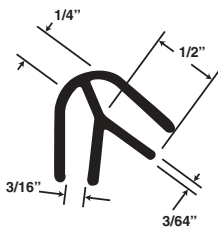

Part #
107-665-*

Fits 1/2"

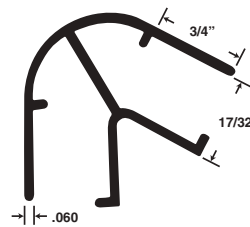

Part #
107-667-*

ALUMINUM OUTSIDE CORNERS

Lengths: 12 Ft. • Fits 3/4" Panel Boards • Patent #4840440

Finishes Available

*S - Satin/Clear Anodized - Dull, Matte Finish

<p>Joiner</p> <p>Part # ALU5164-S</p>	<p>End Cap</p> <p>Part # ALU5299-S</p>	<p>90° Angle</p> <p>Part # ALU5116-S</p>	<p>90° Angle</p> <p>Part # ALU5163-S</p>
<p>90° Angle</p> <p>Part # ALU5272-S</p>	<p>135° Angle</p> <p>Part # ALU5162-S</p>	<p>Shelf Support</p> <p>Part # ALU5165-S</p>	<p>Instructions: 2 Cutting Methods</p> <ol style="list-style-type: none"> Using Table saw Using 5 piece cutter head w/shaper <p>Part #: CW-TOOLS (sold separately, please inquire)</p>

ALUMINUM CORNERS

Lengths: 12 Ft.

Finishes Available

*M - Mill - Dull Finish: As Extruded - May or May Not Have "Scratches"/Die Lines

*P - Polished - Shiny/Mirror Finish

*S - Satin/Clear Anodized - Dull, Matte Finish

<p>INSIDE CORNER</p> <p>Fits 1/16"</p> <p>Part # ALU7792-*</p>	<p>INSIDE CORNER</p> <p>Fits 9/32"</p> <p>Part # ALU853-*</p>	<p>INSIDE CORNER</p> <p>Fits 1/2"</p> <p>Part # ALU1853-S</p>	<p>INSIDE CORNER</p> <p>Fits 3/4"</p> <p>Part # ALU1855-*</p>
<p>OUTSIDE CORNER</p> <p>Fits 1/16"</p> <p>Part # ALU7791-*</p>	<p>OUTSIDE CORNER</p> <p>Fits 1/4"</p> <p>Part # ALU5656-*</p>	<p>OUTSIDE CORNER</p> <p>Fits 9/32"</p> <p>Part # ALU852-*</p>	<p>OUTSIDE CORNER</p> <p>Fits 1/2"</p> <p>Part # ALU1852-*</p>
<p>OUTSIDE CORNER</p> <p>Fits 3/4"</p> <p>Part # ALU1854-*</p>	<p>OUTSIDE CORNER</p> <p>Fits 3/4"</p> <p>Part # ALU1857-*</p>	<p>2-WAY CORNER</p> <p>Fits 1/4"</p> <p>Part # ALU0315-S</p>	<p>2-WAY CORNER</p> <p>Fits 3/4"</p> <p>Part # ALU6314-S</p>

ALUMINUM EVEN ANGLE MOULDING

Lengths: 12 Ft.
Material: Aluminum

Finishes Available

*M - Mill - Dull Finish - As Extruded - May or May Not Have "Scratches"/Die Lines

*P - Polished/Mechanical- Shiny/Mirror Finish

*S - Satin/Clear Anodized - Dull, Matte Finish

*BK - Black Anodized Finish

Special Order: Other Colors Available, Please Inquire

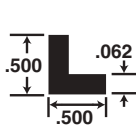

1/2" x 1/2"

Part #
ALU269-*

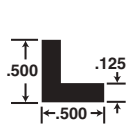

1/2" x 1/2"

Part #
ALU269-18-*

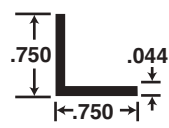

3/4" x 3/4"

Part #
ALU222-*

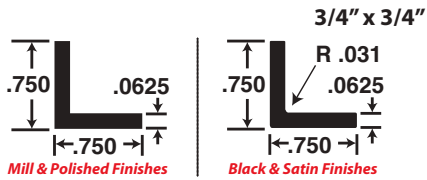

3/4" x 3/4"

Part #
ALU369-*

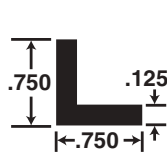

3/4" x 3/4"

Part #
ALU449-*

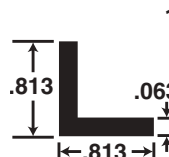

13/16" x 13/16"

Part #
ALU136-*

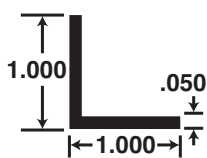

1" x 1"

Part #
ALU444-*

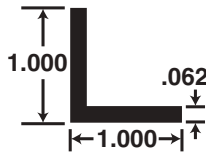

1" x 1"

Part #
ALU469-*

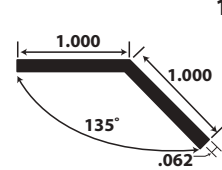

1" x 1" (135°)

Part #
ALU469-135-*

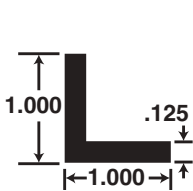

1" x 1"

Part #
ALU749-*

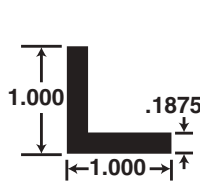

1" x 1"

Part #
ALU749-316-*

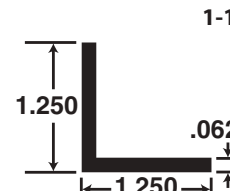

1-1/4" x 1-1/4"

Part #
ALU569-*

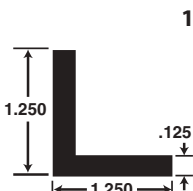

1-1/4" x 1-1/4"

Part #
ALU5569-*

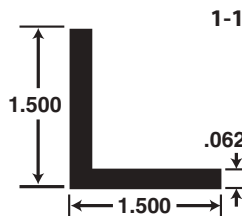

1-1/2" x 1-1/2"

Part #
ALU1569-*

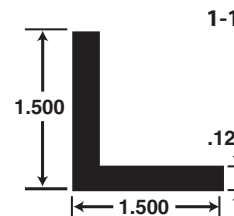

1-1/2" x 1-1/2"

Part #
ALU1569-18-*

ALUMINUM EVEN ANGLE MOULDING

Lengths: 12 Ft.
Material: Aluminum

Finishes Available

*M - Mill - Dull Finish: As Extruded - May or May Not Have "Scratches"/Die Lines

*P - Polished/Mechanical - Shiny/Mirror Finish

*S - Satin/Clear Anodized - Dull, Matte Finish

Special Order: Other Colors Available, Please Inquire

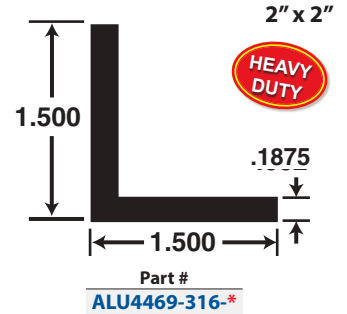
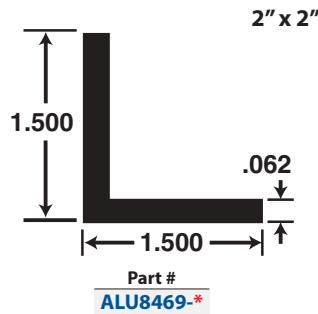
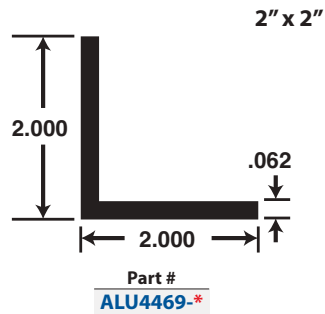
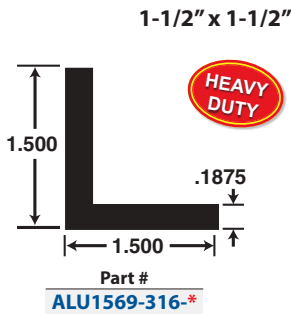

FOR STAINLESS STEEL ANGLE CORNER GUARDS, SEE PAGE 100

COMING SOON!

PLASTIC ANGLE MOULDING

- 8 FT. LENGTHS • WHITE STYRENE MATERIAL • PAINTABLE
- THICKNESS: 6mm (1/4") & 10mm (3/8") - FOR 2" & 3" SIZES
- 1/16" THICK PEEL & STICK ADHESIVE FOR EASY ATTACHMENT
- EVEN & UNEVEN ANGLES AVAILABLE

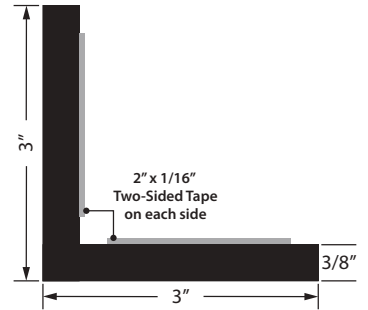
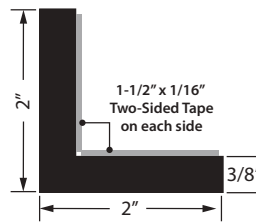
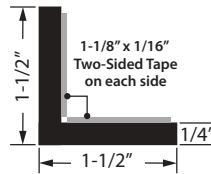
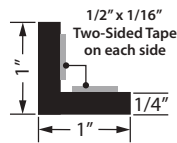
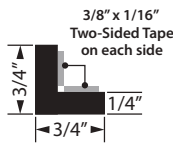
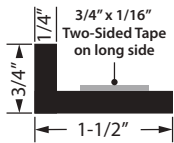

ALUMINUM UNEVEN ANGLE MOULDING

Lengths: 12 Ft.
Material: Aluminum

Finishes Available

*M - Mill - Dull Finish: As Extruded - May or May Not Have "Scratches"/Die Lines

*P, PH (w/holes) - Polished/Mechanical - Shiny/Mirror Finish

*BSH (w/holes) - Brushed Satin - Lightly Brushed (Shows Grain) Satin Finish

*S - Satin/Clear Anodized - Dull, Matte Finish

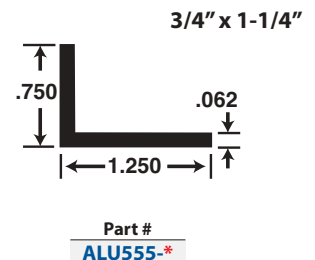
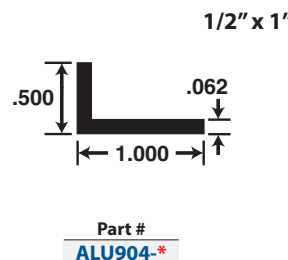
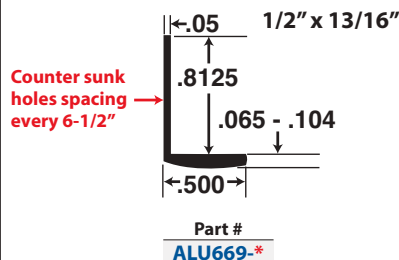
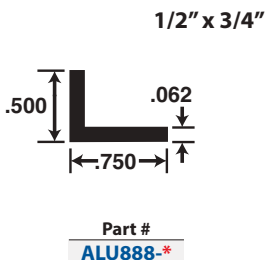
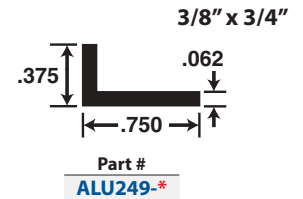
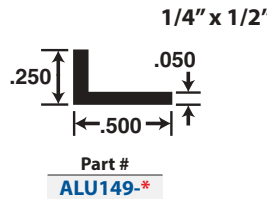

PLASTIC CLEAR RIGHT ANGLE MOULDING

Cut Program Available
PLEASE INQUIRE



Part #
519-CL



Part #
520-CL

Lengths: 12 Ft.
Material: Butyrate

approx. .040 thickness

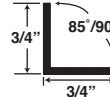

Part #
1748-CL

approx. .070 thickness

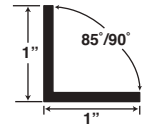

Part #
1749-CL

approx. .095 thickness

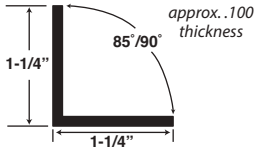

Part #
1750-CL

approx. .100 thickness

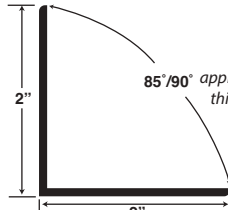

Part #
1755-CL

approx. .095 thickness

PLASTIC COLOR ANGLE MOULDING W/ADHESIVE

Lengths: 12 Ft. • Material: Styrene
Colors Available

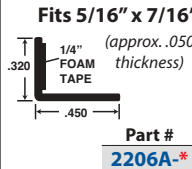

Part #
2206A-*

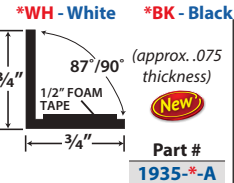

Part #
1935-A

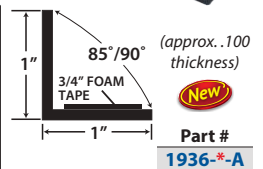

Part #
1936-A

PLASTIC METALLIC ANGLE MOULDING W/ADHESIVE

Lengths: 12 Ft. • Material: ABS/Mylar

Finishes Available

*POL/B - Polished Brass

*POL/C - Polished Chrome

*BRU/C - Brushed Chrome

Please inquire as finishes vary from style to style

Fits 3/8"

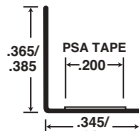

Part #
2406-POL/C

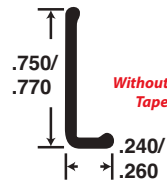

Part #
2163-*

ALUMINUM & STAINLESS STEEL COVE MOULDING

Lengths: 12 Ft.

Finishes Available

*P, *PH (w/holes) - Mechanical Polish - Shiny/Mirror Finish

*S - Satin/Clear Anodized - Dull, Matte Finish

*BS, BSH (w/holes) - Brushed Satin - Lightly Brushed (Shows Grain) Satin Finish

We can also supply custom orders without holes - minimums apply - please inquire.

Reverse cove moulding is used to cover up seams or joints wherever two perpendicular planes meet. The sink top to its backplash or the ceiling to a wall surface represent typical applications for which our reverse cove moulding was designed. The leg of the profile seals tightly against both surfaces to lend a cleanly trimmed appearance to the finished product.

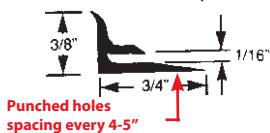

Part #
ALU141-PH

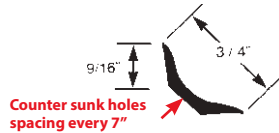

Part #
ALU121-PH



Part #
ALU1016-PH

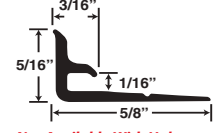

Part #
ALU426-S

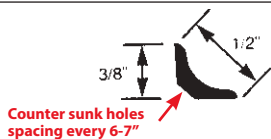

Part #
ALU441-PH

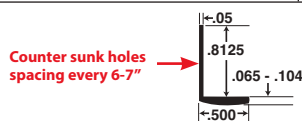

Part #
ALU669-*

STAINLESS STEEL COUNTER EDGE SNAP-ON MOULDINGS

Grade 430 (Magnetic)

Part #
SS801A-P
SS806-P

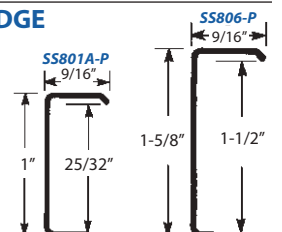

PLASTIC COLOR RIGHT ANGLE MOULDING

Cut Program Available
PLEASE INQUIRE

Lengths: 12 Ft.
Material: Styrene

Colors Available

*WH - White *BK - Black *BR - Brown
unless otherwise noted

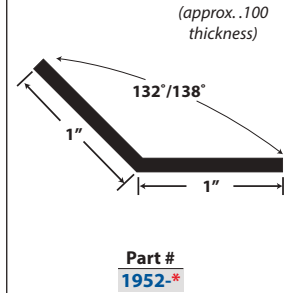
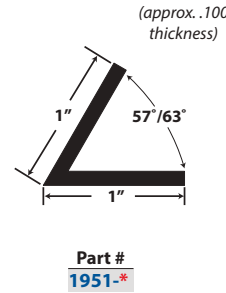
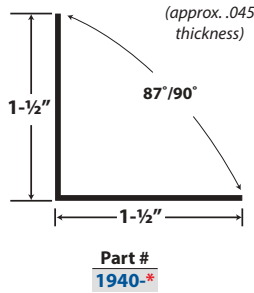
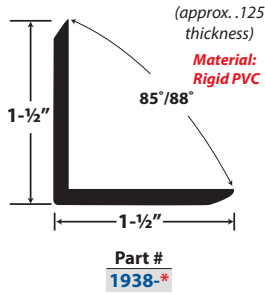
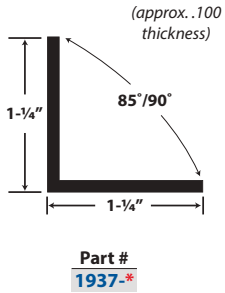
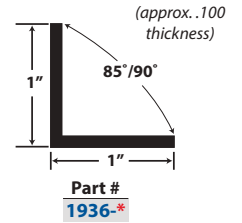
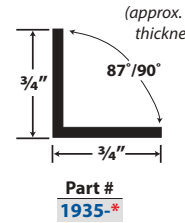
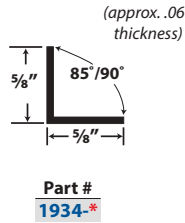
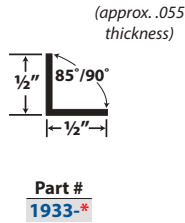
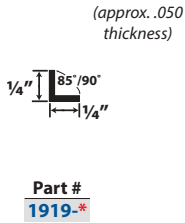
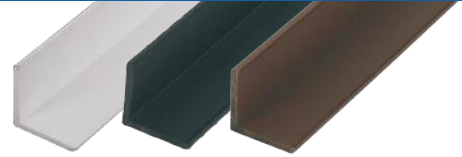

PLASTIC COLOR UNEVEN ANGLE MOULDING

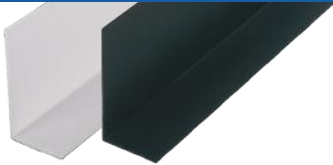

Lengths: 12 Ft.
Material: Styrene

Colors Available

*WH - White *BK - Black

Fits 5/16" x 7/16"
(approx. .050 thickness)

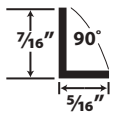

Fits 1/2" x 1"
(approx. .040 thickness)

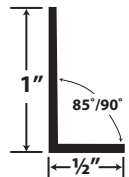

Fits 1-1/4" x 3/8"
(approx. .040 thickness)

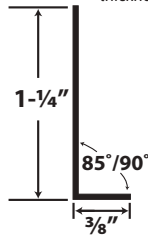

Fits 1" x 2"
(approx. .040 thickness)

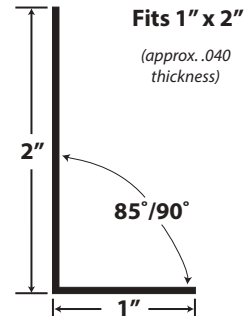

Fits 1" x 3"
(approx. .062 thickness)

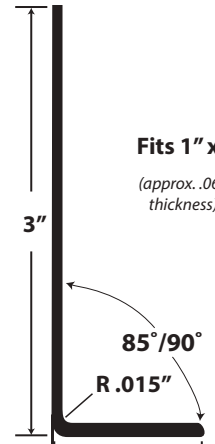

PLASTIC FLEXIBLE UNEVEN ANGLE MOULDING



Material: PVC • Black

Fits 1/2"

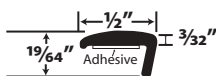

Fits 3/4"

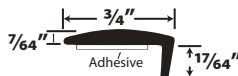

Fits 7/8"

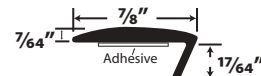

TRACK SYSTEMS FOR TAMBOUR DOORS



Recessed Mount Track System

Material: PVC, White or Brown

- Easy to cut desired lengths
- Track can be routed 3/8" deep x 9/16" wide groove or stapled directly to end panels
- All styles accept a maximum thickness of 7/32"

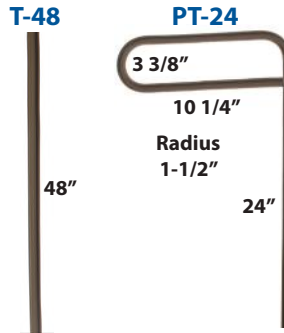
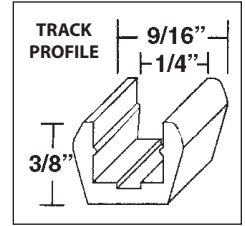

Part #	Color	Description
PT-24-BR	Brown	P Track
PT-24-WH	White	P Track
UT-24-BR	Brown	U Track
UT-24-WH	White	U Track
T-48-BR	Brown	Straight Track
T-48-WH	White	Straight Track

Plastic Tambour Track

Please Inquire for Tambour Wall Panels

INTERCHANGEABLE TRACK AND CURVES

(Check Your Door Thickness For Proper Track System)

APPLICATION
HORIZONTAL OR VERTICAL

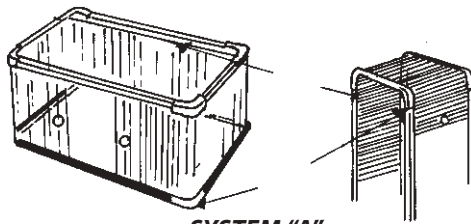

SYSTEM "A"
For Door Thickness 1/8"-3/16"
Stocked in Brown or Black

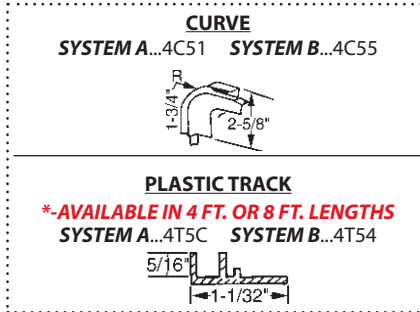

PLASTIC TRACK
*AVAILABLE IN 4 FT. OR 8 FT. LENGTHS
SYSTEM A...4T5C SYSTEM B...4T54

INSTALLATION

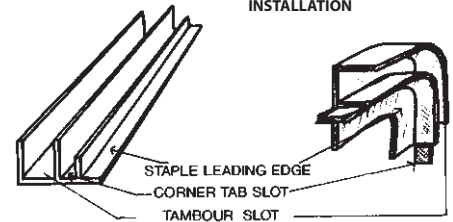

SYSTEM "B"
For Door Thickness 1/4"-5/16"
Brown Only

Part #	System "A" Description
4C51-BR	Brown tambour track curve for 1/8"-3/16" thick doors
4C51-BK	Black tambour track curve for 1/8"-3/16" thick doors
4T5C-BR*	Brown tambour door track for 1/8"-3/16" thick doors
4T5C-BK*	Black tambour door track for 1/8"-3/16" thick doors

Part #	System "B" Description
4C55-BR	Brown tambour track curve for 1/4"-5/16" thick doors
4T54-BR*	Brown tambour door track for 1/4"-5/16" thick doors

Flexible Tambour Track

FOR 1/4" DOOR THICKNESS • 8 FT. LONG

(Check Your Door Thickness For Proper Track System)

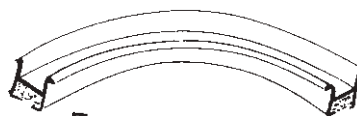

FLEXIBLE

10" Min. Radius

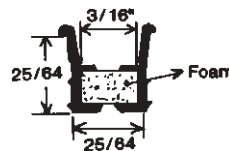

Part #	Color
FTT-BK	Black

ALUMINUM SLIDING DOOR TRACK

Lengths: 12 Ft.

Finishes Available

M - Mill - Dull Finish: As Extruded - May or May Not Have "Scratches"/Die Lines

Recommended for Glass or Wood Doors

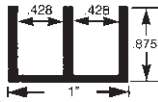
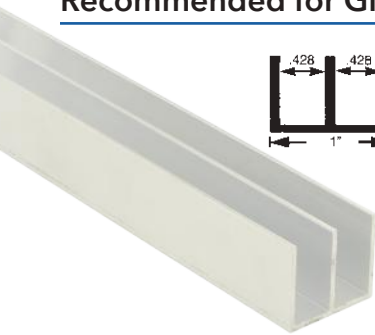

Part #
ALU7474-M

For Up to 1/4" Doors



.015 Thick
or less than 1/32"
(28 Gauge)

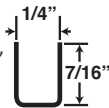

All Stainless Steel 430 Grade (Magnetic)
Polished-Shiny/Mirror Finish

Part #
SS907-P

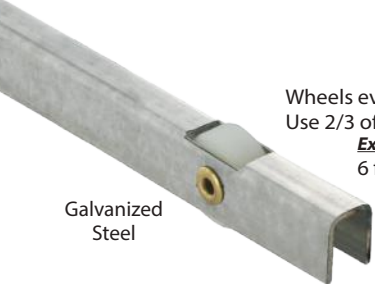

Wheels every 5-1/2".
Use 2/3 of the track with wheels.

Example:
6 ft. opening use 4 ft. of roller system.

Galvanized
Steel

Part #
ALURC4-12

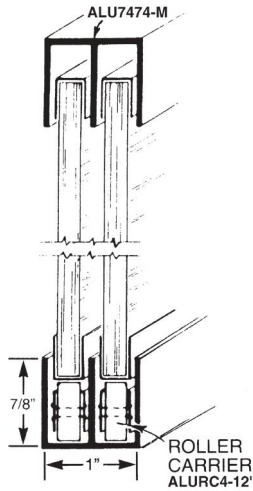

Recommended for Wood Doors

No Glides or Wheels Needed

Complete Set Consists Of:

- 1 Upper Track • 1 Lower Track

For 1/8" Doors

Part #
ALUT18-M

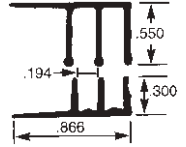

For 1/4" Doors

Part #
ALUT14-M

New! ALUT14-CL Clear Anodized - Dull, Matte Finish

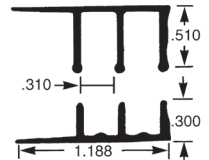

For 1/2" Doors

Part #
ALUT12-M

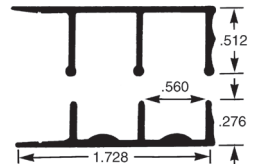

For 3/4" Doors

Part #
ALUT34-M

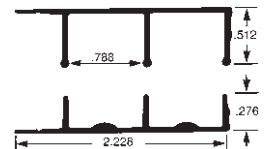

For 3/4" Doors

Part #
ALUT134SP-M

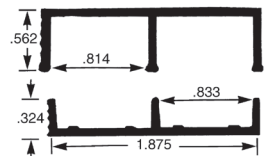

ULTRA PILE DUST SEAL / WEATHERSEAL W/ADHESIVE

Lengths: 50 Ft. Coils • Color: Gray

Self supporting pile is always on center
and has the integrity and consistency to
ensure a tight seal.



MANY
APPLICATIONS:
Windows
Doors
Showcases

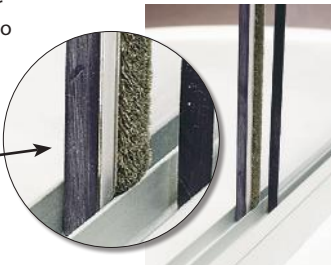

Part#	Description
DS-150-GY	.270 W x .150 H
DS-200-GY	.270 W x .200 H

PLASTIC SLIDING DOOR TRACK

Lengths: 12 Ft.
Material: Polypropylene

Colors Available

- *WH - White *BK - Black
 - *BR - Brown *AL - Almond
- unless otherwise noted*

Upper Track

For use with:

K101-606, K101-610, K101-601

Styrene

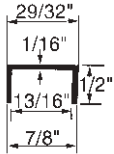

Part #
K101-4079*

Upper Track:
K101-4079

Locking Glide:
R26-62WH

Lower Single Flat Track

100 & 500 Ft. Coils

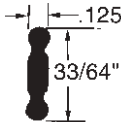

Part #
K101-601*



Locking Glide
R26-62

Natural Nylon White Locking Glides

For use with:

K101-606, K101-610, K101-601



1/4" x 1/4" x 1"

Nylon Glides Are Recessed Into the Door
Mounts onto 1/4" mortise on the bottom of each door with a brad nail.

Part #
R26-62WH

For Light Weight Doors

No Glides or Wheels Needed

Lengths: 12 Ft.
Material: Styrene
Colors Available

- *WH - White *BK - Black
- *BR - Brown *BE - Beige

Complete Set Consists Of:

- 1 Upper Track
- 1 Lower Track



For 1/8" Doors
* 5/32" gap

Part #
180*

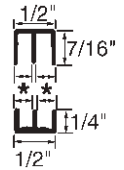

For 1/4" Doors
* 5/16" gap

Part #
140*

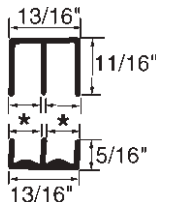

For 1/2" Doors
* 9/16" gap

Part #
120*

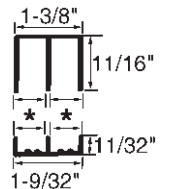

For 3/4" Doors

Part #
340*

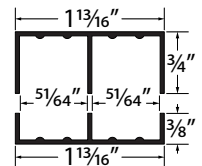

NOTE: ALL TRACK CAN BE MADE AVAILABLE WITH PRESSURE SENSITIVE TAPE. PLEASE INQUIRE.

PLASTIC MIRACLE TRACK

SLIDING DOOR TRACK SYSTEM WITH WHEELS

Material: Styrene • With or Without Adhesive

Colors Available

*BK - Black *SG - Silver Gray

For 1/4" Doors

High Quality **Easy-Roll** Metal Ball Bearings with **Economy** of Plastic Track

Complete Set Consists Of:

- 1 x 12 Ft. Length Upper Track
- 1 x 12 Ft. Length Lower Track
- 1 Wheel Per Running Ft.



With or Without Peel & Stick Adhesive

Without Adhesive - Available In 12 Ft. Lengths

Part #

MT38-*

With Adhesive - Available In 4 & 8 Ft. Lengths

Part #

Length

MT38-A4-*

4 ft.

MT38-A8-*

8 ft.

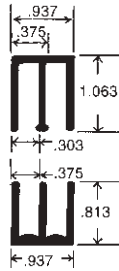

NOTE:
Rough Opening
Less 7/8" = Door Size



Additional Wheels

Part #

MTR

PLASTIC MIRACLE TRACK II

SLIDING DOOR TRACK SYSTEM WITH WHEELS

Lengths: 12 Ft. • Material: PVC • Silver Gray

For 1/4" Doors

- Lower track has sidewalls to prevent rollers from slipping off track
- 1" (25.4mm) shoe allows superior gripping of glass or plywood doors
- Deep upper track to allow extra clearance and easy installation
- Zinc plated rollers with plastic wheel
- Track & shoe material is rigid PVC

- OUR MOST POPULAR ASSEMBLY-

Complete Set Consists Of:

- 1 x 12 Ft. Length Upper Track
- 1 x 12 Ft. Length Lower Track
- 1 x 12 Ft. Length Shoe
- 1 Wheel Per Running Ft.

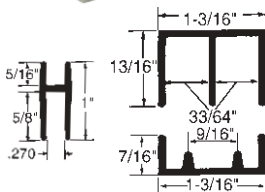
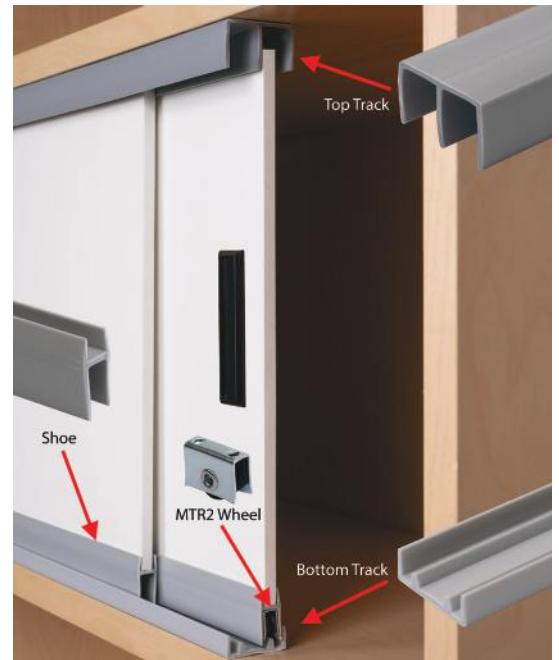

Additional Wheels

Part #

MTR2

Part #

MT39-SG

NOTE: ALL TRACK CAN BE MADE AVAILABLE WITH PRESSURE SENSITIVE TAPE. PLEASE INQUIRE.

PLASTIC FLAT BACK PRICE TAG COLOR MOULDINGS

Cut Program Available
PLEASE INQUIRE

Without Adhesive Backing
Lengths: 12 Ft. • Material: Styrene
Colors Available

*WH - White *BK - Black

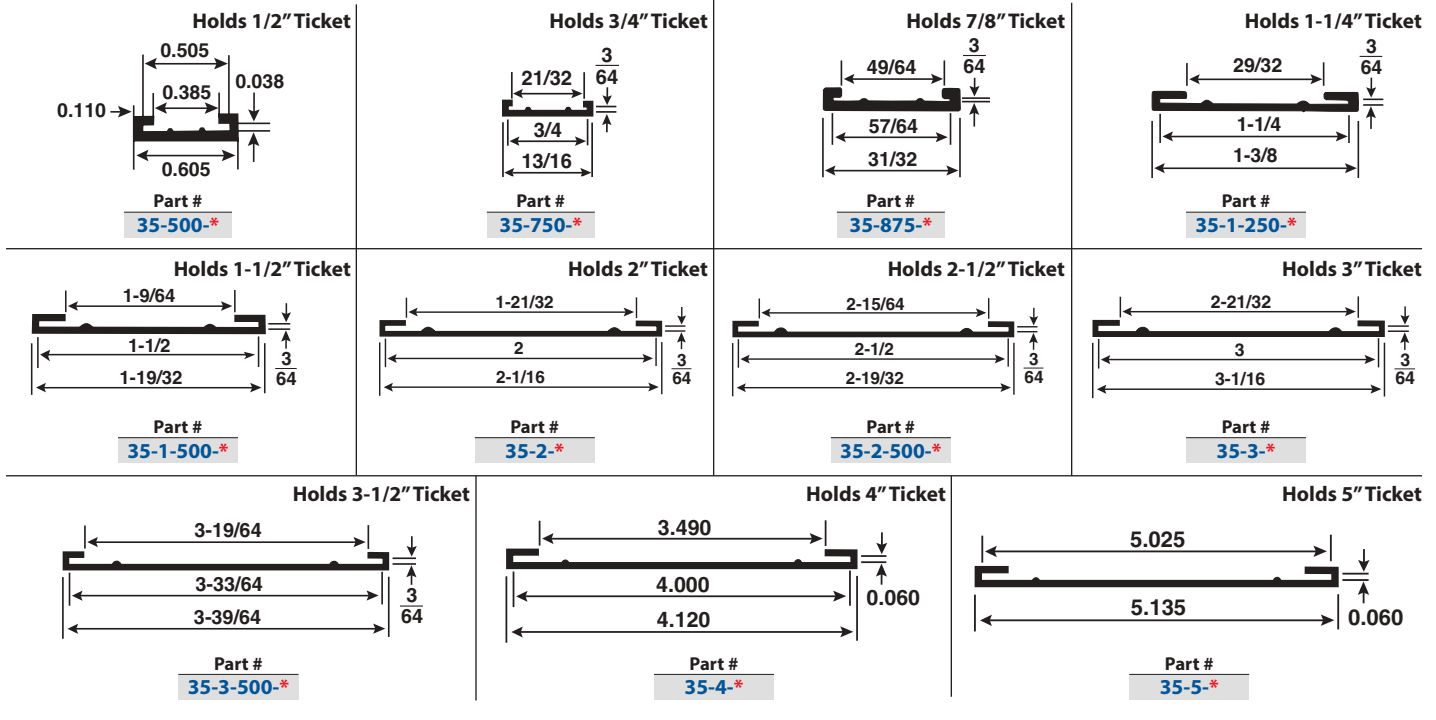

With Adhesive Backing
Lengths: 12 Ft. • Material: Styrene
Colors Available

*WH - White *BK - Black

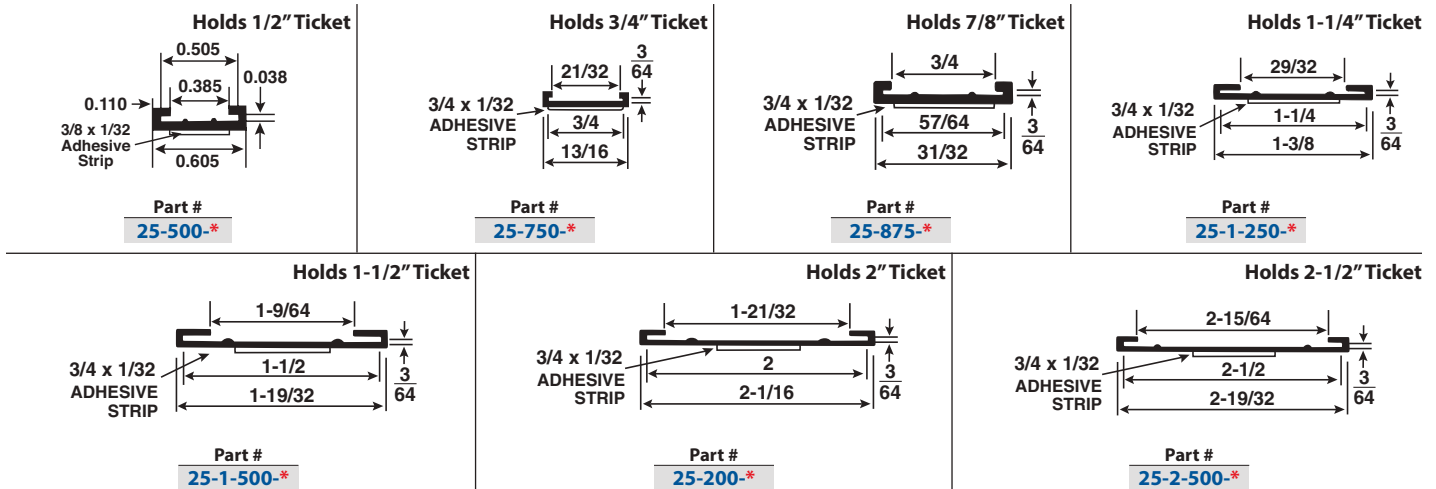

PROTOTYPE SAMPLES

We are happy to provide samples for prototypes & design builds - Please Inquire.

PLASTIC FLAT BACK PRICE TAG CLEAR MOULDINGS

Cut Program Available
PLEASE INQUIRE

Without Adhesive Backing
Lengths: 12 Ft. • Material: Butyrate • Clear

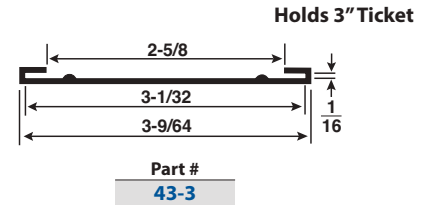
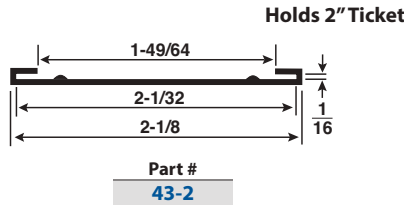
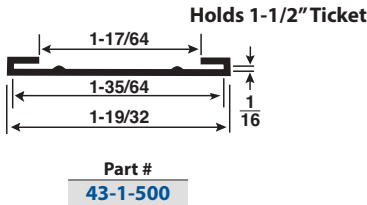
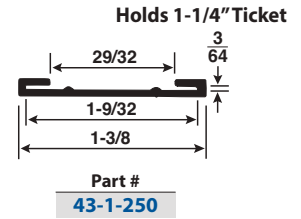
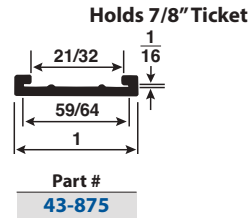
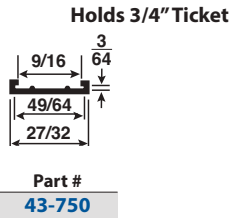
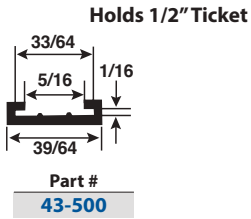

With Adhesive Backing
Lengths: 12 Ft. • Material: Butyrate • Clear

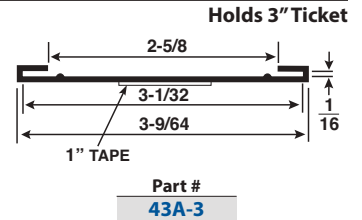
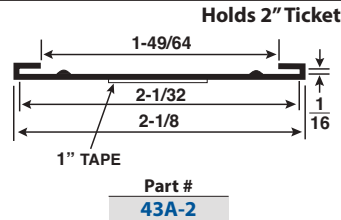
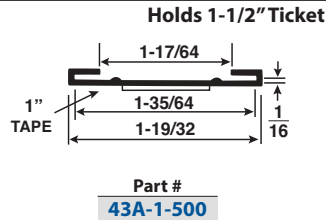
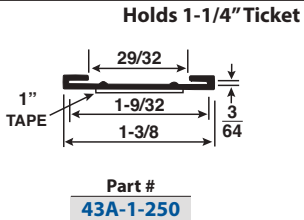
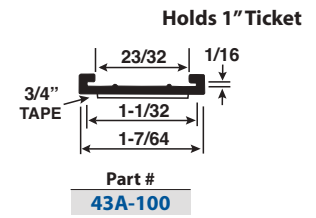
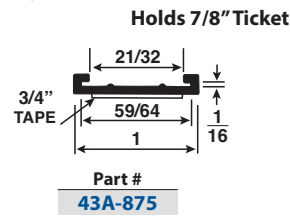
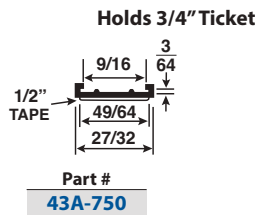
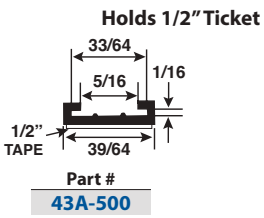

ALUMINUM PRICE TAG MOULDINGS W/HOLES

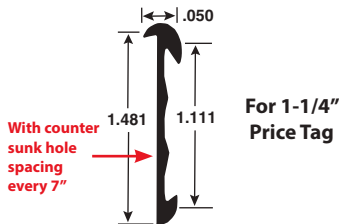

Part #	Length
ALU154-*	120 Ft. 600 Ft.+

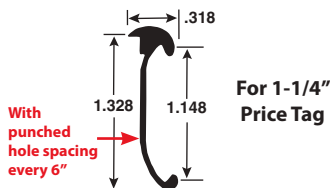

Part #	Length
ALU618-*	120 Ft. 600 Ft.+

Lengths: 12 Ft.
Finishes Available

- *P, PH (w/holes) - Polished/Mechanical - Shiny/Mirror Finish
- *BSH (w/holes) - Brushed Satin - Lightly Brushed (Shows Grain) Satin Finish
- *S, SH (w/holes) - Satin/Clear Anodized - Dull Matte Finish



Part #	Length
With Holes	
ALU157-*	120 Ft. 600 Ft.+
Without Holes	
ALU157NH-*	120 Ft. 600 Ft.+

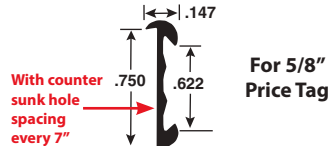

Part #	Length
With Holes	
ALU151-*	120 Ft. 600 Ft.+
Without Holes	
ALU151NH-*	120 Ft. 600 Ft.+

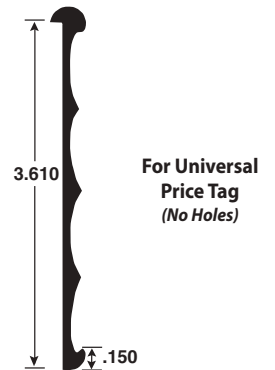

Part #	Length
ALU1316-*	120 Ft. 600 Ft.+

TICKET & LABEL HOLDERS

For Shelves & C Channels

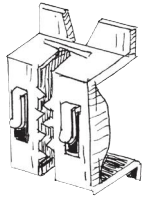

- Material: Durable White Polypropylene
- Fits 1-1/4" shelving channel
- Signage faces up, down or perpendicular for two-sided viewing

Part #
GTS-01

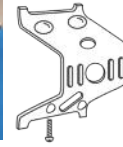

- Material: Steel
- Fits all standard gondola price channels
- Use locking screw **#MSC-SCREW** for extra strength

- Material: Steel
- Works with MSC-100



Part #
MSC-100 1" Wide Metal Adaptor Clip
MSC-SCREW Mounting Screw



- Material: PVC
- Lengths: 4 ft.
- White comes with a clear front
- Clips onto most 1-1/4" metal shelves
- Snaps into ticket moulding
- For Adhesive SKU card and non-adhesive 1-1/4" ticket

Fits 1-1/4" Ticket

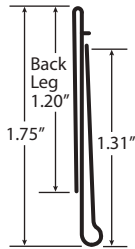

Part #
55-1251-WH White
55-1251-CL Clear

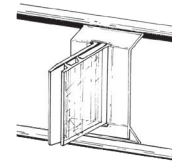

- Material: Clear PVC with Grip-Tite fingers
- Fits 7/8" to 1-1/4" shelving channel
- Signs display in the flag position
- Can be viewed from either aisle direction
- Holds sign stock to .080"

Part #
GTS-15



- Material: PVC
- Lengths: 4 ft.
- Available in Clear only
- Attaches to top of shelf with permanent film tape

Fits 1-1/4" Ticket

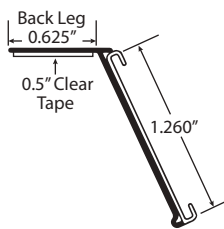

Part #
55-1265-CL Clear

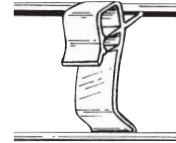

- Material: Clear PVC with Grip-Tite fingers
- Fits 1-1/4" shelving channel
- Signs display in the flat position
- Holds sign stock to .080"

Part #
GTS-14



- Material: Clear Styrolux
- Lengths: 8 ft.
- Snaps in to existing moulding
- Fits most shelf channels

Fits 1-1/4" Ticket

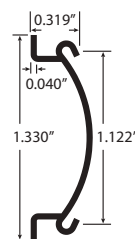

Part #
55-5952



- Material: Clear Styrolux with white foam tape
- Lengths: 8 ft.
- Used over shelf with built-in shelf guard
- Used under shelf for easy access
- Can be free standing without adhesive

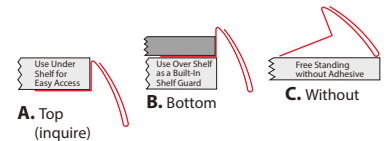

Part #
▲ **55-5957A**
■ **55-5957**

- ▲ With adhesive, can choose top or bottom
- Without adhesive

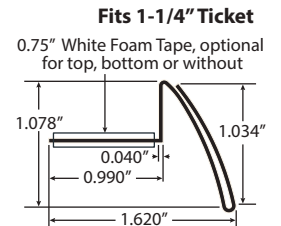

TICKET & LABEL HOLDERS

Flatback Tickets

With Clear Rubber Based Polyester Adhesive Tape for Permanent Installation *(unless otherwise noted)*

- **Butyrate Tickets:** Provides most clarity
- **Styrolux Tickets:** Provides more clarity than PVC, but more economical
- **PVC Tickets:** Most Economical

Colors Available

*CL - Clear *WH - White *BK - Black



Part #
6184-12

- Material: Clear Butyrate
- Lengths: 12 ft.
- Anti-Tampering
- White foam tape

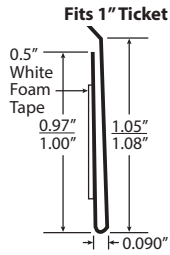

Part #
6186-12

- Material: Clear Butyrate
- Lengths: 12 ft.
- Anti-Tampering
- White foam tape

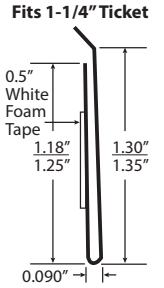

Part #
55-1260-*

- Material: PVC
- Lengths: 4 ft.
- White or Black come with a clear front
- Guide bar aids accurate installation

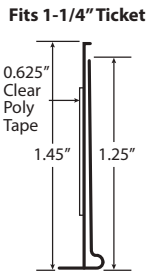

Part #
^55-5949
55-5949A

^ Without Adhesive

- Material: Clear Styrolux
- Lengths: 8 ft.
- Apply with adhesive or mechanical fastener

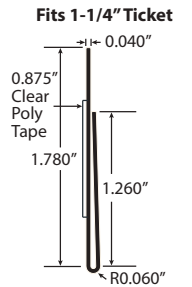

Part #
55-1250-*

- Material: PVC
- Lengths: 4 ft.
- Available in White or Black, with clear front
- Anti-Tampering

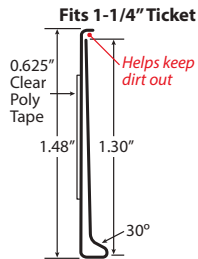

Part #
55-1550-*

- Material: PVC
- Lengths: 4 ft.
- Available in Clear or White, with clear front

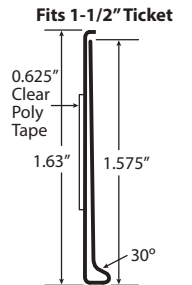

Part #
55-5948-CL

- Material: PVC
- Lengths: 8 ft.
- Anti-Tampering closed top

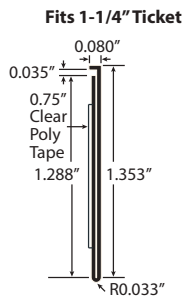

TICKET & LABEL HOLDERS

Tube Tickets

Cut Program Available
PLEASE INQUIRE



With Adhesive Backing
Material: Clear Butyrate • Lengths: 12 Ft.
Anti-Tampering

Holds 3/4" Ticket

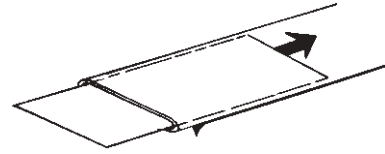
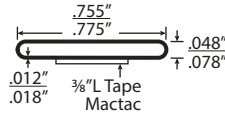

Part #
2051-CL

Dual For Price & Inventory Tickets



- Material: Clear PVC/Dual Durometer
- Lengths: 8 ft.
- 1-1/4" ticket with flip up front and white foam tape
- For Adhesive SKU card and non-adhesive 1-1/4" ticket



Part #
1125FT

For 1-1/4" Ticket

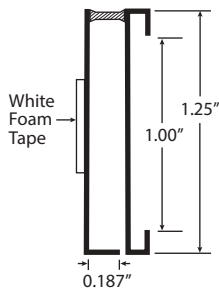

- Material: Clear Styrolux
- Lengths: 8 ft.
- With white foam tape
- Hinged
- For 2 non-adhesive cards
- Preferred for jewelry displays

Part #
55-5955

For 1-1/2" Ticket

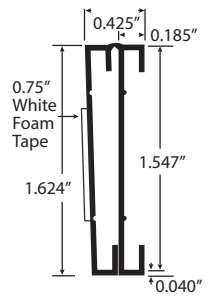

- Material: Clear PVC/Dual Durometer
- Lengths: 4 ft.
- Used as double ticket holder or clips in many fixtures
- Flex-hinged
- Mounted - No adhesive

Part #
55-1220

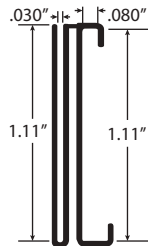

- Material: Styrene
- Lengths: 8 ft.
- Available in White or Black, with clear front
- Double ticket - Price tag and inventory tag can be seen at once

Part #	Color
55-5950-BK	Black
55-5950-WH	White

Dual 1-1/4" Tickets

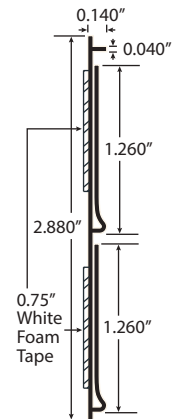

WAREHOUSE PRICE TAG

JOB TICKET/PRICE HOLDER*

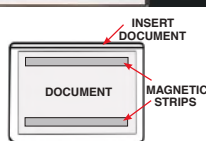
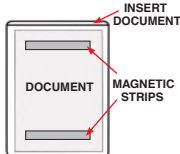

*Please Inquire for more information.

TICKET & LABEL HOLDERS

Snap-On Channel Mount Tickets



- Fits 3/16"-5/16" glass shelf
- Material: Clear Rigid PVC
- Lengths: 12 ft.
- Holds 1-1/4" H ticket

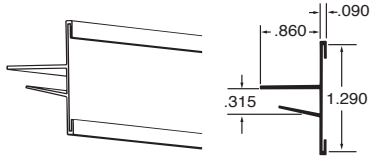

Part #
6165-12



- Fits 7/32"-1/4" glass shelf
- Material: Clear Butyrate
- Holds 3/8" H ticket

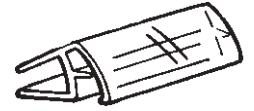

Part # **Length**
6105-03 3"



- Fits 7/32"-1/4" glass shelf
- Material: Clear Butyrate
- Holds 7/8" H ticket

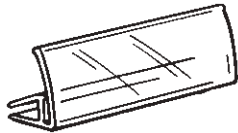

Part # **Length**
6121-03 2-7/8"



- Fits 7/32"-1/4" glass binning
- Material: Clear Butyrate
- Lengths: 2-7/8"
- Holds 7/8" H ticket



Part #
6119-03



- Fits 1/4" glass shelf
- Material: Clear Butyrate
- Lengths: 8 ft.
- Holds 1/2" ticket or rigid sign



Part #
52-CL



- Fits 1/4" glass shelf
- Material: Styrene
- Lengths: 12 ft.
- Holds 1" H ticket

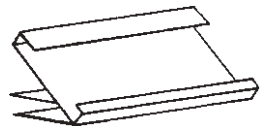

*Non-Stock item
Please Inquire*

Part # **Color**
40-WH White
40-BK Black



- Fits 3/4" metal shelf
- Material: Clear Butyrate
- Lengths: 2-7/8"
- Holds 7/8" H ticket

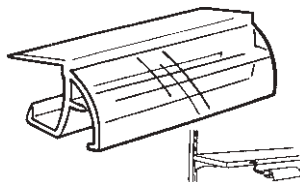

Part #
6136-03



- Fits 3/4"-7/8" shelf
- Material: Clear Rigid PVC
- Lengths: 12 ft.
- Holds 1-1/4" H ticket

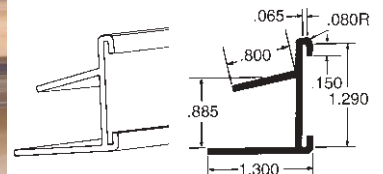

Part #
6135-12

TICKET & LABEL HOLDERS

Cut Program Available
PLEASE INQUIRE

Price Tag Holders For Wire



- Material: PVC
- Lengths: 4 ft.
- Snaps on to 1/4" wire

Fits 1-1/4" Ticket

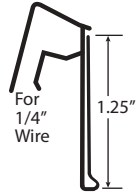

Part #	Length
55-1275-CL	4 ft.



- Material: PVC
- Runs to order
- Minimums and color match fees may apply, please inquire.
- Ideal for freezer cases

Fits 2" Ticket

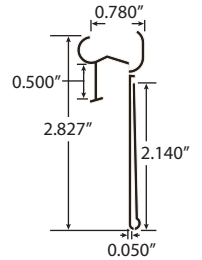

Part #
55-5962-WH



- Material: Clear Butyrate
- Work with 1/4" diameter wire
- Holds 1" H ticket

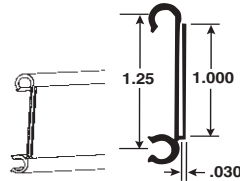

Part #	Size
6125-03	2-7/8" L

All Purpose Adhesive Clip

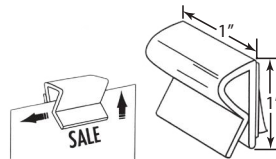

Material: White Styrene

- Easily works with wire up to 1/4" with its inside diameter of .300"
- Holds signage up to .187 thick
- Can work two ways: (1) over wire and apply signage to adhesive pad or (2) apply adhesive pad to flat surface
- Overall dimensions: 1"W x 1"L

Part #
APA-105

MERCHANDISING ESSENTIALS

Label Holders For Wire

UPC LOCKING STRAP LABEL HOLDER



- Material: Clear PVC
- Easily attaches to wire/grids up to 1/4" diameter
- Label area is 1-1/4" x 3" and is equipped with label setting guide rail

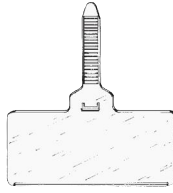

Part #
LH-3

SECURE-LOK LABEL HOLDER



- Material: Clear Polypropylene
- Easily attaches and locks on wire up to 3/8" diameter
- Label area: 1-1/4" x 3-1/2"

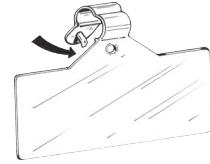

Part #
LH-4

Sign Holders For Wire

GRIP-TITE WIRE BASKET SIGN HOLDER



- Material: Clear PVC
- Fits wire up to 3/8" diameter
- Dual durometer ribs holds material up to 0.080" thick in flush mount position
- Overall dimensions: 1/2" x 1" L

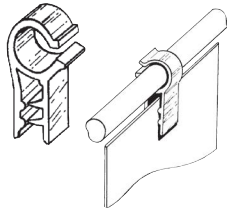

Part #
GTS-18

GRIP-TITE WIRE FLAG SIGN HOLDER



- Material: Clear PVC
- Fits wire up to approximately .200" (3/16") and has gripper ribs to hold securely
- Dual durometer ribs securely holds signage up to .080" thick
- Overall dimensions: 1" L x 11/16" W

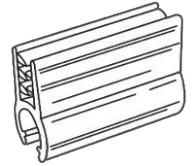

Part #
GTS-27

Bendable Sign Holders For Small Light Weight Signage

SPRING WOBLER



- Material: White Styrene bases (3/4" x 3/4")
- Metal Spring 1" long
- With adhesive on both vases sides this can be used virtually anywhere you can imagine
- Metal spring creates attention grabbing action

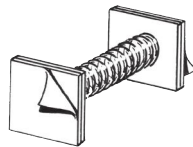

Part #
J2401

FLEXIBLE ALUMINUM SIGN HOLDERS

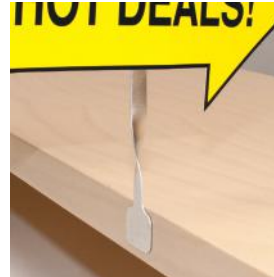

- Material: Aluminum
- With adhesive on both ends, this too can be just about anywhere you need
- Easily bends and adjusts to any shape you need

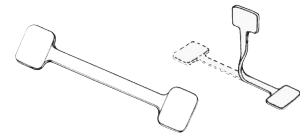

Part #	Length
FSH-33	3"
FSH-36	6"

TAPERED WOBLERS



- Material: Clear PVC
- With adhesive on both ends, this works on a variety of in store fixtures or displays
- Tapered body produces extra motion



Part #	Length
TW-60	6"
TW-80	8"

Power Panel Clip For Cardboard

- Material: White PVC
- Works with wire up to 1/4" diameter
- Holds 1/8" - "B" Flute corrugated signage material
- Overall dimensions: 1" W x 2" H

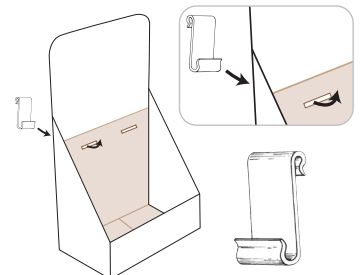

Part #
PPC-16

MERCHANDISING ESSENTIALS

Free Standing & Wall Mount Sign Holders

MOST CAN BE USED IN HORIZONTAL AND VERTICAL APPLICATIONS

STRAIGHT CENTER MOUNT SIGN/CARD HOLDER



- Material: Clear Styrene
- Holds material up to 1/32" thick
- 1-1/2" W x 1-3/4" L base with 1/4" H secure grip sign holder

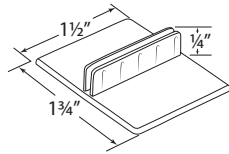

Part #	Length
SCH-1	1-3/4"

ANGLED TABLETOP SIGN HOLDER

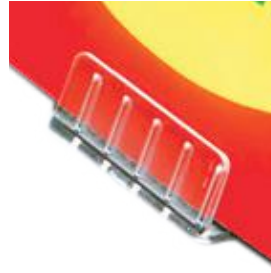

- Material: Clear Styrene
- Holds material up to 1/32" thick
- 1-9/16" L x 2-3/8" base with 7/16" H slanted sign holder

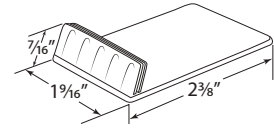

Part #	Length
ACH	1-9/16"

COUNTER TOP SIGN HOLDERS



- Material: Clear Rigid PVC
- Holds material up to 1/8" thick
- Peel and stick adhesive on 1" back
- 1" W x 3" or 6" L base x 3/4" H tension grip sign holder

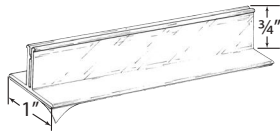

Part #	Length
GTS-77-3	3"
GTS-77-6	6"

STRAIGHT CENTER MOUNT SIGN HOLDER



- Material: White Styrene
- Holds material .060 to .070 thick
- Peel and stick foam back
- 1-1/8" L x 1/2" W base x 7/16" H secure grip sign holder

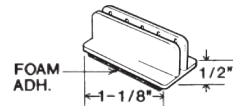

Part #	Length
J2223-3D	1-1/8"

PRICE CHANNEL SIGN HOLDER



- Material: Clear PVC
- Holds material up to .080" thick
- Peel and stick foam back
- 1/2" W x 1" or 3" L base x 7/16" H sign holder w/grip-tite fingers to hold card stock securely

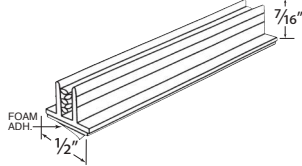

Part #	Length
GTS-16-1	1"
GTS-16-3	3"

GRIP-TITE CHANNEL STRIP SIGN HOLDER

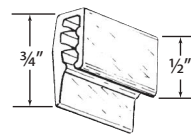

- Material: Clear PVC
- Holds material up to 0.080" thick
- Peel and stick foam back
- 1" or 3" L x 3/4" H mounting base x 1/2" H sign holder w/ grip-tite fingers to hold signs in flush mount position

Part #	Length
GTS-17-1	1"
GTS-17-3	3"

PRICE CHANNEL SIGN HOLDER

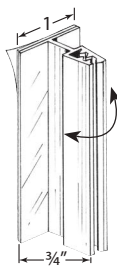

- Material: Clear PVC
- Holds material up to .060" thick
- Peel and stick foam back
- 1" W x 3" or 6" L base x 3/4" H sign holder w/grip-tite fingers and built-in moving flexibility for high traffic areas where signs get hit

Part #	Length
GTS-20-3	3"
GTS-20-6	6"

GRIP-TITE CHANNEL STRIP SIGN HOLDER



- Material: Clear PVC
- Holds material up to 0.080" thick
- Peel and stick foam back
- Wide base for extra stability
- 1" W x 1" or 3" L base x 7/16" H sign holder w/grip-tite fingers to hold card stick securely

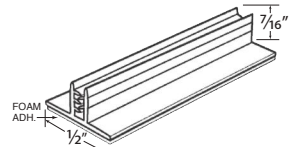

Part #	Length
GTS-25-1	1"
GTS-25-3	3"

MERCHANDISING ESSENTIALS

Free Standing & Wall Mount Sign Holders

MOST CAN BE USED IN HORIZONTAL AND VERTICAL APPLICATIONS

SPECIALTY SIGN HOLDER



- Material: Clear Butyrate
- Holds material up to 0.100" thick
- 1/2" H tension grip sign holder w/ 1-1/4" L x 1" deep curved mounting base to work w/shelving and showcases

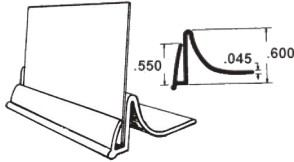

Part #	Length
6201-01	1-1/4"

SIGN CHANNEL PVC/DUAL DUROMETER



- Material: PVC
- Lengths: 8 ft.
- Holds material 1/8" thick
- Peel and stick foam back
- 1/2"W base x 7/16" H with dual durometer grip

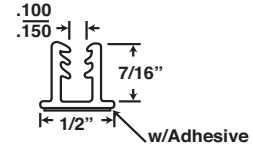

Part #	Color
106-4808-BK	Black
106-4808-WH	White

FREE STANDING CARD HOLDER



- Material: White Styrene
- Lengths: 12 ft.
- Fits material 1/16"-1/4" thick
- 2"W flat base x 1"H

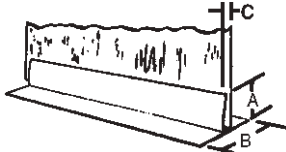

Part #	A	B	Fits Card
24-WH	1"	2"	1/16"-1/4"

SIGN HOLDER / DUAL DUROMETER



- Material: Clear PVC
- Lengths: 3 in. 6 in. & 8 ft.
- Fits 1/8" - 1/4" thick signs
- Peel and stick foam back
- 1"W base x 11/16" H with dual durometer grip

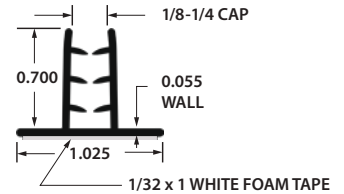

Part #	Length
GTS-140-3	3 in.
GTS-140-6	6 in.
106-4814-CL	8 ft.

CLEAR/PVC



- Material: Clear PVC
- Lengths: 12 ft.
- Holds material up to .060" thick
- 1-1/2"W base x 3/4"H

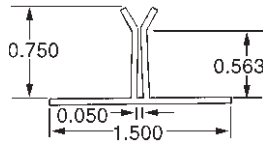

Part #
1255-CL

SIGN HOLDER / DUAL DUROMETER



- Material: Clear Rigid PVC
- Lengths: 8 ft.
- Fits 1/8" - 1/4" thick signs
- Peel and stick foam back
- 3/4"W base x 11/16" H with dual durometer grip

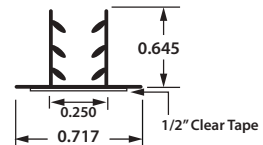

Part #	Length
106-4820-CL	8 ft.

SIGN / BANNER HOLDERS

- An easy & affordable way to emphasize brands & your marketing message.
- Channels can easily be cut-to-size to accommodate a variety of banner widths.
- All channels can be used as a top & bottom rail.



142F-

- Material: Styrolux
- Flared legs for easy graphic insertion

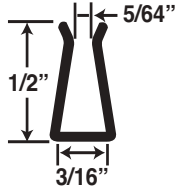

Part #	Color	Length
142F-CL	Clear	12'
142F-BK	Black	12'
142F-WH	White	12'



670-A-

- Material: Styrolux
- Classic universal clip design

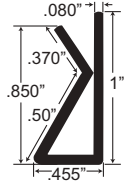

Part #	Color	Length
670-A-BK	Black	8'
670-A-WH	White	8'



HS-447- "Super Clamp"

- Material: PVC
- Each 4' length piece comes with 6 hanging hardware (BH-788-H) to hang banner onto the wall or from the ceiling.

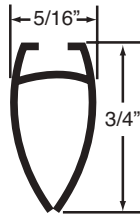

Part #	Color	Length
HS-447-CL	Clear	4'
HS-447-BK	Black	4'
HS-447-WH	White	4'



130- "Banner Clamp"

- Material: Clear PVC or Black & White Styrene

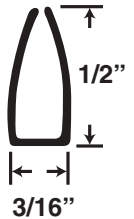

Part #	Color	*Length
130-CL-*	Clear	(*8) = 8 ft.
130-BK-*	Black	(*10) = 10 ft.
130-WH-*	White	



131- "Clamp It"

- Material: Clear PVC or Black & White Styrene

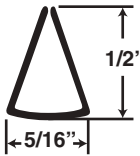

Part #	Color	*Length
131-CL-*	Clear	(*8) = 8 ft.
131-BK-*	Black	(*10) = 10 ft.
131-WH-*	White	



2326- "Banner Channel"

- Material: Black ABS with high gloss film on the front of the profile

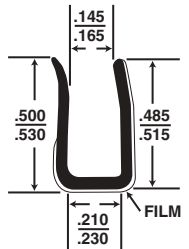

Part #	Color	Length
2326-BK	Black	12'

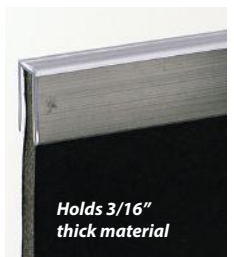

1059- "Banner Channel"

- Material: Rigid PVC

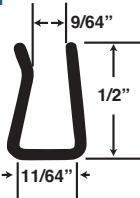

Part #	Color	Length
1059-CL	Clear	12'



HS-2010- "The Great Gripper"

- Material: PVC
- Each 8' length piece comes with 4 hanging hardware (BH-788-H) to hang banner onto the wall or from the ceiling.

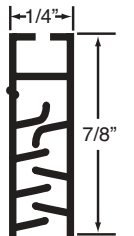

Part #	Color	Length
HS-2010-CL	Clear	8'

SIGN / BANNER HOLDERS

- An easy & affordable way to emphasize brands & your marketing message.
- Channels can easily be cut-to-size to accommodate a variety of banner widths.
- All channels can be used as a top & bottom rail.

PFLF-1200-



Holds up to 1/8" thick material

- Material: Dual Durometer PVC
- With or without adhesive

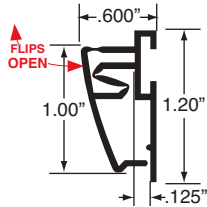

Part #	Color	Length
PFLF-1200-BK	Black	12'
PFLF-1200-SL	Silver	12'
PFLF-1200-WH	White	12'
with Adhesive		
PFLF-1200A-BK	Black	12'
PFLF-1200A-SL	Silver	12'

PFLF-1040-



Holds up to 1/16" thick material

- Material: Dual Durometer PVC
- With or without adhesive

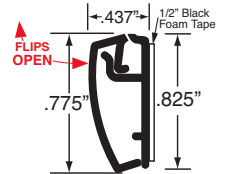

Part #	Color	Length
PFLF-1040-BK	Black	12'
PFLF-1040-SL	Silver	12'
PFLF-1040-WH	White	12'
with Adhesive		
PFLF-1040A-BK	Black	12'
PFLF-1040A-SL	Silver	12'
PFLF-1040A-WH	White	12'

BH-788- "Banner Holder" w/Snap Action



Holds up to 1/8" thick material

- Material: Styrene
- Contoured shape allows for 2 sided graphics
- Easy mount channel for hanging hardware (BH-788-H), hang banner onto the wall or from the ceiling.

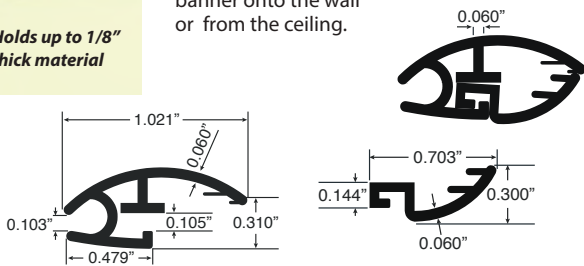

Part #	Color	Length
BH-788-BK	Black	8'
BH-788-WH	White	8'

2799- "Mini Snap"



Holds up to 1/16" thick material

- Material: Rigid PVC

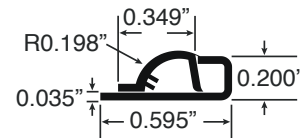

Part #	Color	Length
2799-BK	Black	8'
2799-WH	White	8'

BH-788-H- "Universal Hanger"



Fits into channels up to 1/4" wide

- Material: Clear Polyethylene
- Easily slides into the BH-788- "Banner Holder", HS-2010-CL "The Great Gripper" and HS-447- "Mini Snap".

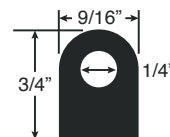

Part #	Color
BH-788-H	Clear

FULLY ASSEMBLED, FRONT LOADING ALUMINUM FRAMES

ATTRACTIVE AND EASY-TO-USE!

Built-in spring loaded hinge enables you to change graphics in a snap without disassembling the frame.

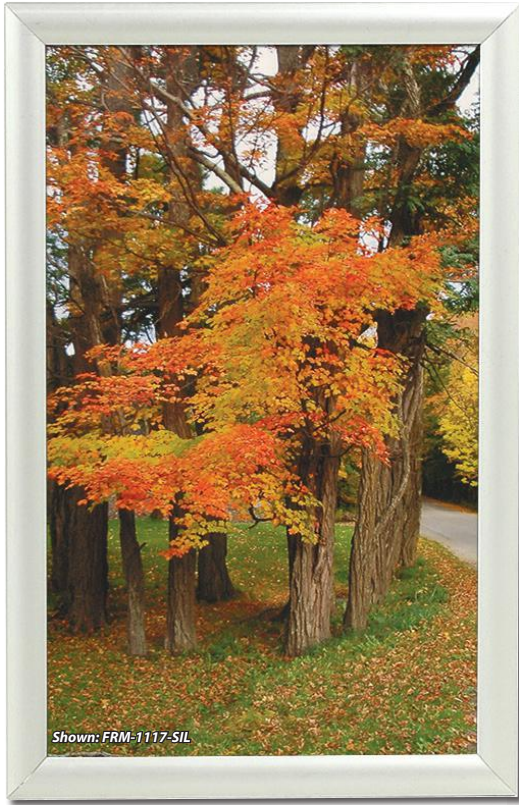

- Fully assembled frame comes with clear non-glare lens and back panel
- Strong aluminum construction
- Snap/Spring loaded
- Screw holes on the back for easy mounting - portrait or landscape
- Screws and drywall anchors are included
- Custom sizes and finishes available at a minimum. Please inquire for more details.

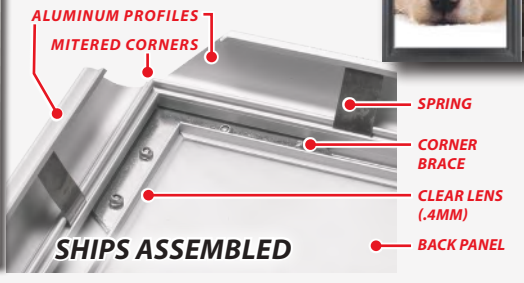
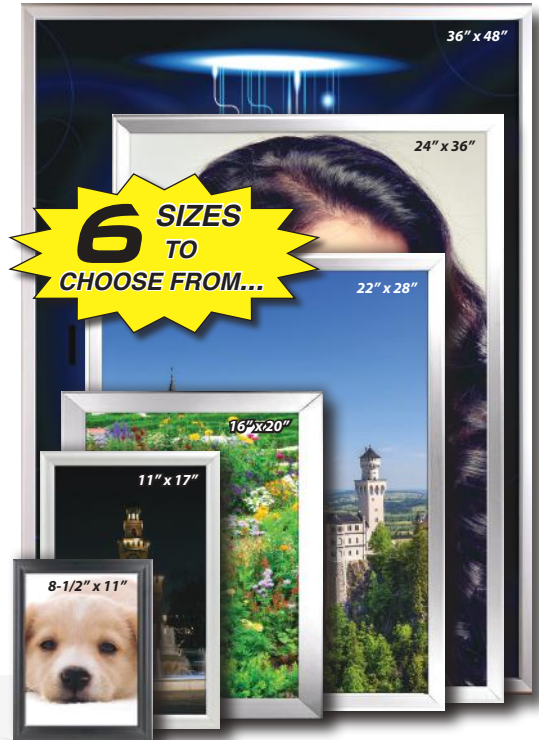

...AN ARRAY OF STYLES!

1" Frame With Clear Anodized Or Black Powder Coat Finish

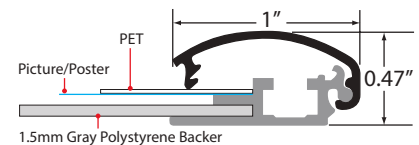
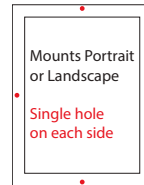
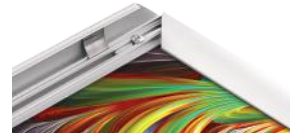

Part #	Graphic Size	Reveal Dimensions	Overall Dimensions	Finish
FRM-8511-SIL	8-1/2" x 11"	7-5/8" x 10-1/8"	9-11/16" x 12-3/16"	Clear Anodized
FRM-8511-BK	8-1/2" x 11"	7-5/8" x 10-1/8"	9-11/16" x 12-3/16"	Black Powder Coat
FRM-1117-SIL	11" x 17"	10-1/4" x 16-3/16"	12-1/4" x 18-3/16"	Clear Anodized
FRM-1117-BK	11" x 17"	10-1/4" x 16-3/16"	12-1/4" x 18-3/16"	Black Powder Coat
FRM-1620-SIL	16" x 20"	15-1/8" x 19-1/8"	17-3/16" x 21-3/16"	Clear Anodized
FRM-1620-BK	16" x 20"	15-1/8" x 19-1/8"	17-3/16" x 21-3/16"	Black Powder Coat
FRM-2228-SIL	22" x 28"	21-5/8" x 27-11/16"	24-1/8" x 30-1/8"	Clear Anodized
FRM-2436-SIL	24" x 36"	23-1/2" x 35-5/8"	26-1/8" x 38-1/8"	Clear Anodized

Custom sizes & finishes can be produced. Please Inquire.

To view our full line of Fully Assembled, Front Loading Aluminum Frames, visit www.outwater.com

ALUMINUM FRAME PROFILES

"SNAP-EASE" FRONT LOADING FRAME PROFILES

MAKE YOUR OWN FRAMES WITH OUR COMPONENTS!

7
FINISHES

- Stocked in 8 ft. lengths for  shipping
- Each profile includes base and cap



CREATE
CUSTOM FRAMES!

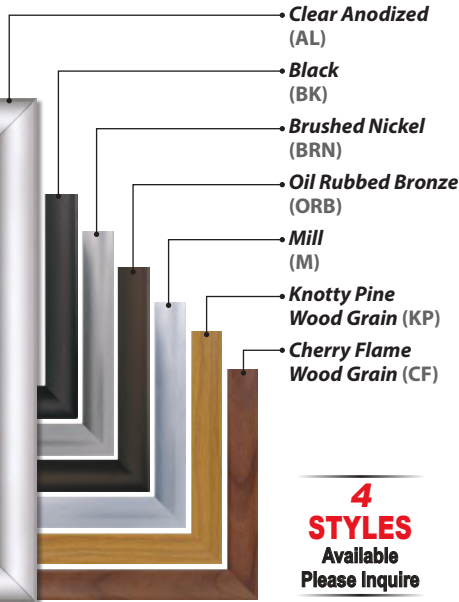

4
STYLES
Available
Please Inquire

SHOWN ASSEMBLED

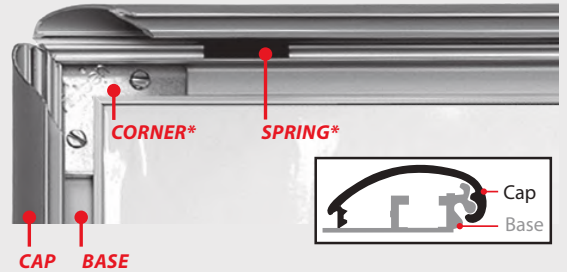

*CORNER: Joins mitered profiles. 4 required to assemble frame.

*SPRING: Allows frame to open and snap-close.

Requires minimum 2 per 10" and 1 every additional 4-6".

Example: 22" x 28" frame = [4] [5] springs

*Corners and Springs sold separately

FLF-8-

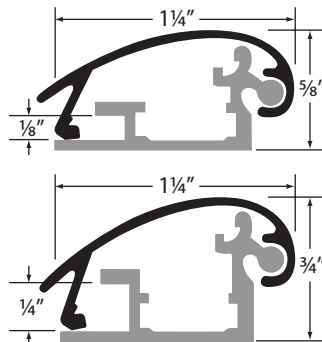
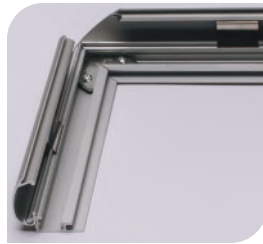

REQUIRED ACCESSORIES



FLF-CORNER
joins mitered profiles
(Requires 4 per frame)

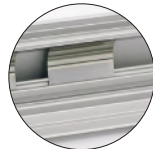

FLF-SPRING
to open/close frame
(min. 2 per 10")

FOR 1/8" INSERT

With Matching Base & Cap Finish

Part #	Base & Cap Finish
FLF-8-AL	Clear Anodized
FLF-8-BK	Black Matte
FLF-8-BRN	Brushed Nickel
FLF-8-ORB	Oil Rubbed Bronze
FLF-8-KP	Knotty Pine Wood Grain
FLF-8-CF	Cherry Flame Wood
FLF-8-M	Mill

With Mill Base & Finished Cap

Part #	Cap Finish
FLF-8M-AL	Clear Anodized
FLF-8M-BK	Black Matte
FLF-8M-BRN	Brushed Nickel
FLF-8M-ORB	Oil Rubbed Bronze
FLF-8M-KP	Knotty Pine Wood Grain
FLF-8M-CF	Cherry Flame Wood

FOR 1/4" INSERT

With Mill Base & Finished Cap

Part #	Cap Finish
FLF-8QM-AL	Clear Anodized
FLF-8QM-BK	Black Matte
FLF-8QM-BRN	Brushed Nickel
FLF-8QM-ORB	Oil Rubbed Bronze
FLF-8QM-KP	Knotty Pine Wood Grain
FLF-8QM-CF	Cherry Flame Wood
FLF-8Q-M	Mill

To view our full line of "Snap-Ease" Front Loading Frames, visit www.outwater.com

SIGN / BANNER HOLDERS

THE "SNAP-EASE" ALUMINUM BANNER HANGING SYSTEM

CLEAR ANODIZED ALUMINUM
24", 36", 48" & 96" LENGTHS

NOTE: ALL LENGTHS ARE NOMINAL

**ADDS
STYLE & VALUE**

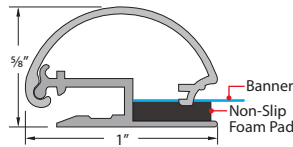
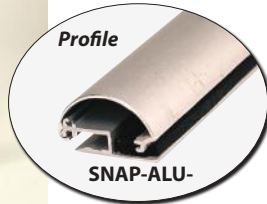

- Clear anodized aluminum finish with 4 black plastic end caps for a "finished" look.
- The spring clips inside the rail will "snap" close to securely hold your banner in place.
- Ideal for paper, fabric and vinyl banners up to .08" thick.
- Recommend to be used at the bottom of your banner for added stability.
- Includes removable hanging clips. The banner hanging system can be attached to the wall or hung from the ceiling.

Part #	Length
SNAP-24	24"
SNAP-36	36"
SNAP-48	48"
SNAP-96	96"

Components To Complete Your Customization

Hanging Clips



SNAP-HC

End Caps



SNAP-EC

Spring Clips



SNAP-SC

4" Joiner Bar



HGR-JOIN

Material: Aluminum
Finish: Mill

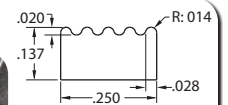

SNAP EASE SIGN KITS

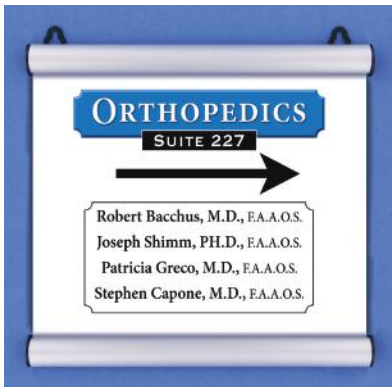

- Vertical or Horizontal mounting
- All inclusive kits:
 - 2 length banner holders
 - 2 hanging clips
 - 4 end caps
 - 2 spring clips

Part #	Length
SNAP-KIT-8	8-1/2"
SNAP-KIT-11	11"



EASY FASTEN STANDOFFS



Eco Lite Series



MATERIAL = 202 Stainless Steel
FINISH = Brushed Stainless (BSS)

- 2 Part Assembly
- Lightweight construction
- #6 flat head screws and drywall anchors included

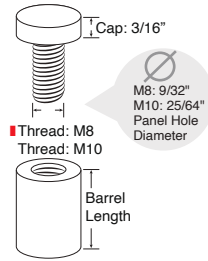

Finish:
 (BSS)
 Brushed
 Stainless

Selected part #'s only have Thread: M8



Part #	Panel Thickness	Barrel Length	Thread Length	Diameter
STDE-1313-BSS	Up to 1/4"	1/2"	1/2"	1/2"
STDE-1324-BSS	Up to 1/2"	3/4"	3/4"	1/2"
STDE-1332-BSS	Up to 1/2"	1"	3/4"	1/2"
STDE-1348-BSS	Up to 1/2"	1-1/2"	3/4"	1/2"
STDE-1364-BSS	Up to 1/2"	2"	3/4"	1/2"
STDE-1396-BSS	Up to 1/2"	3"	3/4"	1/2"
STDE-13128-BSS	Up to 1/2"	4"	3/4"	1/2"
STDE-2024-BSS	Up to 1/2"	3/4"	3/4"	5/8"
STDE-2032-BSS	Up to 1/2"	1"	3/4"	5/8"
STDE-2048-BSS	Up to 1/2"	1-1/2"	3/4"	5/8"
STDE-2064-BSS	Up to 1/2"	2"	3/4"	5/8"
STDE-2096-BSS	Up to 1/2"	3"	3/4"	5/8"
STDE-20128-BSS	Up to 1/2"	4"	3/4"	5/8"
STDE-2424-BSS	Up to 1/2"	3/4"	3/4"	3/4"
STDE-2432-BSS	Up to 1/2"	1"	3/4"	3/4"
STDE-2448-BSS	Up to 1/2"	1-1/2"	3/4"	3/4"
STDE-2464-BSS	Up to 1/2"	2"	3/4"	3/4"
STDE-2496-BSS	Up to 1/2"	3"	3/4"	3/4"
STDE-24128-BSS	Up to 1/2"	4"	3/4"	3/4"

Part #	Panel Thickness	Barrel Length	Thread Length	Diameter
STDE-3224-BSS	Up to 1/2"	3/4"	3/4"	1"
STDE-3232-BSS	Up to 1/2"	1"	3/4"	1"
STDE-3248-BSS	Up to 1/2"	1-1/2"	3/4"	1"
STDE-3264-BSS	Up to 1/2"	2"	3/4"	1"
STDE-3280-BSS	Up to 1/2"	2-1/2"	3/4"	1"
STDE-3296-BSS	Up to 1/2"	3"	3/4"	1"
STDE-32112-BSS	Up to 1/2"	3-1/2"	3/4"	1"
STDE-32128-BSS	Up to 1/2"	4"	3/4"	1"
STDE-32192-BSS	Up to 1/2"	6"	3/4"	1"
STDE-4024-BSS	Up to 1/2"	3/4"	3/4"	1-1/4"
STDE-4032-BSS	Up to 1/2"	1"	3/4"	1-1/4"
STDE-4048-BSS	Up to 1/2"	1-1/2"	3/4"	1-1/4"
STDE-4064-BSS	Up to 1/2"	2"	3/4"	1-1/4"
STDE-4096-BSS	Up to 1/2"	3"	3/4"	1-1/4"
STDE-40128-BSS	Up to 1/2"	4"	3/4"	1-1/4"
STDE-40192-BSS	Up to 1/2"	6"	3/4"	1-1/4"
STDE-4824-BSS	Up to 1/2"	3/4"	3/4"	1-1/2"
STDE-4832-BSS	Up to 1/2"	1"	3/4"	1-1/2"
STDE-4848-BSS	Up to 1/2"	1-1/2"	3/4"	1-1/2"
STDE-4864-BSS	Up to 1/2"	2"	3/4"	1-1/2"
STDE-4896-BSS	Up to 1/2"	3"	3/4"	1-1/2"
STDE-48128-BSS	Up to 1/2"	4"	3/4"	1-1/2"
STDE-48192-BSS	Up to 1/2"	6"	3/4"	1-1/2"

Clear Acrylic Transparent Standoffs

MATERIAL = Acrylic
FINISH = Clear (CL)

- 2 Part Assembly
- Lightweight, durable construction
- Transparent acrylic
- #6 flat head screws and drywall anchors included

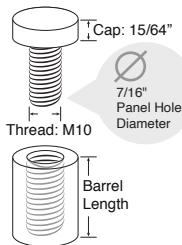

Part #	Panel Thickness	Barrel Length	Thread Length	Diameter
STDY-2424-CL	Up to 5/16"	3/4"	5/8"	3/4"
STDY-2432-CL	Up to 1/2"	1"	7/8"	3/4"
STDY-3232-CL	Up to 1/2"	1"	7/8"	1"



Picture & Art Hanging Systems

Our hanging systems allows you to easily add, reposition/remove art or wall objects without wall damage.

- Hanging & display solutions for residential & commercial use
- Easy to adjust and change artwork
- Eliminates wall repairs and repainting
- No tools needed
- Aluminum track load capacity: 110 lbs. per length
- Nylon cable load capacity: 33 lbs. per length
- Stainless cable load capacity: 44 lbs. per length

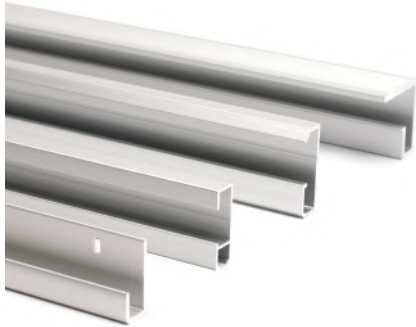

1 Select Your Channel



2 Select Your Vertical Cables



3 Select Your Picture Hooks

New! Click Track

Versatile • Discreet • Easy to Install

The Click Track is secured to the wall using click buttons that conceal all fittings and wall anchors

Secure Click Buttons to Wall



Track Attaches to Click Buttons

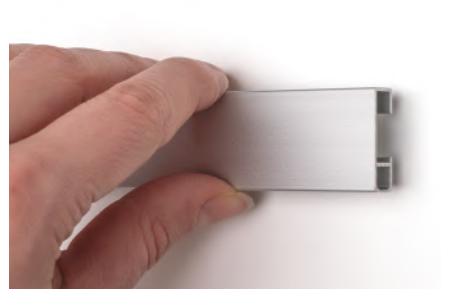

Slide Fitting in to Track & Install End Cap



WALL TRACK IN 2MM CABLE FOR ART

Channels For Cables With Top Hooks

1. Click Track

GPX-TK100-*

Finish: Black (*BK),
White (*WH) & Satin (*S)

Cable Diameter: 2mm

Length: 6'



Included:
2 End Caps,
3 Click Buttons
& 1 Splicer

2. Wall Track

GPX-TK101-*

Finish: Black (*BK),
White (*WH) & Satin (*S)

Cable Diameter: 2mm

Length: 6'



3. Ceiling Track

GPX-TK102-*

Finish: Black (*BK),
White (*WH) & Satin (*S)

Cable Diameter: 2mm

Length: 6'



4. J Track

ALU851-*

Finish: Black (*BK),
White (*WH), Satin (*S),
Mill (*M) & Polished (*P)

Cable Diameter: 2mm

Length: 12'



Holes
Approx.
4" Spacing

Part #	Mill (*M)	Polished (*P)	Satin (*S)	Black (*BK)	White (*WH)
ALU851-*	-	-	-	-	-

Accessories

Hex Keys

CSK-HEX



Cable Cutter

CSK-CUTTER



Large Picture Stabilizer

Recommended for pictures
16" x 16" and up

GPX-HK13-NP



Vertical Cables

1



2



3



4



5



Part #	Description	Cable Material	Length	Carton Qty.
1 GPX-T48-N	T-End Cable	Nylon	48"	50
1 GPX-T120-N	T-End Cable	Nylon	120"	50
1 GPX-T48-SS	T-End Cable <i>Work With Track: GPX-TK100-*</i>	Stainless	48"	50
1 GPX-T120-SS	T-End Cable	Steel	120"	50
2 GPX-B48-SS	Ball End Cable	Stainless	48"	50
2 GPX-B120-SS	Ball End Cable <i>Work With Track: GPX-TK100-*</i>	Steel	120"	50
3 GPX-V48-SS	V-End Cable	Stainless	48"	50
3 GPX-V120-SS	V-End Cable <i>Work With Track: ALU851-*</i>	Steel	120"	50
4 GPX-P48-N	P-End Cable	Nylon	48"	50
4 GPX-P120-N	P-End Cable	Nylon	120"	50
4 GPX-P48-SS	P-End Cable <i>Work With Tracks: GPX-TK101-*, GPX-TR102-* & ALU851-*</i>	Stainless	48"	50
4 GPX-P120-SS	P-End Cable	Steel	120"	50
5 GPX-H48-N	Hex End Cable	Nylon	48"	50
5 GPX-H120-N	Hex End Cable	Nylon	120"	50
5 GPX-H48-SS	Hex End Cable <i>Work With Track: GPX-TK100-*</i>	Stainless	48"	50
5 GPX-H120-SS	Hex End Cable	Steel	120"	50

Picture Hooks

1



2



3



4



5



6



7



8



Part #	Description	Finish	Carton Qty.
1 GPX-HK5-NP	Self Gripping Hook		50
2 GPX-HK6-NP	L-End Hook		50
3 GPX-HK8-NP	Smart Spring		50
4 GPX-HK9-NP	Spring Hook	Bright	50
5 GPX-HK58-NP	Self Locking Hook	Nickel	50
6 GPX-HK7-NP	Self Gripping Hook		50
7 GPX-HK3-NP	L Hook		50
8 GPX-HK1-NP	J-End Hook		50

TRACKLESS 2MM CABLE HANGING SYSTEM FOR WALL & CEILING

Option 1: Stand Alone 2mm Cables

1. Adjustable Hinged Fitting Cable

Mounts on Walls & Ceilings



2. Standoff End Cable

Mounts on Walls



	Part #	Cable Material	Length	Ctn. Qty.
1	GPX-ADJ48-N	Nylon	48"	50
1	GPX-ADJ120-N		120"	50
1	GPX-ADJ48-SS	Stainless Steel	48"	50
1	GPX-ADJ120-SS		120"	50
2	GPX-STD48-N	Nylon	48"	50
2	GPX-STD120-N		120"	50
2	GPX-STD48-SS	Stainless Steel	48"	50
2	GPX-STD120-SS		120"	50

Option 2: Bulk 2mm Cable - Make Your Own

2MM Nylon Cable

GPX-CABLE-100

Material: Nylon
Cable Diameter: 2mm
Length: 100'



Economy Cable Looper

GPXE-HK41-M

Material: Aircraft Grade Aluminum
Finish: Mill
Cable Diameter: 2mm



Cable Looper

GPX-HK41-NP

Material: Solid Brass
Finish: Bright Nickel
Cable Diameter: 2mm



Economy Cable Looper



Cable Looper

Option 3: Premade Single Loop 2mm Cable with Ferrule



Nylon



Stainless Steel

	Part #	Material	Length	Ctn. Qty.
	GPX-L48-N	Nylon	48"	50
	GPX-L120-N		120"	50
	GPX-L48-SS	Stainless Steel	48"	50
	GPX-L120-SS		120"	50

TRACKLESS 2MM CABLE HANGING SYSTEM FOR WALL & CEILING

Mounting Options For 2mm Cable

1 S-Hook



▲ Works With
ALU851-*

2 Picture
Frame Hook



3



4



Fits Standard Ceiling Grids

	Part #	Description	Finish	Ctn. Qty.
1	GPX-HK10-NP	S-Hook	Bright Nickel	50
2	GPX-HK11-WW	L-End Hook	White	50
3	1215	Standard Twist Clip	White & Zinc	100
4	1216	Threaded Twist Clip	Plated Steel	100

Picture Hooks For 2mm Cable

1



2



3



4



5



6



7



8



	Part #	Description	Finish	Ctn. Qty.
1	GPX-HK5-NP	Self Gripping Hook	Bright Nickel	50
2	GPX-HK6-NP	L-End Hook	Bright Nickel	50
3	GPX-HK8-NP	Smart Spring	Bright Nickel	50
4	GPX-HK9-NP	Spring Hook	Bright Nickel	50
5	GPX-HK58-NP	Self Locking Hook	Bright Nickel	50
6	GPX-HK7-NP	Self Gripping Hook	Bright Nickel	50
7	GPX-HK3-NP	L Hook	Bright Nickel	50
8	GPX-HK1-NP	J-End Hook	Bright Nickel	50

ACCESSORIES FOR ALL CABLES

Hex Keys



CSK-HEX

Cable Cutter



CSK-CUTTER

Large Picture Stabilizer

Recommended for pictures 16" x 16" and up



GPX-HK13-NP

Apartment Hanger

HGHB-APT-*

- **Material:** Aluminum
- No drill, easy to install
- Foam liner, so no damage to walls
- Wall bracket holes drilled every inch
- Patented/Made in USA

The Hangman Apartment Hanger consists of two aluminum interlocking brackets modeled after the French Cleat featuring a built-in level which ensures an accurate installation. The aircraft grade aluminum brackets will not corrode and can be used indoors or outdoors. The system uses small nails which leave pin size holes and a foam back to protect walls from scuffs and marks. Once installed it can be adjusted left or right.



Part #	Size	Load Rating	Hardware Includes: (1) Wall Bracket, (1) Mounting Bracket, (1) Bubble Level,	
			#8 x 5/8" Screws	Nails
HGHB-APT-6	6" Long	50 lbs.	2	5
HGHB-APT-12	12" Long	100 lbs.	3	14
HGHB-APT-18	18" Long	150 lbs.	5	20

Heavy Duty Mirror & Picture Hanger

HGHB-HM-*

- **Material:** Aluminum
- Wall bracket holes drilled every inch
- Brackets are angled to ensure a flush mount
- Patented/Made in USA

The Hangman Heavy Duty Mirror & Picture Hanger is our classic and best selling product. It consists of two aluminum interlocking brackets modeled after the French Cleat featuring a built-in level which ensures an accurate installation. The aircraft grade aluminum brackets will not corrode and can be used indoors or outdoors on all surfaces. The system includes walldog anchorless fasteners.

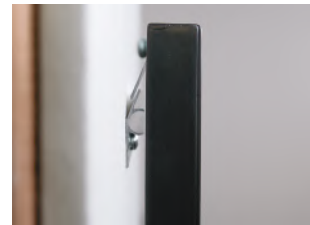

Part #	Size	Load Rating	Hardware Includes: (1) Wall Bracket, (1) Mounting Bracket, (1) Bubble Level,	
			#8 x 5/8" Screws	Walldog Screws
HGHB-HM-6	6" Long	75 lbs.	2	2
HGHB-HM-10	10" Long	100 lbs.	3	3
HGHB-HM-12	12" Long	100 lbs.	3	3
HGHB-HM-18	18" Long	200 lbs.	5	5
HGHB-HM-30	30" Long	300 lbs.	8	8
HGHB-HM-42	42" Long	300 lbs.	10	10

Professional French Cleat Hanger

HGHB-CBH-*

- **Material:** Aluminum
- Two piece system includes inset mounting bracket for a flush fit
- Aircraft grade aluminum
- Patented/Made in USA

The Hangman Professional French Cleat Hanger is a variation of the Heavy Duty Hangman and has several unique features. The overlapping design of the mounting bracket provides high torque leverage for use in hanging cantilevered shelves. The wall track is punched every inch making it easy to hit at least one stud. In addition to hanging shelves, it works great on cabinets, mirrors, and other heavy wall déco.



Part #	Size	Load Rating	Hardware Includes: (1) Wall Bracket, (1) Mounting Bracket, (1) Bubble Level,	
			#8 x 5/8" Screws	Walldog Screws
HGHB-CBH-18	18" Long	200 lbs.	5	5
HGHB-CBH-30	30" Long	300 lbs.	8	8
HGHB-CBH-42	42" Long	300 lbs.	10	10

Self Leveling Flushmount Hanger

HGHB-SCH-2

- **Material:** Aluminum
- Inset for a flush fit
- Aircraft grade aluminum
- Patented
- Works well with open back canvas

The Hangman Self Leveling Flushmount Hanger is a single piece hanger that attaches to the back of your canvas and hangs on the provided Bear Claw Hanger. The inset created allows the canvas to hang flush against the wall. Ideal for unframed canvas art. Also works on wooden frames.



Hardware Includes:

- (2) #4 x 5/8" Screws
- (2) Double Headed Bear Claw Screws
- (2) Sawtooths

Part #	Size	Load Rating
HGHB-SCH-2	38 x 22 mm	20 lbs.

Canvas Hanger

HGHB-CH-5

- **Material:** Aluminum
- Brackets are angled to ensure a flush mount
- Patented/Made in USA

The Hangman Canvas Hanger is a two piece bracket system that hangs giclees, gallery wraps, canvas or open back frames flush to the wall.

The wall track includes a bubble level for an accurate installation.



Hardware Includes:

- (2) #4 x 5/8" Screws
- (2) #8 x 1" Screws
- (1) Bubble Level
- (1) Mounting Bracket
- (1) Wall Bracket

Part #	Size	Load Rating
HGHB-CH-5	5" Long	20 lbs.

Aluminum Frame Hanger

HGHB-ALH-5

- **Material:** Aluminum
- Offset almost flush
- Single piece wall hanger

The Hangman Aluminum Frame Hanger is a one bracket system that is designed to hook into standard aluminum frames or specially designed wooden frames with an undercut.

The track includes a bubble level and anchorless Walldog fasteners for a fast and accurate installation.



Hardware Includes:

- (2) Walldog Screws
- (1) Bubble Level
- (1) Frame Hanger

Part #	Size	Load Rating
HGHB-ALH-5	5" Long	60 lbs.

Z-Hanger

HGZ-6948-* Z-Hanger

HGZL-6986-* Z-Lite Hanger

- **Material:** Aluminum
- **Load Rating:** 100 lbs. per ft. (HGZ-6948-*)
60 lbs. per ft. (HGZL-6986-*)
- Offset .22" (5.6 mm)
- Alternating holes every 1" (3/16" dia. & 1/4" dia.)
- Sold as pairs, including:
1" walldog screws & 5/8" bear claw screws
- HGZL-6986-*: Slight flexibility allows for easier engagement on non-plumb walls
- Sold in full cases only, where indicated (■)

The Hangman Z-Hanger consists of two aluminum interlocking brackets modeled after the French Cleat. The aircraft grade aluminum brackets will not corrode and can be used indoors or outdoors on all surfaces. The system is compatible with various fasteners, and can be adjusted left or right. Hangman's unique Z-Hanger comes with alternating holes punched every inch.



Part #	Size	Load Rating	Hardware Includes: (1) Wall Bracket, (1) Mounting Bracket,		Case Quantity
			#8 x 5/8" Screws	Walldog Screws	
HGZ-6948-18	18" Long	120 lbs./ft.	5	5	-
HGZ-6948-30	30" Long	120 lbs./ft.	8	8	-
■ HGZ-6948-18-12	18" Long	120 lbs./ft.	Hardware Not Included		6 sets
■ HGZ-6948-30-12	30" Long	120 lbs./ft.	Hardware Not Included		6 sets
■ HGZL-6986-18-12	18" Long	60 lbs./ft.	Hardware Not Included		6 sets
■ HGZL-6986-30-12	30" Long	60 lbs./ft.	Hardware Not Included		6 sets

Z-Man Mounting Bracket

HGZM-6318-*

- **Material:** Aluminum
- Slight flexibility allows for easier engagement on non-plumb walls
- Aircraft grade aluminum
- Alternating holes every 1" (3/16" dia. & 1/4" dia.)
- Easily cuttable with a carbide tip saw
- **Load Rating:** 60 lbs. per ft.
- Sold in full cases only,
6 sets/case



Hardware Not Included

Part #	Size	Load Rating
HGZM-6318-18-12	18" Long	60 lbs./ft.
HGZM-6318-30-12	30" Long	60 lbs./ft.

Walldog Safety Hanger

HGSH-WDH-*

- **Material:** Aluminum
- Aircraft grade aluminum
- Security lip prevents wire from slipping out
- 8 wide pivot point prevents frames from slipping
- Patented/Made in USA

The Hangman Walldog Safety Hanger is an extruded aluminum track that has a security lip to prevent picture hanging wire from slipping out. The wire is easy to insert and won't come out if bumped. The brackets are installed using anchorless Walldog fasteners that require no drilling and no stud. Friction bumpers included to keep walls clean and keep art from shifting.



Part #	Length	Load Rating	Hardware Includes:
HGSH-WDH-40	1-1/2"	40 lbs.	(1) Walldog, (1) Pair Bumper, (1) Hanger
HGSH-WDH-80	3"	80 lbs.	(2) Walldogs, (1) Pair Bumper, (1) Hanger

Bear Claw Hanger

HGSCR-*

- **Material:** Steel
- Self-drilling tip, no pilot hole required
- Works with D-rings, wire, keyhole & sawtooths
- **Load Rating:** 30 lbs. drywall, 100 lbs. stud
- Sold in full cases only

The Hangman Black Bear Claw Hangers work with D-rings, wire, sawtooths and keyholes for simple mirror and picture hanging solutions. Installs with a hand-held Phillips screwdriver. Self-drilling tip for easy installation.

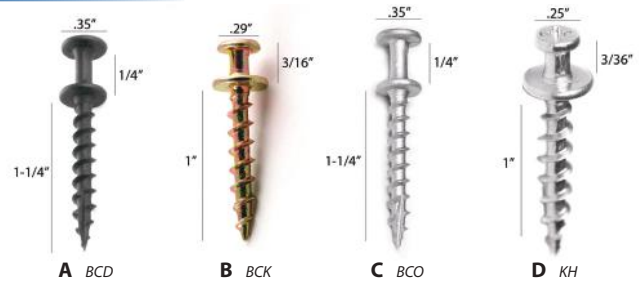

Part #	Length	Description	Case Quantity
A HGSCR-BCD-10P			10 pcs.
HGSCR-BCD-100	#8 x 1-1/4"	Black Oxide	100 pcs.
HGSCR-BCD-1000			1000 pcs.
B HGSCR-BCK-10P			10 pcs.
HGSCR-BCK-100	#8 x 1"	Zinc Plated	100 pcs.
HGSCR-BCK-1000			1000 pcs.
C HGSCR-BCO-10P		Special	10 pcs.
HGSCR-BCO-100	#8 x 1-5/8"	Outdoor	100 pcs.
HGSCR-BCO-1000		Coating	1000 pcs.
D HGSCR-KH-10P			10 pcs.
HGSCR-KH-100	#8 x 1"	.25" Head Size	100 pcs.
HGSCR-KH-1000			1000 pcs.

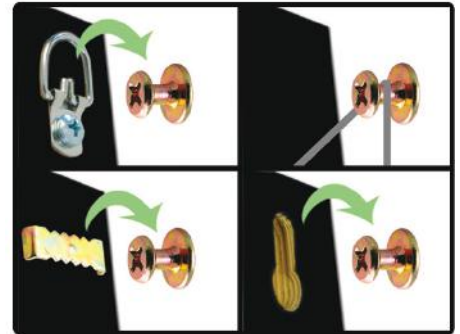

Furniture Anti-Tip Kit

HGA-TK-400

- **Material:** Steel
- Aircraft grade steel cables
- Secures dressers, curio cabinet, chests and entertainment centers
- **Load Rating:** 400 lbs.
- Also available for leaner mirrors

The Hangman Furniture Anti-Tip Kit consists of an aircraft grade steel cable that connects on one end to your furniture with a bracket installed into a stud on the wall. The cable prevents the furniture from tipping over. This kit is a leader in furniture safety.

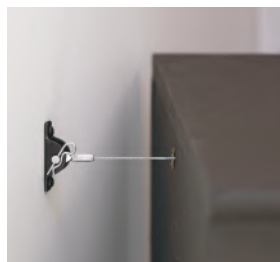

Hardware Includes:

- (2) #8 x 5/8" Screws
- (2) #8 x 1-1/2" Screws
- (2) Steel Brackets
- (2) Clevis Pins
- (2) Hair Pins
- (1) 6" Stainless Steel Cable

HGA-TK-400

Gallery Track

HGGS-GT-*

- **Material:** Aluminum
- Paintable

The Hangman Gallery Track is a part of Hangman's new gallery track system. They are a professional system that can be used at home or the office. Enjoy the ease of changing frames whenever you desire without damaging your walls. Available in 2', 3', 4', 6' and 8' lengths.

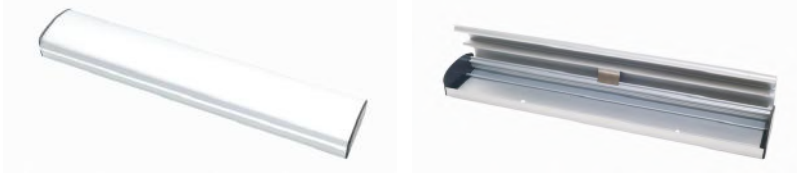

Part #	Length	Hardware Includes: (1) Connector, (1) Pair of End Caps, +
HGGS-GT-24	24"	(2) #8 x 1-1/2" Screws, (2) Anchors, (2) Sliders
HGGS-GT-36	36"	(2) #8 x 1-1/2" Screws, (2) Anchors, (3) Sliders
HGGS-GT-48	48"	(3) #8 x 1-1/2" Screws, (3) Anchors, (4) Sliders
HGGS-GT-72	72"	(3) #8 x 1-1/2" Screws, (3) Anchors, (6) Sliders
HGGS-GT-96	96"	(3) #8 x 1-1/2" Screws, (3) Anchors, (8) Sliders

Accessories for Gallery Track

GALLERY HOOKS

- **Material:** Chrome Plated Zinc
- Tension hooks grip when pulled down
- Push button to move upwards



HGGS-GT-H

GALLERY WIRE

- **Material:** Chrome Plated Zinc
- High Grade Wire
- Works only with our gallery track
- Can be coiled to control length
- **Available in 8' lengths**



HGGS-GT-8W 8 ft. Length

GALLERY HANGING BRACKET

- **Material:** Chrome Plated Zinc
- Works only with our gallery track
- Slides left or right for positioning
- Holds our gallery track cables

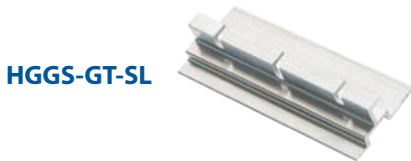

HGGS-GT-SL

GALLERY TRACK CONNECTOR

- **Material:** Chrome Plated Zinc
- Makes aligning tracks easy



HGGS-GT-C

GALLERY TRACK END CAPS

- **Material:** Plastic
- Gives a finished look



HGGS-GT-EC

Christmas Light Hangers

HGSH-QH-*

- **Material:** Stainless Steel
- Screws have an open loop (5/32" opening)
- **Load Rating:** 100 lbs. in wood beam or stud
- *Sold in full cases only*

The Hangman Christmas Light Hangers are an all year outdoor stainless steel wire holder. A simple way to hang holiday lights, bird feeders, bird houses, wind chimes, etc. Installs easily and is wind and weather resistant with a lifetime warranty. These are made to last.

Part #	Size	Case Quantity
HGSH-QH-12	38 x 22 mm	12 pcs.
HGSH-QH-20		20 pcs.



Elephant Hook Ceiling Hook

- **Material:** Steel
- Weather resistant coating
- Swivels & locks
- **Load Rating:** Holds 20 lbs. in drywall, 100 lbs. in wood

Elegant and easy, the Elephant Hook ceiling hook installs in under a minute. No drilling or pilot hole necessary. Simply screw in the self-drilling double-headed Bear Claw Hanger. Snap the Elephant Hook in place over the exposed collar. Swivel to desired angle and allow the weight of your item to lock into place. Comes in three finishes to match decor. For use indoor or outdoors, holds 100 lbs. in wood, 20 lbs. in drywall.

Hardware Includes:

- (1) Elephant hook
- (1) #8 x 1-1/4" Double-headed screw
- (1) Snap screw

Part #	Finish
HGH-EH-B	Bronze
HGH-EH-N	Nickel
HGH-EH-W	White



HGH-EH-N Nickel



HGH-EH-B Bronze



HGH-EH-W White

Push and Hang

HGSH-PSH-*

- **Material:** Steel Plating
- Pushed directly into drywall
- Creates an easy hanging surface
- *Sold in full cases only*

Push and hang. Absolutely the simplest and easiest to use picture hanger on the planet! Simply push into drywall, no tools needed.

Part #	Size	Load Rating	Case Quantity
HGSH-PSH-S-100	9 x 26 mm	10 lbs.	100 pcs.
HGSH-PSH-S-1000			1000 pcs.
HGSH-PSH-L-100	16 x 35.5 mm	20 lbs.	100 pcs.
HGSH-PSH-L-1000			1000 pcs.



Shelf Guard

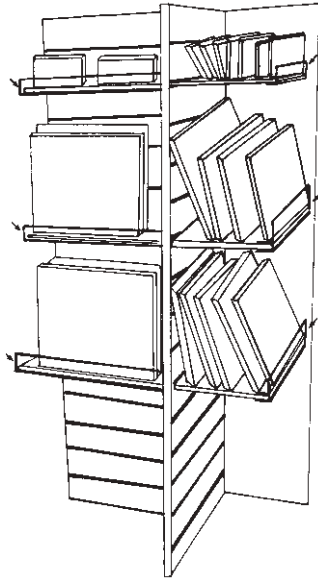

Material: Clear Butyrate

FITS GLASS:

3/16"

7/32"-1/4"

1/4"

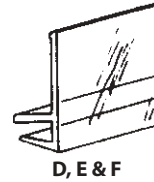
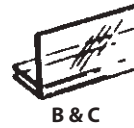
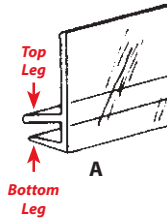

Part #	Fits Glass:	Height	Top Leg	Bottom Leg	Length
A SE-316-4	3/16"	7/16"	13/32" L	11/32" L	48"
B SE/248	7/32"-1/4"	2"	3/8" L	5/16" L	48"
C SE/260	7/32"-1/4"	2"	3/8" L	5/16" L	60"
D SE-14-4	1/4"	3/4"	29/64" L	27/64" L	48"
E SE-14-5	1/4"	3/4"	29/64" L	27/64" L	60"
F SE-14-6	1/4"	3/4"	29/64" L	27/64" L	72"

Plastic Tubing & Accessories For Sign Holders

WHITE ROUND PLASTIC TUBING

Material: PVC

NOTE: White Styrene & White PVC color may not be identical

Please Inquire for End Caps & Glides.

Part #	O.D.	I.D.	Length
PD125-WH	1-1/4"	1-1/8"	8 ft.

POLE SIGN CLAMP

Material: Styrene

- Color: White
- For use with 1" tubing
- Excellent for use on cut case display

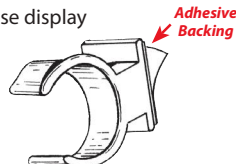
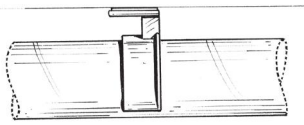

Part #	Tube O.D.
PSC-10	1"

POLE TOP SIGN HOLDERS

Material: Styrene

- Color: White
- For use with 1" & 1-1/4" tubing
- Holds signs up to .080" thick

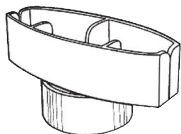

Part #	Tube O.D.
PSH-125	1-1/4"

Table Skirting Clips

Material: Rigid PVC
Length: 3" Long



All clips come with strip of velcro® to attach fabric.



Part #	Description	Fits:
TSC-0750	Without Hook	3/4"
TSC-0750H	With Hook	3/4"

S-Hooks

Material: Zinc Plated Steel

- .080" • 1-3/4" Long
- Hang from shelf edge or wire fixtures
- Strip Hooks available in "Open Ended" & "Pinched"
 - Open ended for use with all merchandising strips
 - Pinched style assures strip stays on hook

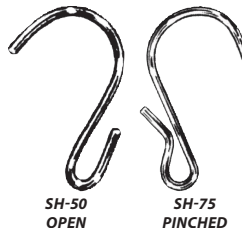

Part #	Type
SH-50	Open
SH-75	Pinched

Z-PANEL HANGERS & CLIPS

"A FAST, EASY & COST EFFECTIVE METHOD OF HANGING CABINETS, WALL PANELS, PARTITIONS & SIGNAGE!"

Lift-Off is the space needed to raise the panel over the resting height

Projection is the distance between the wall and the panel

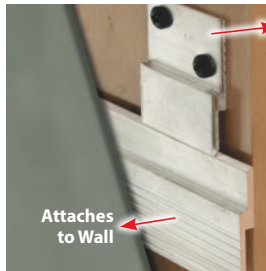
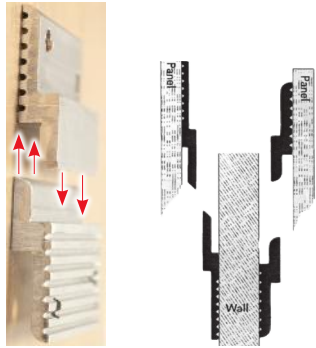

Attaches to Cabinet

HOLES & SPACING:

- Pre-cut pieces: 1-1/2" distance (except where noted)
- 4 ft., 8 ft. & 12 ft. Lengths: 8" on center

Note: All holes are 3/16" diameter and accommodate #10 screws.

For our Acrylic Z & W Bar, see page 75

Pre-Cut with 2 Punched Holes

Part #	Length
ALU111-2-M	1.5 in.

4 ft. & 8 ft. Lengths without Holes

Part #	Length
ALU111-4	4 ft.
ALU111-8	8 ft.

with Punched Holes

Part #	Length
ALU111-4H	4 ft.
ALU111-8H	8 ft.

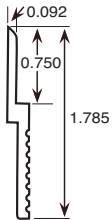

Projection: 0.180"
Lift-Off: 0.750"

Pre-Cut with 2 Punched Holes

Part #	Length
ALU112-2-M	2 in.

4 ft. & 8 ft. Lengths without Holes

Part #	Length
ALU112-4	4 ft.
ALU112-8	8 ft.

with Punched Holes

Part #	Length
ALU112-4H	4 ft.
ALU112-8H	8 ft.

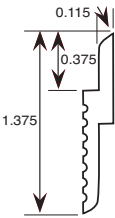

Projection: 0.240"
Lift-Off: 0.375"

Pre-Cut with 2 Punched Holes

Part #	Length
ALUHAC22-2-M	2 in.

12 ft. Lengths without Holes

Part #	Length
ALUHAC22-M	12 ft.

with Punched Holes

Part #	Length
ALUHAC22-MH	12 ft.

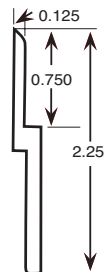

Projection: 0.250"
Lift-Off: 0.750"

Pre-Cut with 2 Punched Holes

Part #	Length
ALUHAC23-2-M	2 in.

12 ft. Lengths without Holes

Part #	Length
ALUHAC23-M	12 ft.

with Punched Holes

Part #	Length
ALUHAC23-MH	12 ft.

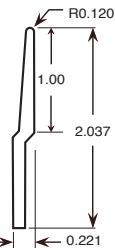

Projection: 0.210"
Lift-Off: 1.000"

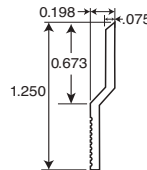

Projection: 0.198"
Lift-Off: .673"

4 ft. & 8 ft. Lengths without Holes

Part #	Length
ALU333-4-M	4 ft.
ALU333-8-M	8 ft.

with Punched Holes

Part #	Length
ALU333-4-MH	4 ft.
ALU333-8-MH	8 ft.

Pre-Cut with 2 Punched Holes

Part #	Length
ALU211-2-M	2 in.

4 ft. & 8 ft. Lengths without Holes

Part #	Length
ALU211-4	4 ft.
ALU211-8	8 ft.

with Punched Holes

Part #	Length
ALU211-4H	4 ft.
ALU211-8H	8 ft.

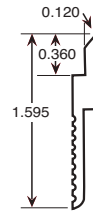

Projection: 0.250"
Lift-Off: .360"

Pre-Cut with 2 Punched Holes (1-3/4" Distance)

Part #	Length
ALUHA4049-25-M	2.5 in.

4 ft. & 8 ft. Lengths without Holes

Part #	Length
ALUHA4049-4-M	4 ft.
ALUHA4049-8-M	8 ft.

with Punched Holes

Part #	Length
ALUHA4049-4-MH	4 ft.

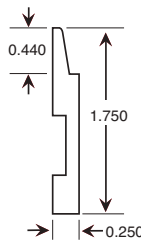

Projection: 0.240"
Lift-Off: .440"

Pre-Cut with 2 Punched Holes (1-3/4" Distance)

Part #	Length
ALUS4049-25-M	2.5 in.

4 ft. & 8 ft. Lengths without Holes

Part #	Length
ALUS4049-4-M	4 ft.
ALUS4049-8-M	8 ft.

with Punched Holes

Part #	Length
ALUS4049-4-MH	4 ft.
ALUS4049-8-MH	8 ft.

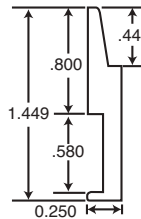

Projection: 0.250"
Lift-Off: .440"

Bubble Level

Acrylic bubble level used for leveling our panel clips, or any other horizontal surface.
9/16"W x 1-9/16"L



BL-1

LIGHT DUTY PVC SLATWALL PANELS

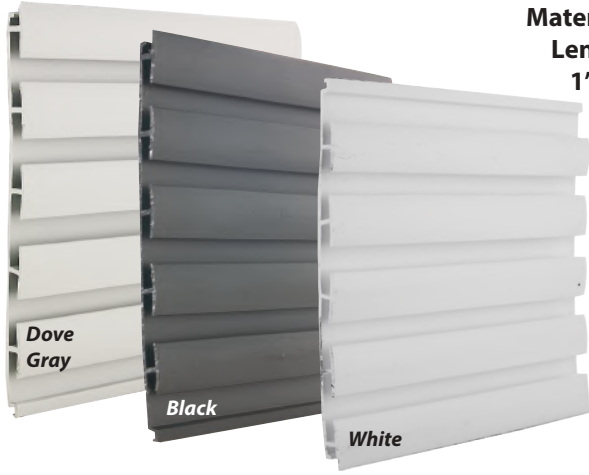

Material: RIGID PVC
Length: 6" x 48"
1" on Center

- Panel 5/16" thick
- 4-5 lbs. per sq. ft. load capacity
- Easy-to-Install
- Lightweight, yet strong
- Acid & alkali resistant

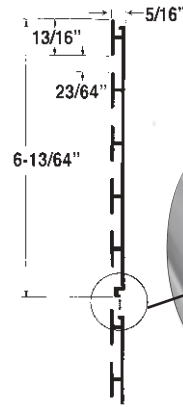

Unique Interlocking Design

Part #	Color
SLAT648	White
SLAT648BK	Black
SLAT648DG	Dove Grey

All Colors Are Non-Stock Items, Please inquire.

DOUBLE SIDED ALUMINUM SLATWALL PANELS



Material: Aluminum
Length: 5" x 12'
1-1/2" on center

- Panel 1/2" thick
- 100 lbs. per sq. ft. load capacity

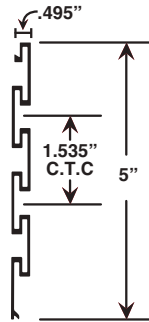

2 SIDED



Innovative design: Allows for use of both sides of the panel

For use with all accessories in the Slatwall Hardware section except the following: SWB/1266*, SWB/12124* & SWB/12244*

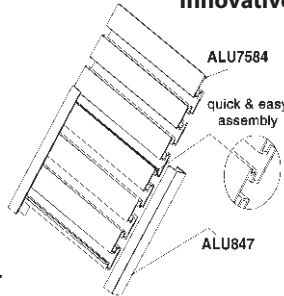

Finishes available: CLEAR ANODIZED & MILL

Part #	Finish	Description	Per Ctn.
ALU7584-M	Mill	5" x 12' Long Slatwall	6 pcs.
ALU7584-S	Clear Anodized	5" x 12' Long Slatwall	6 pcs.

End Channel For Edges

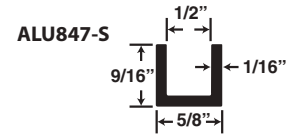

Part #	Finish	Description
ALU847-M	Mill	12' Long
ALU847-S	Clear Anodized	12' Long

Other colors available. Minimums apply. Please inquire.

MAKE YOUR OWN SLATWALL

BEVEL T-SLOT ROUTER BIT

Carbide Tipped - 2 Flute

- Designed for creating T-slot/Slatwall panels.
- Creates radius edges for easier insertion of accessories in the slatwall.
- Bits are not designed for plunging operations.
- It is recommended the use of a CNC (computer numeral control) router or a table-mounted router.

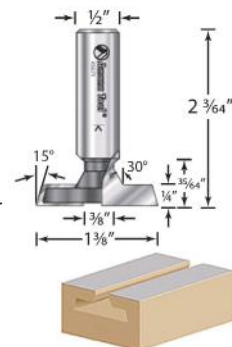

Part #
TSLOT-710

Can use ALU710-M as insert

SLATWALL INSERTS

ALUMINUM INSERT FOR SLATWALL

Fits Marlite Brand Slatwall
 Mill Finish • 8 ft. Lengths

Part #
ALU710-M

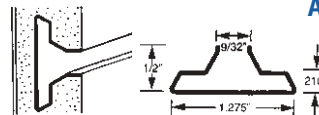

VINYL INSERT FOR WOOD SLATWALL

Fits the SW48 Wood and Marlite Brand Slatwall
 8 ft. Lengths

Part#	Color
SLAT-J-BK	Black
SLAT-J-WH	White
SLAT-J-LG	Light Gray
SLAT-J-IV	Ivory

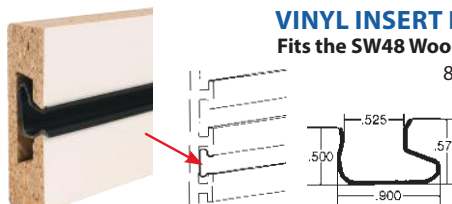

GREAT WALL PVC & ALUMINUM SLATWALL SYSTEM

UNIQUE INTERLOCKING DESIGN SECURELY FITS TOGETHER



HERCULES HEAVY DUTY PANELS

Material: Aluminum
Length: 6" x 8' • 3" on center

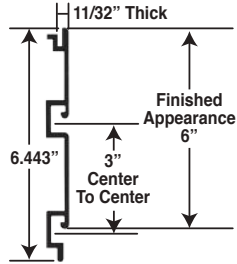

- Panel 11/32" thick
- 300 lbs. per sq. ft. load capacity
- Aluminum slatwall designed to interlock with heavy duty PVC slatwall when extra strength is needed.

Part #	Finish
ALU6969-S	Satin
ALU6969-M	Mill

SUPER STRONG

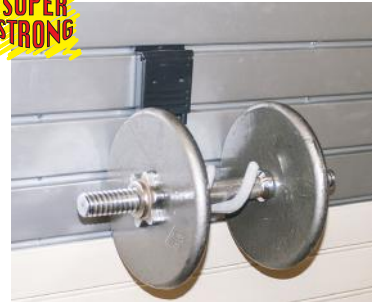

For use with all accessories in the slatwall hardware section, please inquire.

HIGH DENSITY HEAVY DUTY GREAT WALL PANELS

Material: PVC
Lengths: 1' x 4' and 1' x 8' • 3" on center

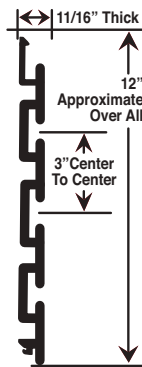

- Panel 11/16" thick
- 100 lbs. per sq. ft. load capacity

Part #	Color	Size
GRW-HD1X4BX-WH	White	1' x 4'
GRW-HD1X4BX-BK	Black	8 pcs. per box
GRW-HD1X4BX-GY	Gray	
GRW-HD1X8BX-WH	White	1' x 8'
GRW-HD1X8BX-BK	Black	4 pcs. per box
GRW-HD1X8BX-GY	Gray	

Must be ordered in full boxes

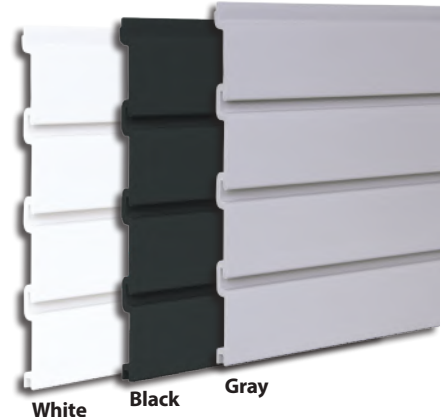

COMING SOON!

New!

- 80" LENGTH!
- 4 FINISHES!
Taupe
Graphite
Beachwood
Driftwood Slate

SLATWALL ACCESSORIES

Ticket Holder

Clear Butyrate
12 ft. Lengths
Fits 1-1/4" Ticket

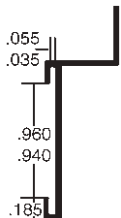

Part #
62-CL

Aluminum Slatwall 3/4" Thick Shelf Support Bracket

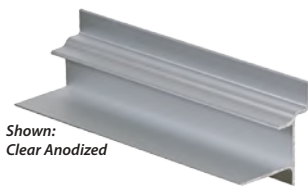

Shown:
Clear Anodized

- Material: Aluminum
- Works with 3/4" shelf
- Holds up to 12" deep shelf
- Load Rating:
20 lbs. per linear ft.

- EASY AS:
- 1 - PICK SHELF LENGTH
 - 2 - INSERT SHELF INTO EXTRUSION
 - 3 - HANG ON SLATWALL

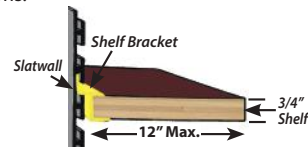

The Hangman Slatwall 3/4" Shelf Bracket is an aluminum extrusion that is designed to accept any 3/4" wood or melamine panel. Insert the panel and set with a screw from the underside. Available in clear anodized, or powder coated black. Custom sizes available. A great way to improve your garage or slatwall systems.

HANGMAN
PRODUCTS
WHOLESALE



Shown:
Black Powder Coated

Part #	Size	Finish
HGSW-750-24-C	24" Long	Clear Anodized
HGSW-750-48-C	48" Long	
HGSW-750-96-C	96" Long	
HGSW-750-24-B	24" Long	Black Powder Coated
HGSW-750-48-B	48" Long	
HGSW-750-96-B	96" Long	

PLASTIC VENT GRILLES

Material: Styrene

Available in ***White (WH)**, ***Black (BK)**
***Silver Gray (SG)** or ***Tan (TN)**

Designed to provide air circulation where needed

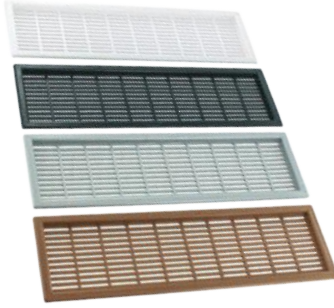

G-1970-*
Shown in White, Black,
Silver Gray and Tan

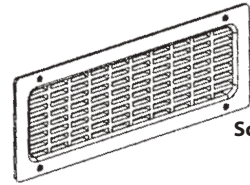

G-1971-*
Screw Mount

Part #	Overall Size	Hole Size	Mounting Type
G-1970-*	2-5/8" x 8-7/8"	2-3/8" x 8-5/8"	Glue On
G-1971-*	3-9/16" x 9-11/16"	2-5/8" x 8-31/32"	Screw Mount
G-1972-*	3-9/16" x 9-11/16"	2-5/8" x 8-31/32"	Glue On
G-1975-*	2-7/8" x 8-3/4"	2-7/16" x 8-3/8"	Glue On

ROUND PLASTIC VENTS

Material: Styrene

Available in ***White (WH)**, ***Black (BK)**, or ***Silver (SG)**

Designed to provide air circulation where needed



Part #	Overall Dia.	Drill Hole	
		Dia.	Height
G-200-*	2-3/8"	2"	5/8"
G-250-*	2-11/16"	2-1/2"	3/4"
G-300-*	3-3/8"	3"	3/4"

VENTS



Round



Material: 304 Stainless Steel
Satin finish

0.4 fine mesh wire diameter
Screws included



Elongated
Oval



Part #	O.D.	I.D.	Thickness
SAM-45	1.8125	1.641"	.2047"
SAM-60	2.359	2.109"	.2362"
SAM-85	3-344	3.062"	0.2441"

Part #	O.D.	I.D.	Thickness
SAD-150	5.906" x 1.578"	5.65" x 1.339"	0.2441"
SAD-200	7.891" x 1.969"	7.638" x 1.732"	0.2441"

INDUSTRIAL VENTS



A



B



C



D



Material: 316 Stainless Steel
Satin finish

Screws not included

Part #	Length	Width	Thickness
A 1-1122	8-15/32"	4-1/8"	.2362"
B 1-1212	4-17/32"	4-17/32"	.2362"
C 1-2211	8-15/32"	4-1/8"	.2362"
D 1-2222	8-15/32"	8-15/32"	.2362"

LOCKING VENTED HOLE PLUGS

All available in Black, or add a "W" for White.



Part #	Hole Dia.	Maximum Thickness	A Head Dia.	B Thickness
MP-0750V	0.750"	0.125"	0.906"	0.406"
MP-0875V	0.875"	0.125"	1.1016"	0.453"

REMOVABLE VENTED NYLON PLUGS AVAILABLE, PLEASE INQUIRE!



BINNING STRIPS

OUR BINNING STRIP MAKES IT EASY TO ADJUST SPACING & ACCOMMODATE YOUR NEEDS

Material: Ivory, White, Black & Clear Styrene

Versatile plastic band strip can be installed on counters, tables, cabinets, in drawers - anywhere. Accepts various types of dividers. Economical yet easily installed.



STANDARD BINNING STRIP FOR 1/4" DIVIDER

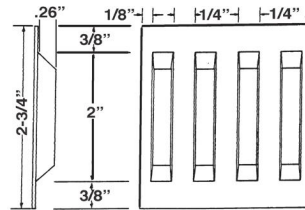
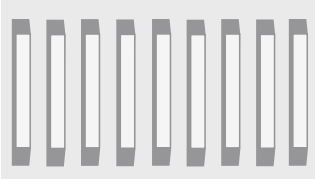

Part # Description

NO ADHESIVE

282-CL-48	48"-Clear
282-CL-60	60"-Clear
282-IV-48	48"-Ivory
282-IV-60	60"-Ivory
282-WH-48	48"-White
282-WH-60	60"-White
282-BK-60	60"-Black

WITH ADHESIVE

282A-CL-48	48"-Clear
282A-CL-60	60"-Clear
282A-IV-48	48"-Ivory
282A-IV-60	60"-Ivory
282A-WH-48	48"-White
282A-BK-48	48"-Black
282A-WH-60	60"-White
282A-BK-60	60"-Black



STANDARD BINNING STRIP FOR 1/8" DIVIDER

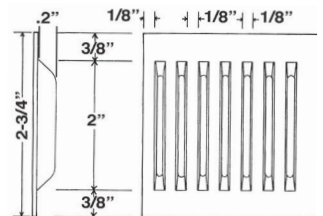
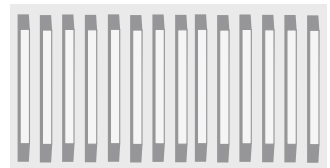

Part # Description

NO ADHESIVE

182-CL-60	60"-Clear
182-IV-60	60"-Ivory
182-WH-60	60"-White
182-BK-60	60"-Black

WITH ADHESIVE

182A-CL-60	60"-Clear
182A-IV-60	60"-Ivory
182A-WH-60	60"-White
182A-BK-60	60"-Black

STANDARD BABY BINNING STRIP FOR 1/4" DIVIDER

Works independently of standard binning strip

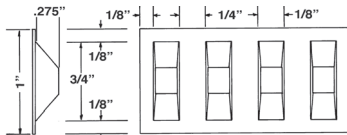

Part # Description

NO ADHESIVE

292-BK-60	60"-Black
292-CL-60	60"-Clear
292-IV-60	60"-Ivory
292-WH-60	60"-White

WITH ADHESIVE

292A-BK-60	60"-Black
292A-CL-60	60"-Clear
292A-IV-60	60"-Ivory
292A-WH-60	60"-White

BIN COMPONENTS

A. Ratchet/Binning Strip

Ivory • 30" Lengths
Material: PE
Allows north & south division

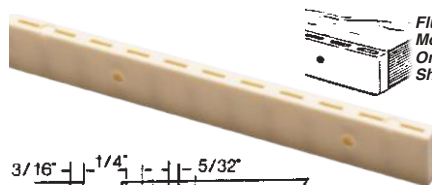

Part #

6510-30

B. End Splicer For Ratchet Strip

Holds 1/4" Material
Material: Steel Nickel Plated
Allows north & south division

Part #
2123-30



C. Ratchet Splicer For 1/4" Glass Shelf

ABC CLIP
Use at top or bottom of glass
Material: Steel Zinc Plated
Allows east to west division

Part #
2191-01



EXTRUDED CLEAR ACRYLIC TUBES & RODS

Length: 6 Ft.

Round Tubes

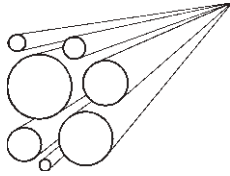

Part #	O.D.	I.D.	Wall Thick.
10702	5/16"	3/16"	1/16"
10703	3/8"	1/4"	1/16"
10704	3/8"	1/8"	1/8"
10705	1/2"	3/8"	1/16"
10706	1/2"	1/4"	1/8"
10708	5/8"	1/2"	1/16"
10709	5/8"	3/8"	1/8"
10710	3/4"	5/8"	1/16"
10711	3/4"	1/2"	1/8"
10712	7/8"	3/4"	1/16"
10713	7/8"	5/8"	1/8"
10714	1"	7/8"	1/16"
10715	1"	3/4"	1/8"
10716	1-1/4"	1"	1/8"
10717	1-1/4"	1-1/8"	1/16"
10718	1-1/2"	1-1/4"	1/8"
10719	1-5/8"	1-3/8"	1/8"
10720	1-3/4"	1-1/2"	1/8"
10721	2"	1-3/4"	1/8"
10723	2-1/4"	2"	1/8"
10724	2-1/2"	2-1/4"	1/8"
10725	2-3/4"	2-1/2"	1/8"
10726	3"	2-3/4"	1/8"
10727	4"	3-3/4"	1/8"
10728	4 1/2"	4-1/4"	1/8"
10729	5"	4-3/4"	1/8"
10730	6"	5-3/4"	1/8"

Round Rods

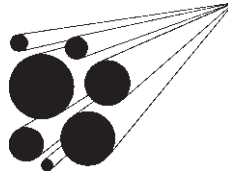

Part #	Diameter
10102	1/8"
10103	3/16"
10104	1/4"
10105	5/16"
10106	3/8"
10108	1/2"
10110	5/8"
10111	3/4"
10112	7/8"
10113	1"
10114	1-1/8"
10115	1-1/4"
10116	1-1/2"
10117	1-3/4"
10118	2"

Square Rods

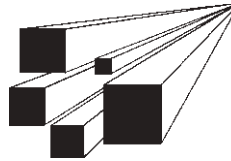

Part #	Square
10301	1/8"
10302	3/16"
10303	1/4"
10304	3/8"
10305	1/2"
10307	3/4"
10308	1"

Half Round Rods

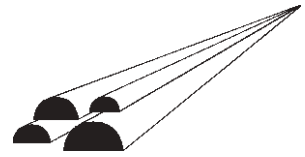

Part #	Diameter
10201	1/2"
10202	5/8"
10203	3/4"
10204	1"

Rectangular Rods

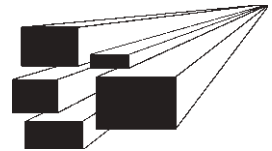

Part #	Size
10801	1/8" x 3/8"
10802	1/8" x 5/8"
10805	1/4" x 1/2"
10806	1/4" x 1"
10807	5/8" x 1"
10808	3/4" x 1"

Square Spiral Rods

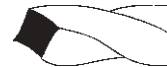

Part #	Point To Point
10502	1/2"
10503	5/8"
10504	3/4"

SLATWALL HARDWARE / ACRYLIC FABRICATING PRODUCTS

"Z" & "W" Bar

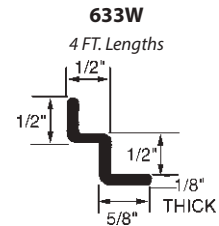
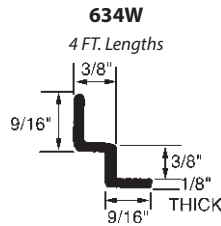
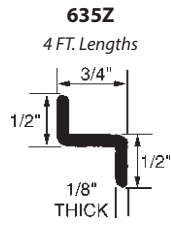
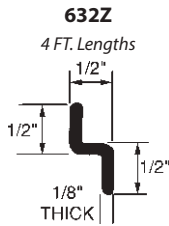

Material: Clear Acrylic- 25% DR

Material: Clear Acrylic- 100% DR

Part #
632Z-4
635Z-4
633W-4
634W-4

Part #
632Z-100-4
635Z-100-4
633W-100-4
634W-100-4

Slatwall Adapter Clip



Material: Styrene

- Attaches signs, literature holders & lightweight displays flush up against slatwall.
- 1" clip fits most standard slatwall



Adhesive holds sign or display

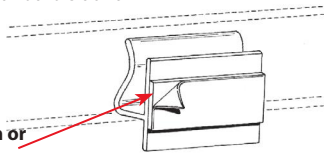

Part # **SWA-10** Color White

"Z" Bar Slatwall Adapter

Material: Crystal Clear PVC

- Holds signs and lightweight literature holders to slatwall.
- 2-3/8" wide adapter
- Permanent foam tape self adhesive included.

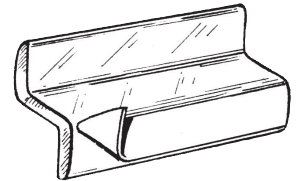

Part # **ZB-20**

Acrylic Sign Channel

Make Your Own Sign!

Now you can easily design and manufacture multitrack changeable signs in any width you desire with our Acrylic Sign Channel. The acrylic sign channels have 1/4" wide adhesion surfaces. Adhesive sold separately.

CLEAR ACRYLIC
6 FT. LENGTHS

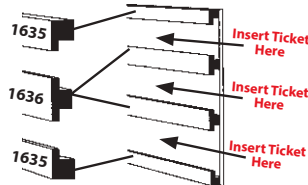

Part #
1635
1636

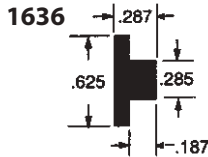
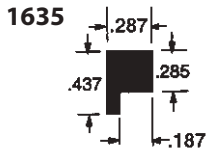

Vision Ware Rests

CLEAR ACRYLIC
Glue Onto 5/8" Rod



Part # **R21-1**

CLEAR ACRYLIC
Glue Onto Flat Surface



Part # **R21-2**

Clear Polyester Hooks

1/8" ROUND

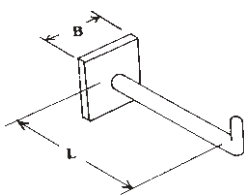

Part #	L	B
RH-32	1"	1/2" sq.
RH-48	1-1/2"	5/8" sq.

1/2" Adjustable Merchandising Hook System

CLEAR POLYESTER
1-1/2" RIBBON CLIP HOOK

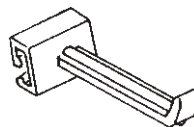

Part # **RCH-48**

CLEAR ACRYLIC
6 FT. LENGTHS

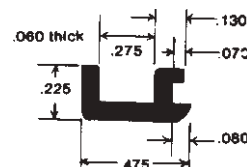

Part # **EA-30CL**

ACRYLIC FABRICATING PRODUCTS

Locks

DECO-HASP

Material: Acrylic DR101 (Clear), ABS (Black)

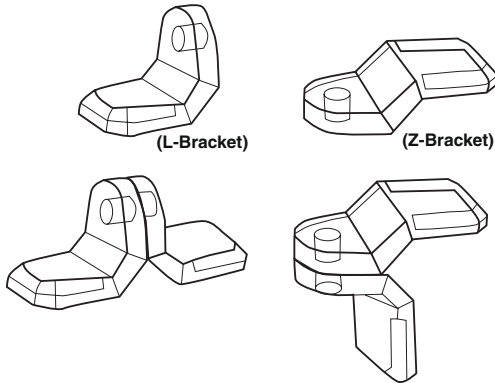

Innovative locking hasp designed for corner or flat applications. No moving parts reduce breakage in the field. Solvent bonds to acrylic, polycarbonate, ABS and styrene.

Part #	Description
DECO-HASP-LCL	Clear Acrylic 7/8" L x 3/4" W x 3/4" H Flat Mount Hasp
DECO-HASP-LBK	Black ABS 7/8" L x 3/4" W x 3/4" H Flat Mount Hasp
DECO-HASP-ZCL	Clear Acrylic 1-3/8" L x 3/4" W x 7/16" H Corner Mount Hasp
DECO-HASP-ZBK	Black ABS 1-3/8" L x 3/4" W x 7/16" H Corner Mount Hasp

Catches

MAG-CATCH™ with Strike Plate

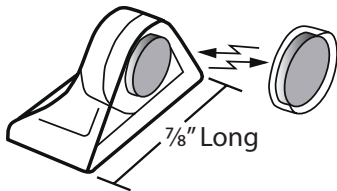

- Material: Acrylic DR101
- Pull Force: 1 lb.
- Size: 7/8" L x 1/2" H x 3/8" W
- Adhesive mount

Adhesive mount solvent bonds to acrylic, polycarbonate, ABS and styrene. Eliminates unsightly screws or hardware.

Part #	Description
MC-SM-CL	Clear Acrylic Magnetic Door Catch

Door Catch

with Strike Plate



- Material: Clear Acrylic
- Size: 5/8" L x 1-5/16" W
- Adhesive mount

Part #
DC-100-CL

ACRYLIC HASP

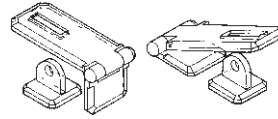

- Color: Clear or Black
- 2-3/8" Long x 1-1/16" Wide x 1/8" Thick

Bottom section of hasp is reversible for either corner or flat mounting.
Pre-determine assembly before inserting pin completely!

Part #	Color
HSP-110-CL	Clear
HSP-110-BK	Black

Shelf Pilasters

SHELF TRACKER™

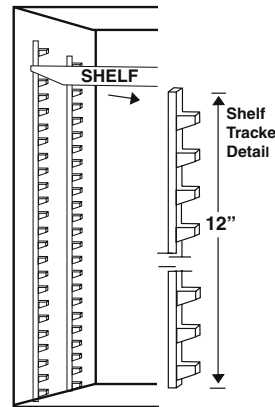

- Material: Clear Acrylic
- Length: 12" long
- For up to 1/4" thick shelves with 1/2" adjustment
- Easily mates for longer applications
- Solvent bonds to Acrylic, ABS, Polycarbonate and Styrene
- Size: 12" L x 5/16" W x 3/8" T (305mm x 87mm x 9.5mm)

Part #	Description
ST-CL	Clear Acrylic Shelf Tracker

Business Card Holder

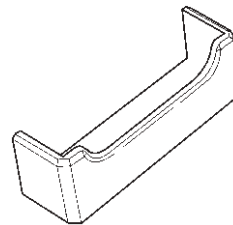

- Material: Clear Acrylic
- Size: 3-5/8" W x 3/4" D x 7/8" H

Part #
BC-200-CL

ACRYLIC FABRICATING PRODUCTS

Hinges

CLEAR FLAT HINGES

.086 Thick - PVC
100 Ft. Coils -
Clear with White Web

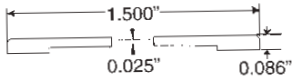

Part #
P4169-CL

CLEAR ACRYLIC/PVC
5 Ft. Lengths

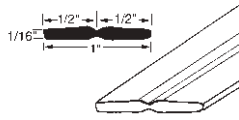

Part #
696H

CLEAR P.E.T.G./PVC
with glue groove
5 Ft. Lengths

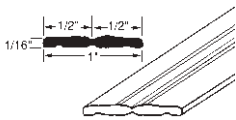

Part #
9888H

CLEAR URETHANE & ACRYLIC
4 Ft. Lengths
U.V. Stabilized for Outdoor Use!

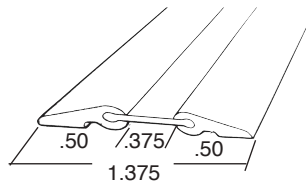

Part #
F2000-CL

CLEAR ECONOMY ACRYLIC HINGE

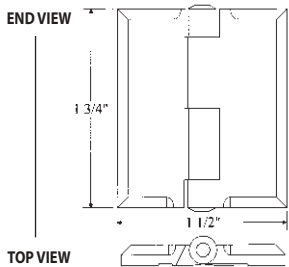

Part #
EC175-150

*Larger Quantities Available
- Please Inquire*

PIANO HINGE

Clear or Black
12" Long x 1-3/4" Wide

• Outer bonding surface is wide for added bonding strength.

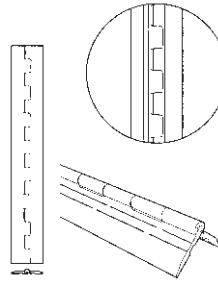

Part #	Material
PH-175-12CL	Acrylic
PH-175-12BK	ABS

CLEAR ACRYLIC HINGE

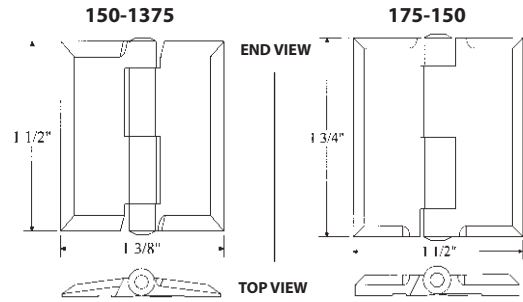

Part #
150-1375
175-150

POLYPROPYLENE HINGE

Black or White
Screw Size Recommended
#10 Countersunk (not included)

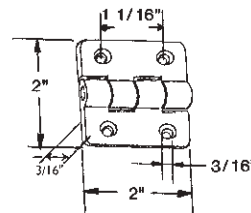

Part #	Color
200-200-WH	White
200-200-BK	Black

Won't Rust - Quiet - Long Life

MONSTER HINGE™

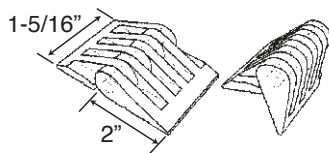

Material: Acrylic DR101 (Clear), ABS (Black)

- New design makes this hinge virtually unbreakable!
- Large ribbed sections added for superior strength!
- Larger pin diameter (.190" dia.)

Part #	Description
MONSTER-HINGE-CL	Clear Acrylic 1-5/16" L x 2" W x 1/2" Thick Hinge
MONSTER-HINGE-BK	Black ABS 1-5/16" L x 2" W x 1/2" Thick Hinge

Hangers

SAWTOOTH HANGER

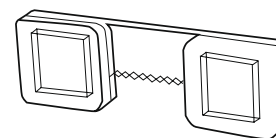

Material: Clear Acrylic

Part #	Description
SAWTOOTH-HANGER	Clear Acrylic 2-1/4" W x 3/4" H x 1/4" D Sawtooth Hanger

KEYHOLE HANGER

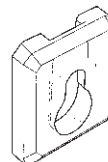

CLEAR ACRYLIC
1" W x 1-1/8" H x 1/4" Thick

Part #
KH-100-CL

CONTINUOUS STEEL PIANO HINGE

AVAILABLE FINISHES:

Nickel, Brite Brass, *304 Grade Stainless Steel, Statuary Bronze, Electro Black Lacquered

3 SIZES:

1-1/4" x 72", 1-1/2" x 72", 2" x 72"

1 1-1/4" x .030* x 72"

Part #	Finish
PH-28-72N	Nickel
PH-28-72B	Brite Brass
PH-28-72BZ	Statuary Bronze
PH-28-72BLQ	Electro Black Lacquered
PH-28-72SS	*304 Grade Stainless Steel

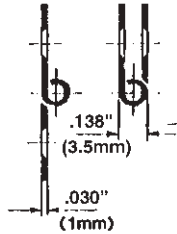

2 1-1/2" x .040* x 72"

Part #	Finish
PH-40-72N	Nickel
PH-40-72B	Brite Brass
PH-40-72BZ	Statuary Bronze
PH-40-72BLQ	Electro Black Lacquered
PH-40-72SS	*304 Grade Stainless Steel

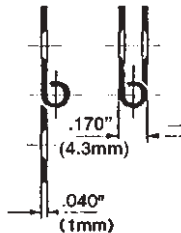

3 2" x .040* x 72"

Part #	Finish
PH-64-72N	Nickel
PH-64-72B	Brite Brass
PH-64-72BZ	Statuary Bronze
PH-64-72BLQ	Electro Black Lacquered
PH-64-72SS	*304 Grade Stainless Steel

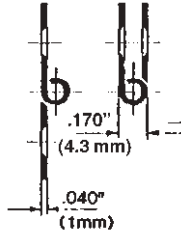

* All Stainless Steel Hinges are .037" Thick

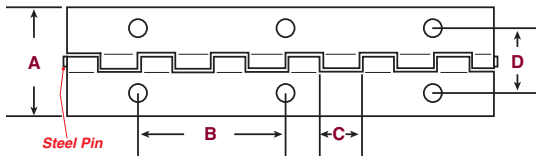

DIMENSIONS

	A	B	C	D
1	1-1/4"	2"	1/2"	.750"
2	1-1/2"	2"	1/2"	.876"
3	2"	2"	1/2"	1.13"

NOTE: All measurements are approximate; please refrain from drilling your holes until product is received.

If you are interested in aluminum hinges or custom lengths, please inquire.

PIANO HINGE FLAT PHILLIPS SCREWS

Part #	Finish	Works With	Head Size
SCR-5625FHZ	Zinc	all piano hinges	#5 x 5/8"
SCR-5625FHB	Black	except PH-*-72SS	#5 x 5/8"
SCR-6625FHZ	Zinc	only PH-*-72SS (stainless steel hole is larger)	#6 x 5/8"

For Our Complete Line Of Screws Please Inquire

72 screws are required per piece.

CABINET HARDWARE

Aluminum Drawer Pulls

Lengths: 12 ft. or Pre-Cut Pieces

Finishes: **S** - Satin/Clear Anodized-Matte Finish **P** - Polished, Shiny/Mirror Finish-Mechanical Polish

3-7/8" Pre-Cut Pieces with 2 Punched Holes

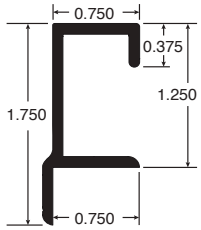

Holes:
 • 1/8" Diameter
 • Approximately 2-5/8" apart
 • Screw Size: #6 (Not Included)

Part #
ALUP1212-S

12' Lengths Without Holes

Part #
ALU1212-S

Fits: 3/4"
Thickness: 0.096



3-7/8" Pre-Cut Pieces with 2 Punched Holes

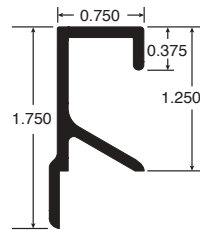

Holes:
 • 1/8" Diameter
 • Approximately 2-5/8" apart
 • Screw Size: #6 (Not Included)

Part #
ALUP1414-S

12' Lengths Without Holes

Part #
ALU1414-S

Fits: 3/4"
Thickness: 0.096



3-7/8" Pre-Cut Pieces with 2 Punched Holes

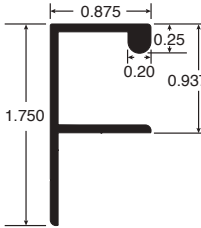

Holes:
 • 1/8" Diameter
 • Approximately 2-5/8" apart
 • Screw Size: #6 (Not Included)

Part #
ALUP1818-S

12' Lengths Without Holes

Part #
ALU1818-S

Fits: 7/8"
Thickness: 0.068



Continuous Aluminum Pull Handles

Lengths: 8 ft.

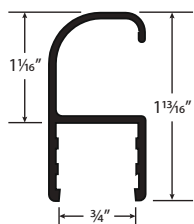

Fits: 3/4"
Thickness: 0.077

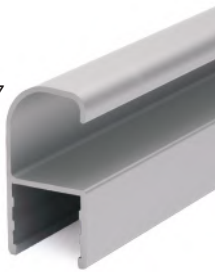

Part # **Finish**
PULL-A750U-S Clear Anodized
PULL-A750U-WH White Powder Coat



Plastic Pull Handles

Lengths: 12 ft. • **Material:** PVC

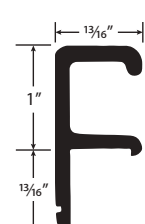

Fits: 5/8"
Thickness: 0.12



Part # **Color**
P3-BK Black
P3-SG Silver Gray

CABINET HARDWARE

Aluminum Drawer Pulls

Lengths: 12 ft.

Finishes: **S** - Satin/Clear Anodized-Matte Finish **P** - Polished, Shiny/Mirror Finish-Mechanical Polish

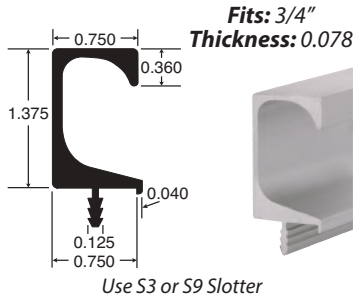

Part # **Finish**
ALU126-S Satin

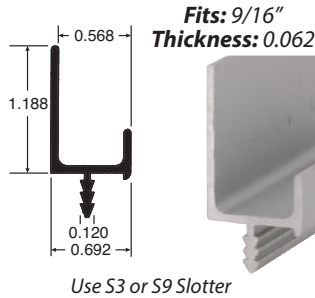

Part # **Finish**
ALU1510-S Satin

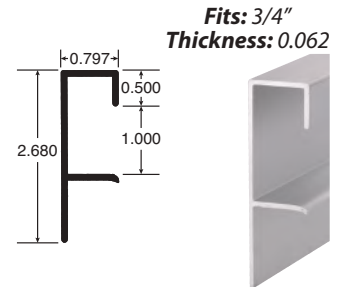

Part # **Finish**
ALU1160-S Satin

Non-stock item. Please Inquire for minimums & lead time.

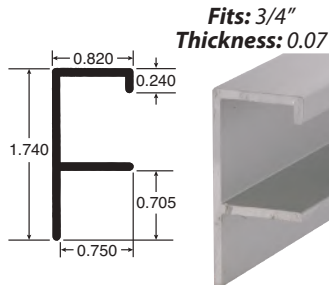

Part # **Finish**
ALU1500H-S Satin

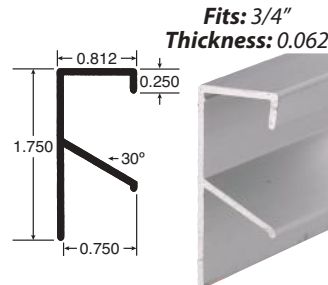

Part # **Finish**
ALU1500T-S Satin

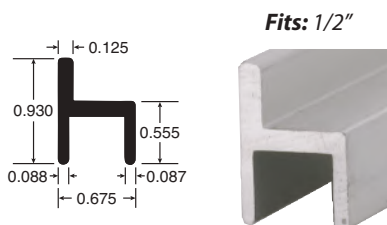

Part # **Finish**
ALU120-S Satin

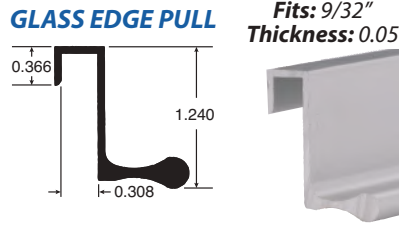

Part # **Finish**
ALU3108-S Satin

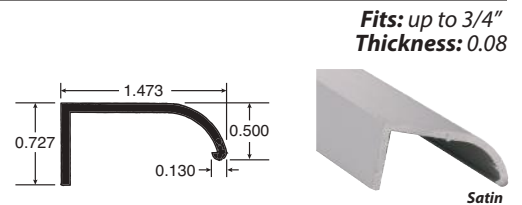

Part # **Finish**
ALU1952-S Satin
ALU1952-BK Black

Lengths: 8 ft.

Fits: 3/4"
Thickness: 0.076

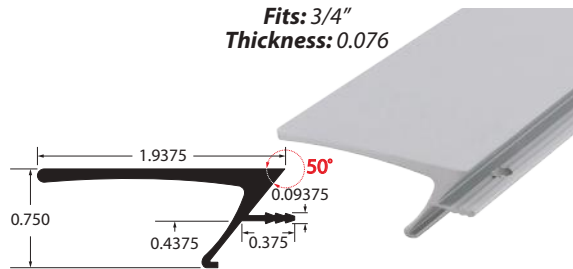

Part # **Finish**
PLX-KL8LA-S Satin

CABINET HARDWARE

Modern Style Pulls

Lengths: 12 ft. or Pre-Cut Pieces

Finishes: **S** - Satin/Clear Anodized-Matte Finish **P** - Polished, Shiny/Mirror Finish-Mechanical Polish

Material: Aluminum

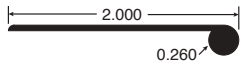

Fits: 3/4"

Thickness: 0.055



1-1/2" Pre-Cut Pieces with 2 Punched Holes

Holes:

- 1/8" Diameter
- Approximately 0.85" apart
- Screw Size: #6 (Not Included)

Part #

ALUP1515-S

Material: Aluminum

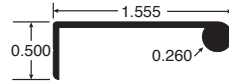

Fits: 3/4"

Thickness: 0.055



1-1/2" Pre-Cut Pieces with 2 Punched Holes

Holes:

- 1/8" Diameter
- Approximately 0.85" apart
- Screw Size: #6 (Not Included)

Part #

ALUP1616-S

ALUP1616-P

12' Lengths Without Holes

Part #

ALU1616-S

Material: Aluminum



Thickness: .087

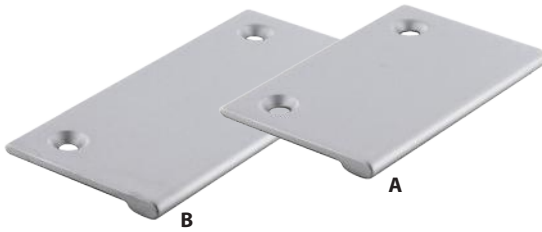

Pre-Cut Pieces with 2 Punched Holes

Countersunk Holes:

- Diameter: 1/8"
- Screw Size: #6 (Not Included)

Material: Aluminum

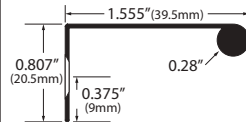

Thickness: .065

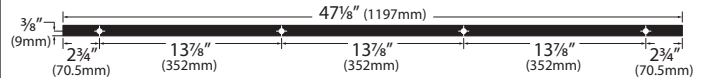
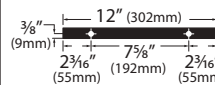

with Punched Holes

Holes:

- Diameter: 3/8" (9mm)
- Screw Size: #6 (Not Included)



Part #

PLX-JL305A-S

Finish

Satin

Length

12"

Holes

2

PLX-JL305A-P

Polished

PLX-JL1200A-S

Satin

47.125"

4

PLX-JL1200A-P

Polished

	Part #	Overall	CC
A	PLM-KT5070A-S	2.75"	2.00" (50mm)
B	PLM-KT7090A-S	3.56"	2.75" (70mm)

FOOT RAIL KITS

FOOT RAIL KIT:

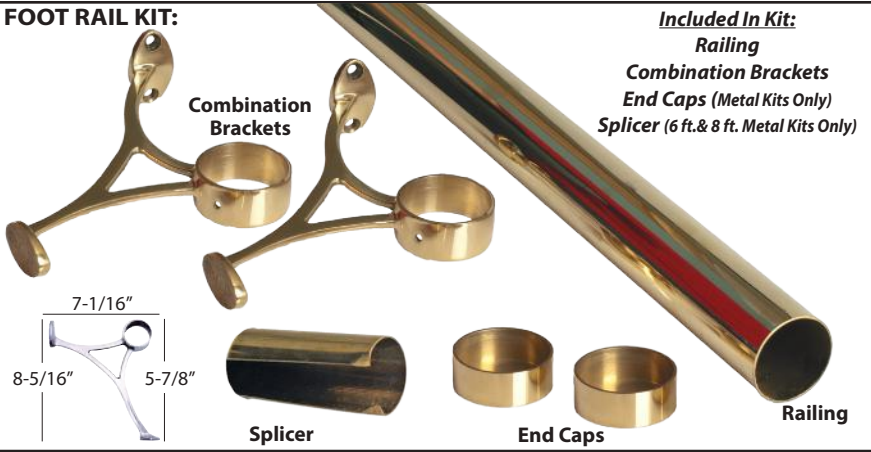

Included In Kit:
 Railing
 Combination Brackets
 End Caps (Metal Kits Only)
 Splicer (6 ft. & 8 ft. Metal Kits Only)



8 HIGH QUALITY FINISHES



2 WOOD FINISHES



*****NOTE*****
 ALL COMPONENTS ARE
 FINISHED BY HAND. IT IS
 POSSIBLE THE PRODUCT
 FINISH WILL VARY FROM
 KIT TO KIT.



Distinctive! Exclusive! Beautiful!

- High quality, commercial grade solid brass, 304 stainless steel, or perfectly doweled wood railing & components that will provide a professional and classic look!
- The railing is extremely durable, with a .050 wall thickness. The wood dowel has a solid core.
- The *Combination Brackets* can be attached to the face of the wall and rest on the floor for added support and stability.
- An *Internal Splicer* is included to joins the rails; simply space the combination bracket over the seam for a sleek look. (6 ft. & 8 ft. Metal kits only)
- *End Caps* included to complete the job! (Metal kits only)
- *Screws* supplied.

NOW AVAILABLE!
12', 16', 20', 24'
LENGTH METAL KITS
 PLEASE INQUIRE

4 FT. Kits (Nominal Lengths)

METAL KITS Include:

- One 4 ft. tube (Nominal) 2" O.D. (.050 Wall Thickness)
- Two combination brackets
- Two end caps

Part #	Rail
S83-200-KIT4-*	Metal

SOLID WOOD KITS Include:

- One 8 ft. tube - 2" O.D. (.050 Wall Thickness)
- Three combination brackets

Part #	Rail
S83-200-K4-OK-*	Solid Oak
S83-200-K4-MP-*	Solid Maple

6 FT. Kits

METAL KITS Includes:

- Two 3 ft. tubes - 2" O.D. (.050 Wall Thickness)
- Three combination brackets
- Two end caps
- One tube splicer

Part #	Rail
S83-200-KIT6-*	Metal

8 FT. Kits (Nominal Lengths)

METAL KITS Include:

- Two 4 ft. tubes (Nominal) 2" O.D. (.050 Wall Thickness)
- Three combination brackets
- Two end caps
- One tube splicer

Part #	Rail
S83-200-KIT8-*	Metal

SOLID WOOD KITS Include:

- One 8 ft. tube - 2" O.D. (.050 Wall Thickness)
- Three combination brackets

Part #	Rail
S83-200-K8-OK-*	Solid Oak
S83-200-K8-MP-*	Solid Maple

ROUND WIRE MANAGEMENT GROMMETS

1 26 Series: USB/iPhone Wire Grommet Sets

Material: ABS



2 27 Series: Round Wire Gripping Grommets

Material: High Impact Styrene



3 31 Series Grommet Sets

Material: ABS



4 35 Series Grommet Sets

Material: ABS



5 36 Series Grommet Sets

Material: ABS



6 Econo Series Grommet Sets w/Textured Cap

Material: ABS

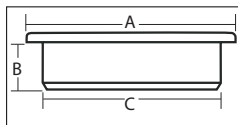
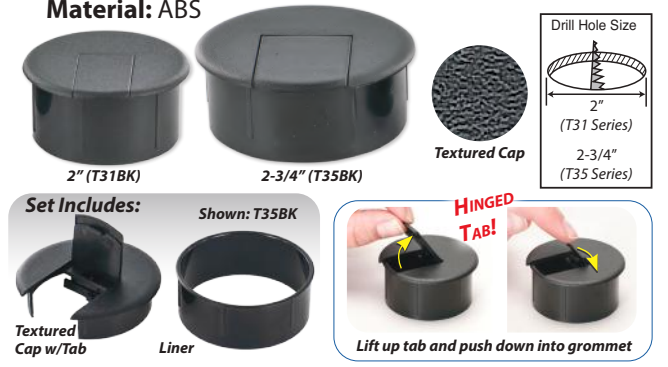

Number	Part #	Color	A	B	C
1	26*	Black (*BK), White (*WH)	1-1/8"	1/2"	1"
2	27*	Brown (*BR), Black (*BK), White (*WH)	1.23"	.295"	1.125"
3	31*	Dove Gray (*DG), Brown (*BR), Black (*BK), Putty (*PT), White (*WH)	2-1/4"	1"	2"
4	35*	Dove Gray (*DG), Brown (*BR), Black (*BK), Putty (*PT), White (*WH)	3"	1-1/8"	2-3/4"
	35BK-LIN	Black Liner (for 35* only)	2-3/4"	1-1/8"	2-3/4"
5	36*	Black (*BK), White (*WH)	3-1/4"	1"	3"
6	T31-BK	Black	2-1/4"	1"	2"
	T35-BK	Black	3"	1"	2-3/4"

OVAL WIRE MANAGEMENT GROMMETS

1 39 Series Grommet Sets

Material: Polystyrene



- Can fit oversized cords
- Can handle multiple cords

Set Includes:

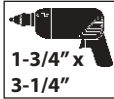

2 OV32 Series Grommet Sets

Material: ABS



- Can close wire cover when not in use
- Can handle multiple cords

Set Includes:

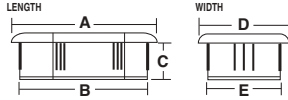
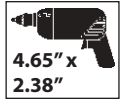

Number	Part #	Color	A	B	C	D	E
1	39*	Black (*BK), White (*WH), Gray (*GR)	3-1/2"	3-1/4"	9/16"	2"	1-3/4"
2	OV32-BK	Black only	5"	4.65"	.98"	2.77"	2.38"

RECTANGULAR WIRE MANAGEMENT & PAPER SLOT GROMMETS

1 32 Series: Wire Grommets

Material: ABS

- Bushings: Deep for wood application, shallow for metal application
- Cap Styles:
Circular opening (-2), Oval (-4)



Set Includes:

Liner

CAP #2
(CIRCULAR)

2-piece Cap



Set Includes:

Liner

Cap

CAP #4
(OVAL)

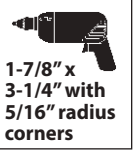

2 33 Series: Paper Slot Grommets

Material: ABS

- 2 insert depths included (3/4"-1-13/16" & 1"-1-1/16")
- Accommodates paper up to 17"

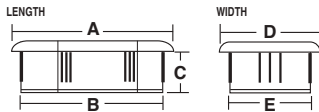
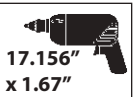

Number	Part #	Cap Style	Color	A	B	C	D	E
1	32BK-2	Oval (-4)	Black	3-1/2"	3-1/4"	5/8"	2"	1-3/4"
	32BK-4	Oval (-4)	Black	3-1/2"	3-1/4"	5/8"	2"	1-3/4"
	32BKD-2	Oval (-4)	Black	3-1/2"	3-1/4"	1-1/4"	2"	1-7/8"
	32BKD-4	Round (-2)	Black	3-1/2"	3-1/4"	1-1/4"	2"	1-7/8"
2	33BK	N/A	Black	17-7/8"	17.156"	13/16"	2-3/8"	1.67"

FLEX SERIES GROMMETS

Material: ABS

- Allows for easy maneuvering of wires



Part #	Color	A	B	C
G31-*	Black (*BK), White (*WH), Beige (*BE),	2.816"	.75"	2.375"
G32-*	Silver Gray (*SG), Almond (*AL), Gray (*GY) Brown (*BR),	3.595"	.75"	3.195"

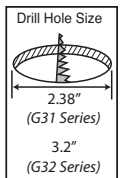
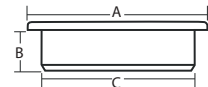

ALL-FIT ADJUSTABLE BUSHING IN BLACK



Material: Nylon

REACH & ROHS
COMPLIANT

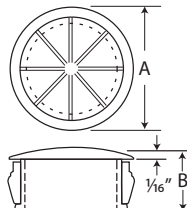

Part #	Hole Diameter	A Head Dia.	B Thickness	Max Wire
AF-0625	5/8"	0.718"	0.406"	0.437"
AF-0750	3/4"	0.859"	0.390"	0.500"
AF-0812	13/16"	0.890"	0.390"	0.500"
AF-0875	7/8"	0.937"	0.453"	0.562"
AF-1000	1"	1.062"	0.453"	0.750"
AF-1093	1-3/32"	1.156"	0.453"	0.812"
AF-1250	1-1/4"	1.360"	0.453"	0.875"

WIRE MANAGEMENT GROMMETS

SPG Series: Spring Loaded Grommet Sets

Material: ABS

- Easy access to wires; simply push down on door & slide left or right
- Cap has one piece construction
- 3 sizes available



Set Includes:



Drill Hole Size

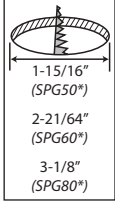

Part #	Color	A	B	C
SPG50-*	Black (*BK)	2-9/16"	13/16"	1-15/16"
SPG60-*	Silver (*SL)	2-13/16"	25/32"	2-21/64"
SPG80-*		3-3/4"	13/16"	3-1/8"

Executive Edge Grommets

Material: Clear Anodized Aluminum

- Hinged cover
- Bristle hair cable management opening

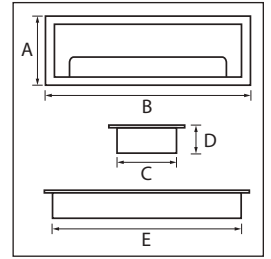

Part #	A	B	C	D	E
E80-160-S	80MM (3-1/8")	160MM (6-5/16")	68MM (2-11/16")	28MM (1-1/8")	148MM (5-13/16")
E80-275-S	80MM (3-1/8")	275MM (10-13/16")	68MM (2-11/16")	28MM (1-1/8")	264MM (10-3/8")

MULTIPURPOSE GROMMETS

Round Grommet with Lid

Material: 304 Stainless Steel

- Self-leveling lid
- Horizontal use only

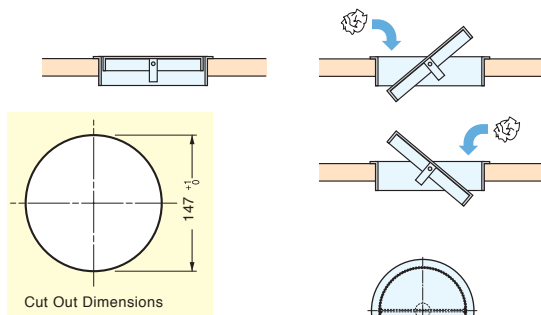

Part #	Finish
AD-DH015	Brushed

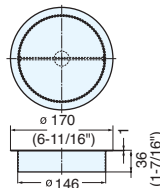

Square Grommet with Lid

Material: 304 Stainless Steel

- Self-leveling lid
- Horizontal use only

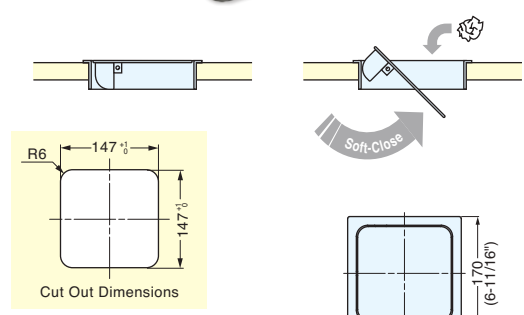

Part #	Finish
AD-KH015-HL	Brushed

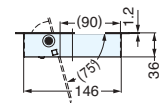

CABLE CLAMPS

NATURAL NYLON



REACH & ROHS
COMPLIANT

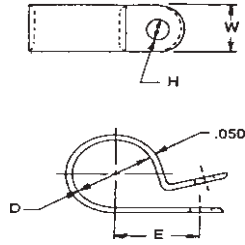

These nylon cable clamps are perfect for applications in electronics, automotive, air craft, appliance and many other industries. The Standard Series has a 3/8" wide contact area and is designed for medium to lightweight applications.

* USE #10 PANHEAD FOR ALL

STANDARD

Part #	D	W	H	E
CC-0187	3/16"	3/8"	.140 (#6)	.430
CC-0250	1/4"	3/8"	.167 (#8)	.410
CC-0312	5/16"	3/8"	.167 (#8)	.495
CC-0375	3/8"	3/8"	.167 (#8)	.595
CC-0500	1/2"	3/8"	.167 (#8)	.605

Larger Sizes Available up to 1-1/2"

HEAVY DUTY

Part #	D	W	H *	E
HDCC-018	3/16"	1/2"	.203	.425
HDCC-025	1/4"	1/2"	.203	.410
HDCC-031	5/16"	1/2"	.203	.500
HDCC-037	3/8"	1/2"	.203	.530
HDCC-050	1/2"	1/2"	.203	.595
HDCC-062	5/8"	1/2"	.203	.655

QUICK RELEASE CABLE CLAMPS

NATURAL NYLON WITH ADHESIVE

These adhesive backed nylon wire & cable clips are used to route wire & cables. The parts are backed with polyurethane foam tape & feature a releasable clip so wires can be removed after assembly if desired.

REACH & ROHS
COMPLIANT

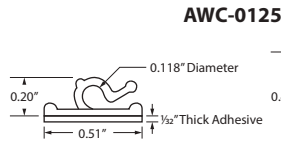

Part #	Size
AWC-0125	1/8"

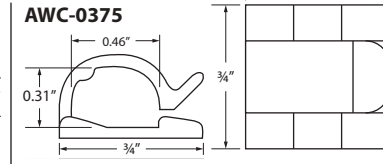

Part #	Size
AWC-0375	3/8"
AWC-0375BK	3/8"

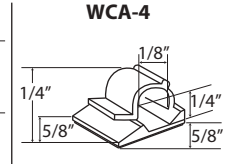

Part #	Size
WCA-4	1/4"

NYLON CABLE TIES

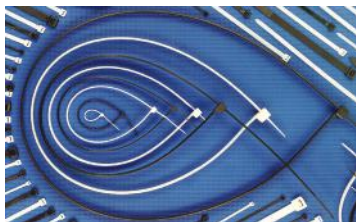

Part #	Color	Length	Bundle Dia. Min - Max	Tensile Strength
NCT-400	Natural	4"	1/16" - 7/8"	18 lbs.
NCT-400BK	Black	4"	1/16" - 7/8"	18 lbs.
NCT-550	Natural	5-1/2"	1/16" - 1-1/4"	40 lbs.
NCT-550BK	Black	5-1/2"	1/16" - 1-1/4"	40 lbs.
NCT-800	Natural	8"	1/16" - 2-1/8"	40 lbs.
NCT-800BK	Black	8"	1/16" - 2-1/8"	40 lbs.
NCT-1500	Natural	15"	1/16" - 4"	50 lbs.
NCT-1500BK	Black	15"	1/16" - 4"	50 lbs.

RACEWAY ON-A ROLL



- Material: PVC - UL94VO Rated - flame retardant
- Folds into a rigid PVC channel for wire or cable installations
- Easy for storage for up to 50 ft. and 100 ft. of raceway
- High quality
- Perfect for around windows and doors
- Adhesive backing for fast-easy installation

	Part #	Description	Inside Dimension
50 FT. COIL	FWF-25511	1/4" White	.255" x .125"
	FWF-25521	1/4" Beige	.255" x .125"
	FWF-14511	3/8" White	.375" x .375"
	FWF-14521	3/8" Beige	.375" x .375"
	FWF-05511	1/2" White	.475" x .475"
	FWF-05521	1/2" Beige	.475" x .475"
100 FT. COIL	FWF-10511	1" White	1.085" x .545"
	FWF-10521	1" Beige	1.085" x .545"
	FWF-14111	3/8" White	.375" x .375"
	FWF-14121	3/8" Beige	.375" x .375"

WIRE MANAGEMENT / TRUNKING CABLE SYSTEM

Wire Hider / Cover Lid

Material: White (*WH) or Clear (*CL) PVC • Lengths: 6 Ft.

- Flexible vinyl flap design that keeps wire in place during installation, ideal for ceiling application
- Solid cover lids (can be latex painted to match decor)
- UL94VO rated
- Adhesive back for easy installation
- Clear color (for visual cable identification)
- Can be used with or without cover lid (*sold separately*)



Wire Hider Cover Lid - White Only

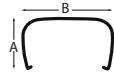

Part #	Description	A	B
CWMC-50-WH	1/2" Wire Cover Lid	.535"	.645"
CWMC-1-WH	1" Wire Cover Lid	.605"	1.225"
CWMC-15-WH	1-1/2" Wire Cover Lid	.875"	1.687"

Wire Hider with pressure sensitive adhesive



Part #	Description	A	B	C
CWMH-50-*	1/2" Wire Cover	.380"	.520"	.375"
CWMH-1-*	1" Wire Cover	.545"	1.085"	.750"
CWMH-15-*	1-1/2" Wire Cover	.687"	1.5"	1.000"

Snap Latching Duct



Material: White PVC • Lengths: 6 Ft.

- Economical one piece latching system
- UL94VO rated
- Latex paintable PVC surface
- Adhesive back for easy installation

With pressure sensitive adhesive

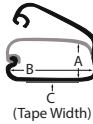

Part #	Description	A	B	C
CWML-50-WH	1/2" Snap Latching Duct	.390"	.475"	.375"
CWML-1-WH	1" Snap Latching Duct	.545"	1.085"	.750"
CWML-15-WH	1-1/2" Snap Latching Duct	.687"	1.5"	.750"

Accessories

Material: White ABS

- Accessories are compatible, fits both Wire Hider and Snap Latching
- UL94VO/5A fire retardant ABS material with a UV stabilizer to prevent color fading

Ceiling Drop



Part #	Size
CD-50-WH	1/2"
CD-1-WH	1"
CD-15-WH	1-1/2"

End Cap



Part #	Size
EC-50-WH	1/2"
EC-1-WH	1"
EC-15-WH	1-1/2"

Inside Corner



Part #	Size
IC-50-WH	1/2"
IC-1-WH	1"
IC-15-WH	1-1/2"

Outside Corner



Part #	Size
OC-50-WH	1/2"
OC-1-WH	1"
OC-15-WH	1-1/2"

Right Angle



Part #	Size
RA-50-WH	1/2"
RA-1-WH	1"
RA-15-WH	1-1/2"

Tee Connector



Part #	Size
T-50-WH	1/2"
T-1-WH	1"
T-15-WH	1-1/2"

Coupler

(Wire Hider Only)



Part #	Size
COU-50-WHW	1/2"
COU-1-WHW	1"
COU-15-WHW	1-1/2"

Coupler

(Latching Only)



Part #	Size
COU-50-LDW	1/2"
COU-1-LDW	1"
COU-15-LDW	1-1/2"



Part #	Size
CWM-FSMEX-WH	1" deep box extender for CWM-FSM
CWM-FSM-WH	1.6" deep single gang surface mount

WIRE MANAGEMENT EXTRUSIONS

Material: Black PVC • Lengths: 8 Ft.

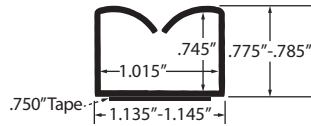

Part #
2243-BK

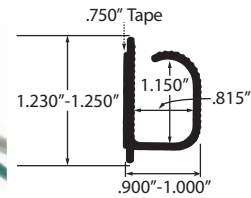

Part #
5200-BK

WIRE MANAGEMENT FOR 2-3/8" (60mm) ROUND TABLE LEGS

Material: Black PVC

Lengths: 5 Ft.
w/Adhesive Back

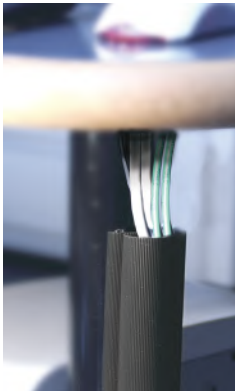
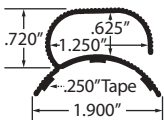

Part #
CWM-1575-BK

WIRE & CABLE ORGANIZATION CHANNEL

Material: Black Virgin Vinyl • Lengths: 8 Ft.



Channels are supplied with self adhesive tape. This product is used to store and organize wire, computer cable, phone/fax lines, electrical cords and other wiring devices on such items as entertainment centers, computer work stations, desks & home theater systems.

OPEN CHANNEL

Part #	A	B	C	D	E	F
CWM15-BK	1.410"	.925"	.753"	1.061"	2.344"	.500"

LOCK CLOSE CHANNEL

Part #	A	B	C	D	E	F
CWM30-BK	.365"	.650"	.143"	.770"	.410"	.625"
CWM50-BK	.474"	.900"	.194"	1.01"	.550"	.750"
CWM10-BK	.750"	1.335"	.242"	1.510"	.770"	1.250"

Open Channel

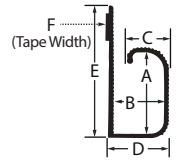

Lock Close Channel

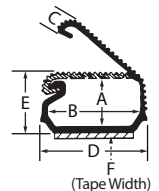

HIDEACORD®

SELF ADHESIVE ELECTRICAL WIRE COVER SYSTEM



- Material: Rigid ABS Plastic
- Lengths : 8 Ft.
- Available In White & Black
(Can Be Painted To Match Wall Colors)
- Accommodates standard household cords

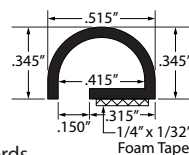

Part#	Description
1300-WH	8 Ft. Wire Cover-White w/Adhesive
1300-BK	8 Ft. Wire Cover-Black w/Adhesive

SLIDE-N-HIDE

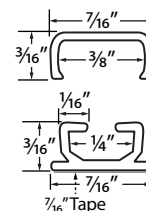

- Material: Polycarbonate
- Finish: White
- Lengths: 18"
- 3M Adhesive
- Conceal a low-voltage cable or wire (Up to 22 gauge wire)
- 1/4" height when assembled

Part#
WM-01-WH

All Inside Dimensions Are Approximate

WE USE ONLY HIGH QUALITY, GENERAL USE ADHESIVE TAPES. EACH CUSTOMER ASSUMES RESPONSIBILITY OF TESTING THE PRODUCT FOR THEIR SPECIFIC APPLICATION. WE WILL SUPPLY SAMPLES FOR THIS PURPOSE. SPECIAL NEEDS CAN BE ACCOMMODATED ON A PER RUN BASIS.

ADJUSTABLE PANEL / GLASS RETAINER



Insert May Be:

- Glass
- Markerboard
- Tackboard
- Expanded Metal Grilles
- Woven Wire Grilles
- Decorative MDF Screening Panel

Lengths: 12 Ft. • Material: RPVC
Accommodates all panels at 1/16", 1/8" & 1/4"

Colors Available

*LB - Light Beige *FW - Frost White *PLT - Platinum
unless otherwise noted

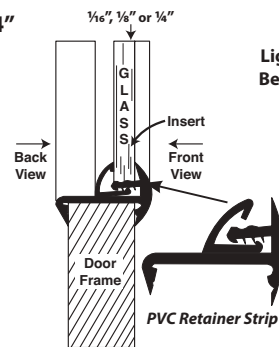
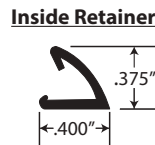
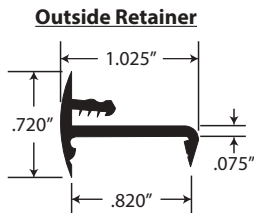

SOLD IN SETS
Part #
6500*

PANEL RETAINER

Lengths: 100 Ft. / 500 Ft. Coils • Material: Vinyl

Colors Available

*WH - White *BK - Black *BR - Brown
unless otherwise noted

Staple Type

Part # 102-625*	Part # 102-680*	Part # 102-627*	Part # 102-681*	Part # 102-645*
Part # 102-698*	Part # 102-644*	Part # 102-778*	Part # 102-623*	Part # 102-624*
Part # 102-620*	Part # 102-646-BR	Part # 102-621*		

Groove Type

Use S4 or S10 Slotter

"A" SHAPE BEFORE INSERTION
FRAME
TO GAUGE
130-145

"B" SHAPE AFTER INSERTION
Also Available
In Fruitwood
& Clear

Part #
102-621*

GLASS / PANEL RETAINING BUTTONS

Material: Color: P.E. Plastic • Clear: Lexan Plastic
Screws sold separately

Flush

R21-10BE Beige
R21-10BK Black
R21-10CL Clear

R21-183BE Beige

SCR-5625FHZ #5 x 5/8" Flat Head Zinc Screw

R21-180CL Clear

SCR-6625PHZ #6 x 5/8" Pan Head Zinc Screw

R21-183BE Beige

SCR-6625FHZ #6 x 5/8" Flat Head Zinc Screw

Recessed

For semi-permanent installations

R21-281DB Dk. Brown 5/16"
R21-281CL Clear 5/16"
R21-313CL Clear 1/8"

SCR-6625FHZ #6 x 5/8" Flat Head Zinc Screw

Grille Panel Retainers

BRONZE FINISH ON STEEL
Overall Size: 3/8" wide x 1-3/16" long • Screws included

- Screw adjustable, secure holding & quick removal of metal grilles.
- Reversible to accommodate varied glass thicknesses and door mortises.
- 7/8" vinyl tipped screw tightens and adjusts without harming glass.

SH-302

No-Route Glass/Panel Retaining Clips

- Color: Brown
- Designed to attach glass or decorative panels to doors without routing
- Can be screwed or stapled in place
- Available for 1/8" or 3/16" thick panels

Part #	Material Thickness
R21-1804BR	1/8"
R21-1805BR	3/16"

R21-1804BR
R21-1805BR

Mirror Clip

Designed to attach mirrors, glass, decorative panels, etc. to any flat surface

- Made of crystal styrene, ribbed
- Fits 1/4" glass thickness

R45-293CL Clear

SCR-5625FHZ #5 x 5/8" Flat Head Zinc Screw

FIXTURE & WALL BUMPER

2" Stainless Steel Bumper

Material: 304 Stainless Steel

Finish: Brushed Stainless Steel Top/Black Poly Carbonate Base

- Clean seamless contemporary look with end caps and corners
- Installs easily with a saw to cut to size, drill and screwdriver
- Impacts are absorbed and distributed along the length and to the polycarbonate base
- Popular 2" wide x 12 ft lengths
- Easy to maintain

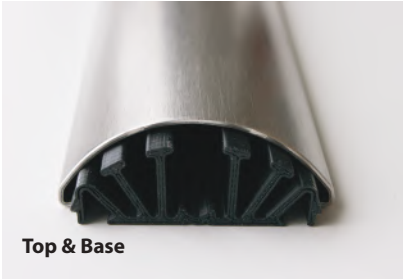

Top & Base



Corner



End Cap



Part #	Description
SST-20	SS Top
SSB-20	PC Base

Part #	Description
SSE-20	SS End Cap
SSC-20	SS Corner

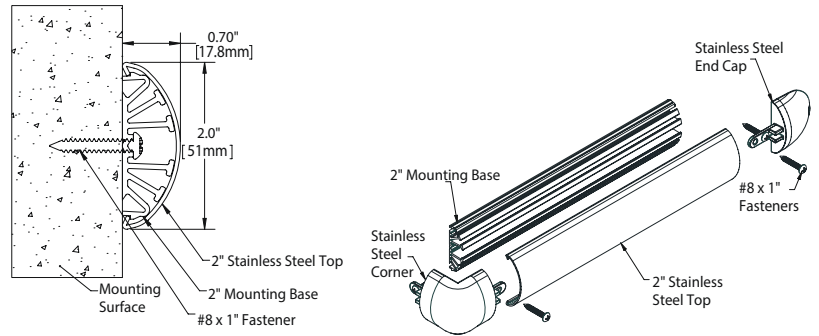

FIXTURE & WALL BUMPER

- Profile matches CartGuard1 for seamless transition from rigid to flexible products.
- Made from a minimum of 91% pre consumer polycarbonate waste.
- Contributes towards satisfying MR CREDIT 4-1 and MR CREDIT 4-2 under Leed.
- Exceeds Impact performance of High Impact PVC by 29% and ABS by 63%.
- 100% recyclable. Laser etched recycling symbol and resin ID code.
- 100% Chlorine free (PVC free, vinyl free)
- Does not emit hazardous dioxins if incinerated during waste disposal.



1" Polycarbonate Bumper [PVC Base]

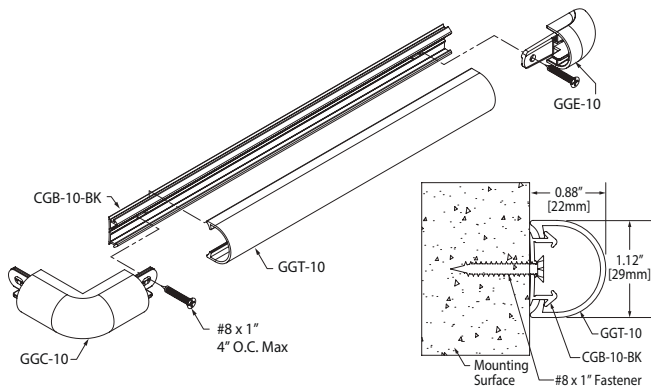

Part #	Description	Material	Length
GGT-10-*	1" Top	Polycarbonate	12'
CGB-10-BK	1" Base	PVC	12'

Part #	Description	Material
GGE-10-*	1" End Cap	Polycarbonate
GGC-10-*	1" Corner	Polycarbonate

***STOCK COLORS:**

Black PMS Black Hussmann 701, Kysor 85	Silver PMS 877C	Gray PMS 430C Hussmann 054	Steel PMS 425C	Red PMS 1797C Hussmann 715, Kysor 161
Brown PMS 1545C	Putty PMS 452C Hussmann 078, Kysor 121	Light Caramel PMS 465C	Beige PMS 4685C	White PMS White Hussmann 700, Kysor 171

2" Polycarbonate Bumper [PVC Base]

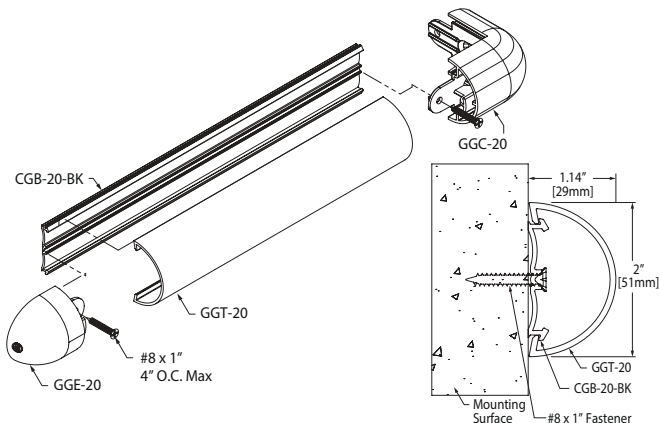

Part #	Description	Material	Length
GGT-20-*	2" Top	Polycarbonate	12'
CGB-20-BK	2" Base	PVC	12'

Part #	Description	Material
GGE-20-*	2" End Cap	Polycarbonate
GGC-20-*	2" Corner	Polycarbonate

***STOCK COLORS:**

Black PMS Black Hussmann 701, Kysor 85	Silver PMS 877C	Gray PMS 430C Hussmann 054	Steel PMS 425C	Red PMS 1797C Hussmann 715, Kysor 161
Brown PMS 1545C	Putty PMS 452C Hussmann 078, Kysor 121	Light Caramel PMS 465C	Blue PMS 293C	

Other colors are special order, minimums apply.

FIXTURE & WALL BUMPER

Flexible

CartGuard1

CartGuard2

- Made from flexible PVC
- Works with GreenGuard1 for smooth seamless transitions
- Designed to wrap around curved fixtures and cases
- Can complete a radius as small as 4"



1" PVC Dual Durometer Bumper [PVC Base]

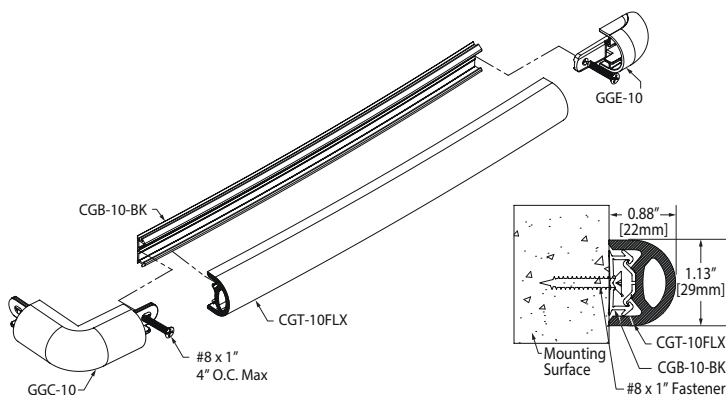

Part #	Description	Material	Length
CGT-10FLX-*	1" Top	PVC Dual Durometer	72'
CGB-10-BK	1" Base	PVC	12'

NOTE: Min order for flexible is 12 ft. and must be ordered in 12 ft. increments

Part #	Description	Material
GGE-10-*	1" End Cap	Polycarbonate
GGC-10-*	1" Corner	Polycarbonate

***STOCK COLORS:**

Black PMS Black Hussmann 701, Kysor 85	Silver PMS 877C	Gray PMS 430C Hussmann 054	Red PMS 1797C Hussmann 715, Kysor 161
Brown PMS 1545C	Beige PMS 4685C		

2" PVC Dual Durometer Bumper [PVC Base]

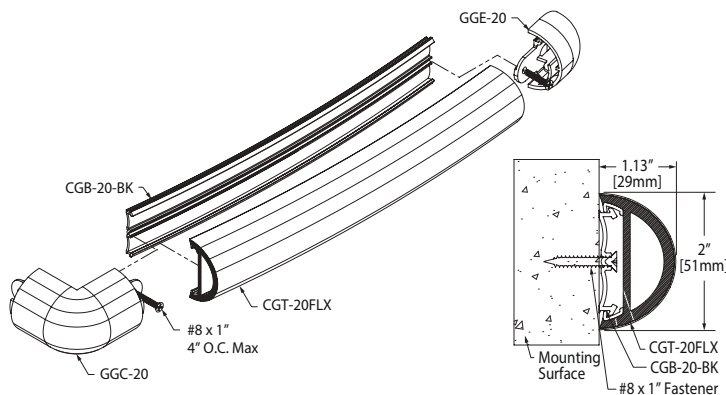

Part #	Description	Material	Length
CGT-20FLX-*	2" Top	PVC Dual Durometer	72'
CGB-20-BK	2" Base	PVC	12'

NOTE: Min order for flexible is 12 ft. and must be ordered in 12 ft. increments

Part #	Description	Material
GGE-20-*	2" End Cap	Polycarbonate
GGC-20-*	2" Corner	Polycarbonate

***STOCK COLORS:**

Black PMS Black Hussmann 701, Kysor 85	Silver PMS 877C	Gray PMS 430C Hussmann 054	Steel PMS 425C
Green PMS 348C	Light Caramel PMS 465C	Beige PMS 4685C	

Other colors are special order, minimums apply.

FIXTURE & WALL BUMPER

2" EDGE Low Profile Bumper Guard

- New modern design
- Made from polycarbonate - **Proformance** is better (exceeds) PVC or ABS competitors.
- Modular design allows for easy installation.

RIGID

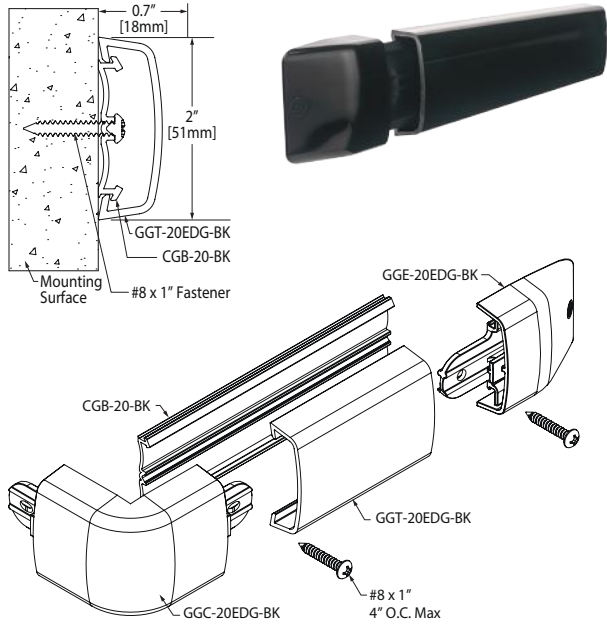

Part #	Description	Material	Length
GGT-20EDG-BK	3" Rigid Top	Polycarbonate	12'
CGB-20-BK	2" Universal Top	PVC	12'

Part #	Description	Material
GGE-20EDG-BK	2" End Cap	Polycarbonate
GGC-20EDG-BK	2" Corner	Polycarbonate

Color matching available, allow 4-8 weeks.

3" Polycarbonate Bumper [PVC Base]

- Damage protection for fixtures, merchandisers, walls and vestibules.
- Decorative ribbing helps hide scuff marks

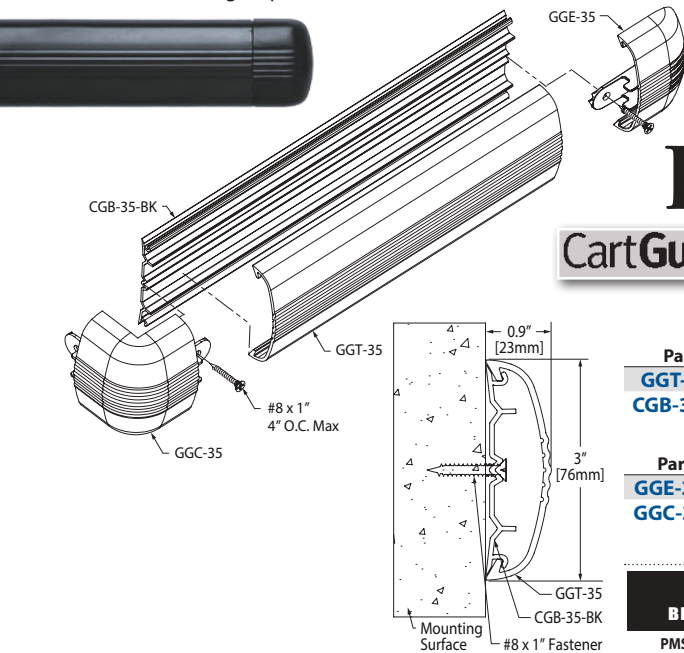

RIGID

CartGuard35



Part #	Description	Material	Length
GGT-35*	3" Top	Polycarbonate	12'
CGB-35-BK	3" Base	PVC	12'

Part #	Description	Material
GGE-35*	3" End Cap	Polycarbonate
GGC-35*	3" Corner	Polycarbonate

*STOCK COLORS:

Black	Silver	Gray	Red	Brown	Beige
PMS Black Hussmann 701, Kysor 85	PMS 877C	PMS 430C Hussmann 054	PMS 1797C Hussmann 715, Kysor 161	PMS 1545C	PMS 4685C

Other colors are special order, minimums apply.

IMPACT PROTECTION SYSTEM

Impact Protection can be found in a variety of settings, from hospitals and nursing homes, to colleges, offices, casinos, hotels and warehouses. Handrails, wall guards, corner guards and door/frame protection come in a multitude of colors, profiles and materials. Choose from stainless steel, aluminum, wood, PVC or combinations of materials to match the protection level your environment requires while at the same time complementing décor.

PRIMARY COLOR PALETTE

Add appropriate color code to part number.

PROMPT PRIMARY COLORS Prompt Primary colors do not apply to all products. Please refer to individual parts for inclusion.

Usually stocked for immediate shipment

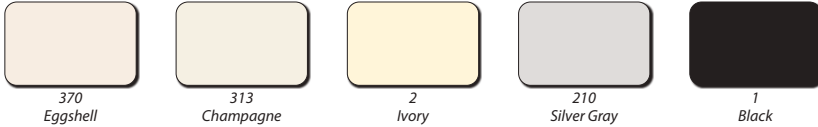

Typically ships within 1 week



STANDARD PRIMARY COLORS Typically ships within 3-4 weeks



Custom Colors - 500 ft. minimum order for color matching. Color & setup charges are on a per run basis. Please inquire.

Installation - Normally with screws, molly bolts or toggle bolts. Most sold separately.

NOTE: Due to fading, discoloration & paper aging, the colors on this page may vary from the actual colors. Please request samples before placing your order for color accuracy.



IMPACT PROTECTION SYSTEM

Handrails

FOR COLORS SEE PAGE 95

MATERIAL: Textured Vinyl with Aluminum Retainer
CLASS A FIRE RATED

BR-500-



A universal handrail for all applications, provides medium to heavy duty protection. Available in full color pallet and is a **prompt primary color**.

Protection Level: Medium-Heavy

	Part #
Handrail:	BR-500-
Bracket:	BR-107-
Return:	BRL-527-
(Left/Right)	BRR-527-
Corner:	IOC-557-
(In/Out)	
Splice:	SPL-500-

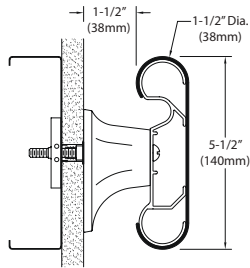

Bracket does not include hardware. Returns, corners & splicers include hardware.

BR-1200-



Traditionally Designed 1-1/2" handrail for a good power grip. Provides function, durability and affordability with medium duty protection. Available in full color pallet and is a **prompt primary color**.

Protection Level: Medium

	Part #
Handrail:	BR-1200-
Bracket:	BR-1206-
Return:	BRL-1225-
(Left/Right)	BRR-1225-
Corner:	IOC-1250-
(In/Out)	
Splice:	SPL-1200-

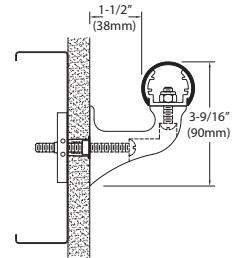

Bracket does not include hardware. Returns, corners & splicers include hardware.

Wall Guards

MATERIAL: Textured Vinyl with Aluminum Retainer
LENGTHS: 12 Ft.

CLASS A FIRE RATED

Accessories: Molded PVC end caps and outside corners are available.

Select profiles offer an accent strip, continuous cushioned bumper and inside corner. Please inquire.

WG-3-



Versatile wall guard can be used as a wainscot cap, chair rail or crash rail. Provides medium duty protection. Available in full color pallet.

Protection Level: Medium

	Part #
Wall Guard:	WG-3-
End Cap:	ETC-3-
Corner:	OTC-3-

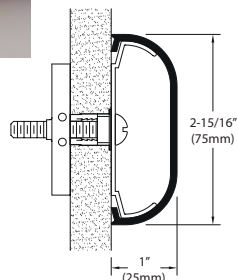

WG-4-



Unique design lets this wall guard work as a chair rail or crash rail. Provides medium duty protection. Available in full color pallet and is a **prompt primary color**.

Protection Level: Medium

	Part #
Wall Guard:	WG-4-
End Cap:	ECL-4-
(Left/Right)	ECR-4-
Corner:	OTC-4-

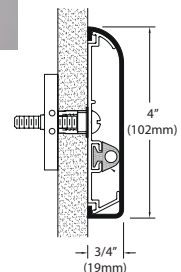

IMPACT PROTECTION SYSTEM

FOR COLORS SEE PAGE 95

Wall Guards

MATERIAL: Textured Vinyl with Aluminum Retainer

LENGTHS: 12 Ft.

CLASS A FIRE RATED

Accessories: Molded PVC end caps and outside corners are available. Select profiles offer an accent strip, continuous cushioned bumper and inside corner. Please inquire.

WG-5-



A Crescent® Series wall guard offers a fresh alternative to traditional rectangular designs. Provides medium to heavy duty protection. Available in the **Red-E-Clip** design for cost savings. Available in full color pallet.

Protection Level: Medium-Heavy

Part #
Wall Guard: WG-5-
End Cap: ETC-5-
Corner: OTC-5- (In/Out) ITC-5-

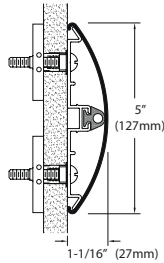

WG-5C- with Red-E-Clip Design

WG-5C comes with 10 Red-E-Clips per 12 ft. length. Clips priced separately if more are needed for installation.

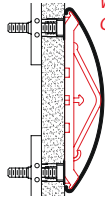

Part #
Wall Guard: WG-5C-
End Cap: ETC-5C-
Corner: OTC-5C- (In/Out) ITC-5C-
Red-E-Clip: WG-5C-ASM

WG-6-

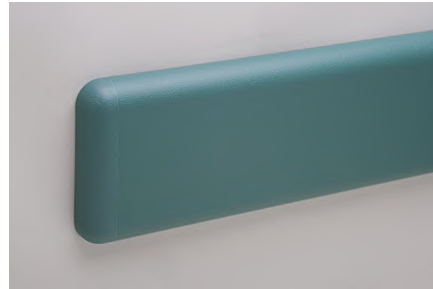

Wider designed wall gives greater protection. Works with the BR-500 handrail for a coordinated design. Provides medium to heavy duty protection. Available in the **Red-E-Clip** design for cost savings. Available in full color pallet and is a **prompt primary color**.

Protection Level: Medium-Heavy

Part #
Wall Guard: WG-6-
End Cap: ETC-6-
Corner: OTC-6-

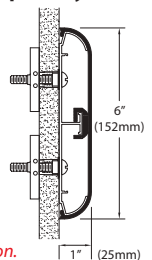

WG-6C- with Red-E-Clip Design

WG-6C comes with 10 Red-E-Clips per 12 ft. length. Clips priced separately if more are needed for installation.

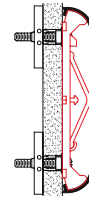

Part #
Wall Guard: WG-6C-
End Cap: ETC-6C-
Corner: OTC-6C-
Red-E-Clip: WG-6C-ASM

WG-7-



Widest Crescent® Series wall guard for maximum protection. Provides medium to heavy duty protection. Available in the **Red-E-Clip** design for cost savings. Available in full color pallet.

Protection Level: Medium-Heavy

Part #
Wall Guard: WG-7-
End Cap: ETC-7-
Corner: OTC-7- (In/Out) ITC-7-

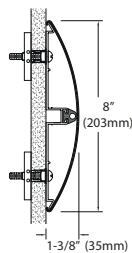

WG-7C- with Red-E-Clip Design

WG-7C comes with 10 Red-E-Clips per 12 ft. length. Clips priced separately if more are needed for installation.

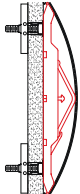

Part #
Wall Guard: WG-7C-
End Cap: ETC-7C-
Corner: OTC-7C- (In/Out) ITC-7C-
Red-E-Clip: WG-7C-ASM

WG-8-



Most popular product for wide area applications. Provides heavy duty protection. Available in the **Red-E-Clip** design for cost savings. Available in full color pallet and is a **prompt primary color**.

Protection Level: Heavy

Part #
Wall Guard: WG-8-
End Cap: ETC-8-
Corner: OTC-8-

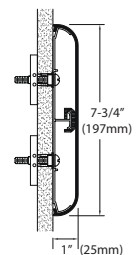

WG-8C- with Red-E-Clip Design

WG-8C comes with 10 Red-E-Clips per 12 ft. length. Clips priced separately if more are needed for installation.

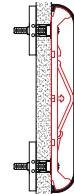

Part #
Wall Guard: WG-8C-
End Cap: ETC-8C-
Corner: OTC-8C-
Red-E-Clip: WG-8C-ASM

IMPACT PROTECTION SYSTEM

FOR COLORS SEE PAGE 95

Wall Guards: Accent Rails

MATERIAL: High Impact PVC Cover with Aluminum Retainer

LENGTHS: 12 Ft.

CLASS A FIRE RATED

Molded PVC end caps and outside corners are available. Suggested to mount to every other stud, approximately 32".

EB-25-



Small simple rounded profile designed to protect walls, cashier stands or nurse stations. Provides medium duty protection. Available in full color pallet.

Protection Level: Medium

	Part #
Wall Guard:	EB-25-
End Cap:	EB-26-
Corner:	EB-27-

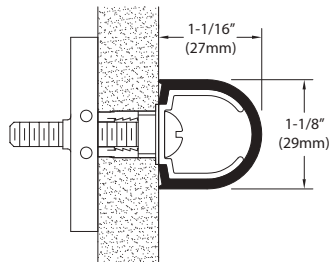

EBR-30-



Low projection, versatile profile used as a chair rail, bumper rail or accent strip. Textured finish. Provides medium duty protection. Available in full color pallet.

Protection Level: Medium

	Part #
Wall Guard:	EBR-30-
End Cap:	EB-31-
Corner:	EB-32-

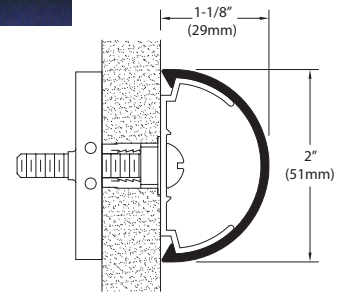

Wall Guards

MATERIAL: Clear Polycarbonate

LENGTHS: 8 Ft.

UL 94 V-2 FLAMMABILITY

Suggested to mount to every other stud, approximately 32".

CR-3-, CR-4-

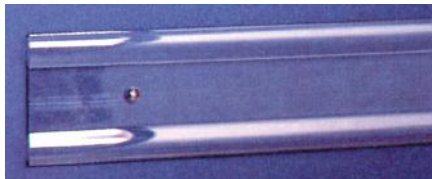

Clear polycarbonate rub rail melds with decor while offering complete protection. Provides medium duty protection.

Protection Level: Medium

Part #	Size
CR-3-132	3" x 8 ft.
CR-4-132	4" x 8 ft.

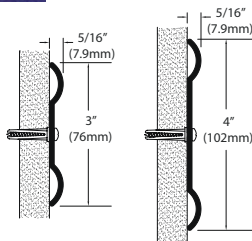

Molded Corner Bumper

MATERIAL: Molded Flexible Vinyl • 8" Corner

CLASS A FIRE RATED

Good for low temperature environments. Excellent abrasion resistance. Not to be used where temperatures exceed 150°F.

Available in Black & Tan Only

EB-8



Smooth Finish

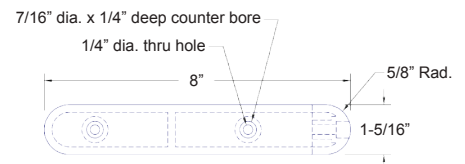
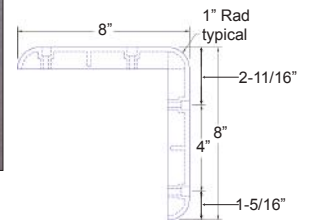

Part #
EB-8-

IMPACT PROTECTION SYSTEM

Wall Coverings

FOR COLORS SEE PAGE 95

CRU-44-, CRU-46- (0.040" Thickness) **CRU-64-, CRU-66-** (0.060" Thickness)



MATERIAL: High Impact Textured Rigid Vinyl
CLASS A FIRE RATED

4" or 6" wide x 8 ft. length rub rail.
Use as a contrast or companion to your wall protection or decor.
Applied with double stick tape, construction adhesive or screws.
Provides medium duty protection.
Available in full color pallet.

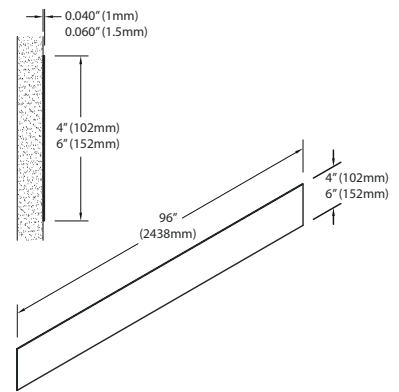

Protection Level: Medium

UNDRILLED ready for installation with double sided tape, construction adhesive or drilling for screws.

Part #	Thickness	Size
CRU-44-	0.040"	4" W x 8 ft.
CRU-46-		6" W x 8 ft.

Part #	Thickness	Size
CRU-64-	0.060"	4" W x 8 ft.
CRU-66-		6" W x 8 ft.

WC-40-

MATERIAL: High Impact Textured Rigid Vinyl

LENGTHS: 8 Ft.

CLASS A FIRE RATED

Wall covering panels for a broad range of applications. Wainscoting, backsplashes, full walls and back rooms can be protected. Works with all wall guards and corner guards to give a complete design for your job. Standard panels are 4 ft. x 8 ft. x 0.040" thick. A line of accessory moulding to finish your job available. Available in full color pallet. Other panel sizes and thickness are available for special order, please inquire.

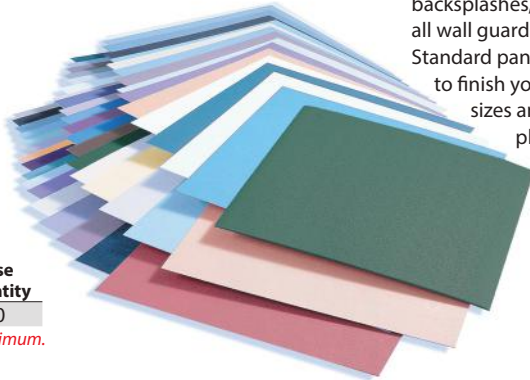

Part #	Size	Case Quantity
WC-40-	4 ft x 8 ft.	20

Available in all 66 colors, no minimum.

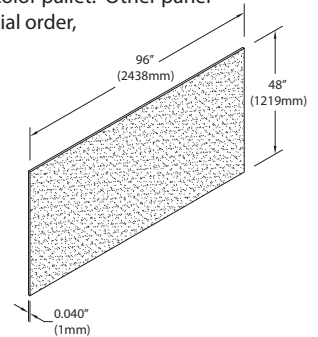

Accessory Mouldings for Wall Covering

FOR COLORS SEE PAGE 95

MATERIAL: Vinyl

CLASS A FIRE RATED

LENGTHS: 8 Ft.



WC-98- Top Cap

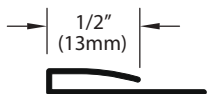

WC-99- Joint Corner

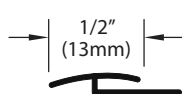

WC-100- Inside Corner

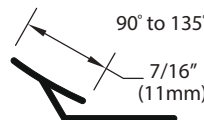

WC-101- Outside Corner

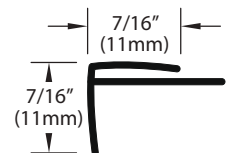

IMPACT PROTECTION SYSTEM

Corner Guards

FOR COLORS SEE PAGE 95

MATERIAL: Textured Vinyl Cover with Aluminum Retainer
CLASS A FIRE RATING

CG-10-

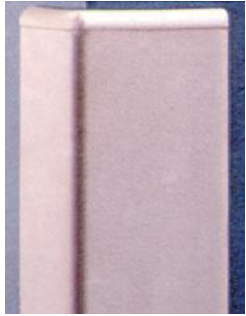

90° surface mounted corner guard with 3" wings, is the widest protection of our vinyl covered aluminum corner guards giving maximum protection. Comes in 4 ft., 8 ft. or 9 ft. lengths. Tops caps are available for a finished look. Provides medium to heavy duty protection. Available in full color pallet and is a **prompt primary color**.

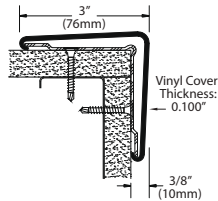

Protection Level: Medium-Heavy

Part #	Length [^]	Top Cap
CG-10-**-4	4 ft.	
CG-10-**-8	8 ft.	TC-10-**-**
CG-10-**-9	9 ft.	

[^] 10 Ft. & 12 Ft. lengths are available - please inquire

CG-20-



90° surface mounted corner guard with 2" wings, is for areas with less traffic or to blend in easily with your decor. Comes in 4 ft., 8 ft. or 9 ft. lengths. Tops caps are available for a finished look. Provides medium to heavy duty protection. Available in full color pallet and is a **prompt primary color**.

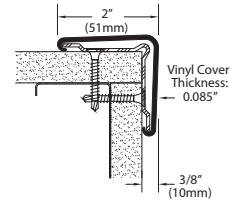

Protection Level: Medium-Heavy

Part #	Length [^]	Top Cap
CG-20-**-4	4 ft.	
CG-20-**-8	8 ft.	TC-20-**-**
CG-20-**-9	9 ft.	

[^] 10 Ft. & 12 Ft. lengths are available - please inquire

CG-12-, CG-13-, CG-14-, CG-34-

MATERIAL: Textured Vinyl Cover, Available with or without Peel & Stick Adhesive
 Drilled options available, *please inquire*

CLASS A FIRE RATING

Protection Level: Medium-Heavy

Angle: 90°

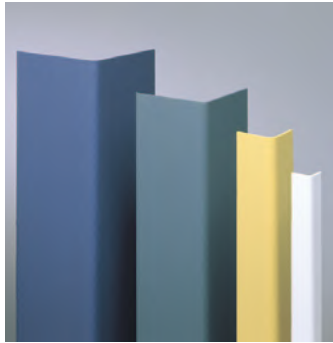

Rigid vinyl 90° corner guards come in wing widths from 3/4" to 4". Installed with either applied double sided adhesive tape, construction adhesive or mechanical fasteners. Very cost effective. Comes in 4 ft., 8 ft. or 12 ft. lengths. Provides medium duty protection. Available in full color pallet. **CG*-12 is a prompt primary color**.

WITH ADHESIVE

Part #	Length	Wing Dimension "A"	Vinyl Cover Thickness Dimension "B"	Radius Dimension "C"	Overall Projection Dimension "D"
CGT-34-**-4	4 ft.	3/4"	.080"	1/8"	.080"
CGT-34-**-8	8 ft.				
CGT-34-**-12	12 ft.				
CGT-12-**-4	4 ft.	1-1/2"	.080"	1/8"	.080"
CGT-12-**-8	8 ft.				
CGT-12-**-12	12 ft.				
CGT-13-**-4	4 ft.	3"	.093"	3/16"	.093"
CGT-13-**-8	8 ft.				
CGT-13-**-12	12 ft.				
CGT-14-**-4	4 ft.	4"	.093"	3/16"	.093"
CGT-14-**-8	8 ft.				
CGT-14-**-12	12 ft.				

WITHOUT ADHESIVE

Part #	Length	Wing Dimension "A"	Vinyl Cover Thickness Dimension "B"	Radius Dimension "C"	Overall Projection Dimension "D"
CGU-34-**-4	4 ft.	3/4"	.080"	1/8"	.080"
CGU-34-**-8	8 ft.				
CGU-34-**-12	12 ft.				
CGU-12-**-4	4 ft.	1-1/2"	.080"	1/8"	.080"
CGU-12-**-8	8 ft.				
CGU-12-**-12	12 ft.				
CGU-13-**-4	4 ft.	3"	.093"	3/16"	.093"
CGU-13-**-8	8 ft.				
CGU-13-**-12	12 ft.				
CGU-14-**-4	4 ft.	4"	.093"	3/16"	.093"
CGU-14-**-8	8 ft.				
CGU-14-**-12	12 ft.				

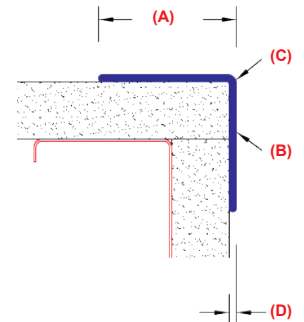

IMPACT PROTECTION SYSTEM

Clear Polycarbonate Corner Guard

MATERIAL: Clear Polycarbonate

UL 94 V-2 FLAMMABILITY

The CG-16 is un-drilled and comes with brad nails. All other profiles are drilled with countersunk holes and include #6 x 1" oval head sheet metal screws.

Protection Level: Medium

Clear polycarbonate corner guards come in wing widths from 3/4" to 3-1/2" and angles for every need. Installed with supplied mechanical fasteners, double sided adhesive tape or construction adhesive. Clear color allows your decor to show through. Tape option is available as special order. Comes in 4 ft. or 8 ft. lengths. Provides medium duty protection.

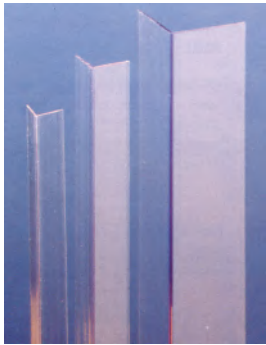
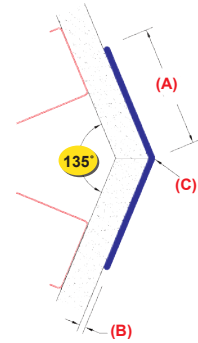
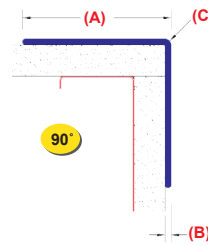

Part #	Length	Angle	Wing Dimension "A"	Cover Thickness Dimension "B"	Radius Dimension "C"
CG-16-132-	4 = 4 ft.	90°	3/4"	.050"	1/16"
*CG-17-132-			1-1/8"	.075"	1/8"
CG-24-132-	2"		.085"	1/8"	
*CG-18-132-	8 = 8 ft.		2-1/2"	.100"	1/8"
CG-25-132-		3"	.110"	1/8"	
CG-19-132-		2-1/2"	.100"	1/8"	
		135°			

* Standard Stocked Product



#4 Satin Finish 304 Grade Stainless Steel Corner Guard

CLASS A FIRE RATING

Ideal for lab and/or foot service environments!

Installs easily with adhesive (*sold separately*). Drilled options available, *please inquire*.

Protection Level: Heavy

Stainless steel corner guards in 304 Stainless with #4 Satin finish. Comes in a variety of wing sizes from 1" to 3-1/2" with choice of corner radii and angles. Installed with construction adhesive or mechanical fasteners. Ends are tapered for close-hugging look when installed. Comes in 4 ft. or 8 ft. lengths. Provides heavy duty protection.

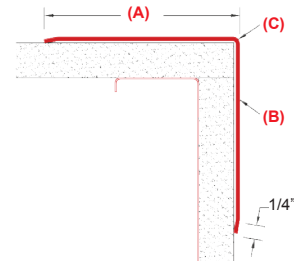

Part #	Length	Angle	Wing Dimension "A"	Vinyl Cover Thickness Dimension "B"	Radius Dimension "C"	
*CG-50-4	4 ft.	90°	3-1/2"	16 GA. (.059")	1/8"	
*CG-50-8	8 ft.		2"			
*CG-51-4	4 ft.					1"
*CG-51-8	8 ft.		3-1/2"		3/4"	
CG-52-4	4 ft.					135°
CG-52-8	8 ft.		3-1/2"		3/4"	
CG-55-4	4 ft.	135°		3-1/2"		1/8"
CG-55-8	8 ft.		3-1/2"		3/4"	
CG-60-4	4 ft.	135°		3-1/2"		1/8"
CG-60-8	8 ft.		3-1/2"		3/4"	
CG-65-4	4 ft.	135°		3-1/2"		1/8"
CG-65-8	8 ft.		3-1/2"		3/4"	

* Standard Stocked Product



OVAL STEEL CLOSET ROD & HARDWARE

Steel Oval 1-1/8" x 9/16" (30mm x 15mm) Closet Rod Tubing



- Eight foot lengths
- Wall thickness 3/64"
- Polished chrome finish
- Use #6 flathead screws

S84-320-8

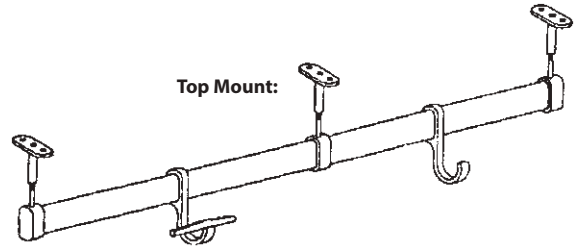

1-1/8" x 9/16" (30mm x 15mm) Fittings

S84-160
Hook



S84-161
Hook
With Bar



S84-250
Ceiling Bracket
End
(Adj. Height)
1-3/4" Base

3-1/4" Closed
4-1/4" Opened



S84-260
Ceiling Bracket
Center
(Adj. Height)
1-3/4" Base

3-1/4" Closed
4-1/4" Opened



S84-3015CS-BC
Projection - 3"



S84-190
Wall Bracket Center
Projection - 3-3/4"



S84-170
Wall Bracket Right End
Projection - 3-3/4"



S84-180
Wall Bracket Left End
Projection - 3-3/4"



S84-802NP
Nickel
Standard
Closet Rod Support
Screw Type



S84-E3015S
Zinc
Economy
Closet Rod Support
Screw Type



S84-E320NP
Chrome
Economy
Closet Rod Support
Pin Type



5/8" ROUND STEEL CLOSET ROD & HARDWARE

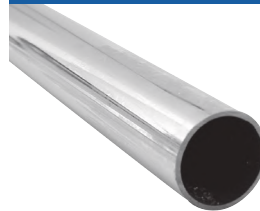

A1BC
4 Ft. Long Closet Rod



S84-803NP

- U-Flange for 5mm hole
- Nickel Closet Rod Support 32mm System
- Pin type

For more tubing, see page 107

OVAL & ROUND ALUMINUM CLOSET ROD & HARDWARE

Aluminum Oval 1-3/16 x 19/32" Closet Rod

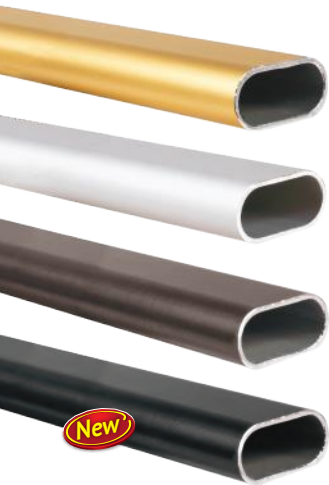

- Eight foot lengths
- Wall thickness 1/16"

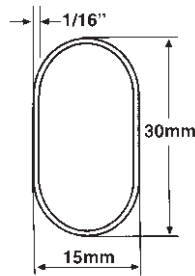

Part #	Finish
S84-3015-SB	Satin Brass
S84-3015-SC	Satin Chrome
S84-3015-ORB	Oil Rubbed Bronze
S84-3015-BK	Black

Oval Closet Rod Supports for 19/32" Oval Closet Rod

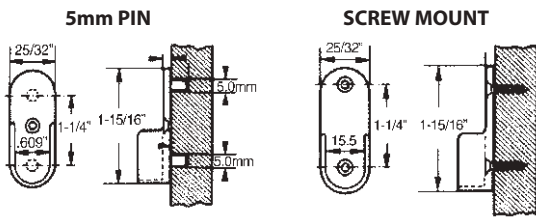

• 25/32" x 1-15/16" Size

Part #	Mounting	Finish
S84-3015P-SB	5mm Pins	Satin Brass
S84-3015P-SC		Satin Chrome
S84-3015P-ORB		Oil Rubbed Bronze
S84-3015P-BK		Black
S84-3015S-SB	Screw Mount	Satin Brass
S84-3015S-SC		Satin Chrome
S84-3015S-ORB		Oil Rubbed Bronze
S84-3015S-BK		Black

Screws sold separately, use #8 x 3/4" Flathead drywall screw, Part# **SCR-8750FHZ**



Oval Rod Center Supports for 15mm x 30mm Oval Rod

- Designed to give extra support for longer spans

Part #	Finish
S84-3015CS-SB	Satin Brass
S84-3015CS-SC	Satin Chrome
S84-3015CS-ORB	Oil Rubbed Bronze
S84-3015CS-BK	Black

Screws sold separately, use #8 x 3/4" Flathead drywall screw, Part# **SCR-8750FHZ**

Aluminum Round 1-5/16" Closet Rod

- Eight foot lengths
- Wall thickness 5/64"

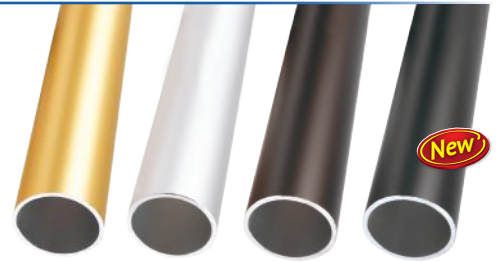
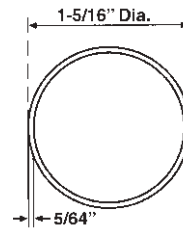

Part #	Finish
S84-1516-SB	Satin Brass
S84-1516-SC	Satin Chrome
S84-1516-ORB	Oil Rubbed Bronze
S84-1516-BK	Black

Round 1-5/16" Closet Rod Flange With Pins



• 5mm • 1-9/16" OD Size

Part #	Description	Finish
S84P-1516U-SB	U-Flange w/Pins	Satin Brass
S84P-1516U-SC		Satin Chrome
S84P-1516U-ORB		Oil Rubbed Bronze
S84P-1516U-BK		Black
S84P-1516O-SB	O-Flange w/Pins	Satin Brass
S84P-1516O-SC		Satin Chrome
S84P-1516O-ORB		Oil Rubbed Bronze
S84P-1516O-BK		Black

Round Closet Rod Supports for 1-5/16" Round Rod



• Screw Mount • 2-3/4" OD Size

Part #	Description	Finish
S84-1516U-SB	U-Flange	Satin Brass
S84-1516U-SC		Satin Chrome
S84-1516U-BK		Black
S84-1516O-SB		Satin Brass
S84-1516O-SC	O-Flange	Satin Chrome
S84-1516O-ORB		Oil Rubbed Bronze
S84-1516O-BK		Black

Screws sold separately, use #8 x 3/4" Flathead drywall screw, Part# **SCR-8750FHZ**



Round Center Rod Supports for 1-5/16" Round Rod

- Designed to give extra support for longer spans

Part #	Finish
S84-1150CS-SB	Satin Brass
S84-1150CS-SC	Satin Chrome
S84-1150CS-ORB	Oil Rubbed Bronze
S84-1150CS-BK	Black

Screws sold separately, use #8 x 3/4" Flathead drywall screw, Part# **SCR-8750FHZ**

"CREATE - A - CLOSET"...AND MORE! CLOSET, PANTRY AND GARAGE SOLUTIONS

Vanguard®



Extendable Closet Rods

1-1/8" Diameter Steel Closet Rod

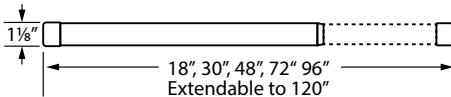

- SPCC Steel
- White powder coat finish
- Available in 5 Sizes. Extendable range up to 120".
- Set desired length and lock into position with a simple twist action.

Part #	Description	Carton Qty.
VG-600-651-WH	Extendable 18"-30"	10 pieces
VG-600-652-WH	Extendable 30"-48"	
VG-600-653-WH	Extendable 48"-72"	
VG-600-654-WH	Extendable 72"-96"	
VG-600-655-WH	Extendable 96"-120"	



Hemlock Closet Rod & End Caps

1-5/16" Diameter Wood Closet Rod w/Plastic Cover



- 96" Long
- Hemlock Wood
- Seamless, scratch resistant and non-marring polyethylene cover
- Finger jointed; thus no bowing, shrinking or expansion of wood
- Optional end caps available

OPTIONAL END CAPS



Part #	Description	Carton Qty.
VG-700-641C-WH	White Closet Rod	18 pieces
VG-140-0295	Chocolate Pearwood Closet Rod	18 pieces
VG-700-627	White End Cap	100 pieces
VG-140-0280	Chocolate Pearwood End Cap	100 pieces

"CREATE - A - CLOSET"...AND MORE! CLOSET, PANTRY AND GARAGE SOLUTIONS



Shelf Center Supports

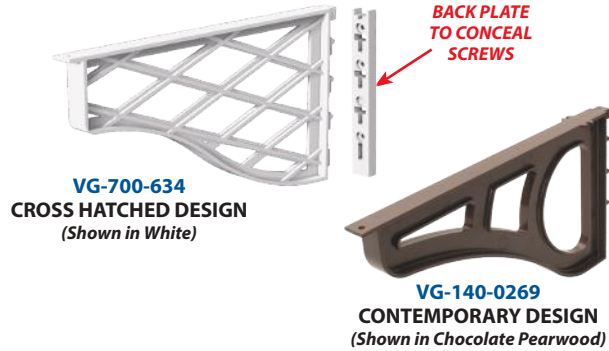

- ABS
- Use with 12", 14" and 16" deep shelves
- Designed to support 150 lbs. when back plate is installed directly into a stud - REQUIRED
- Unique back plate conceals all screws
- Recommended spacing of every 36" to 48", as long as mounted to a stud

Part #	Style	Color	Carton Qty.
VG-700-634	Crosshatch	White	20
VG-140-0275	Crosshatch	Chocolate Pearwood	pieces
VG-140-0153	Contemporary	White	20
VG-140-0269	Contemporary	Chocolate Pearwood	pieces

Shelf & Rod Center Supports

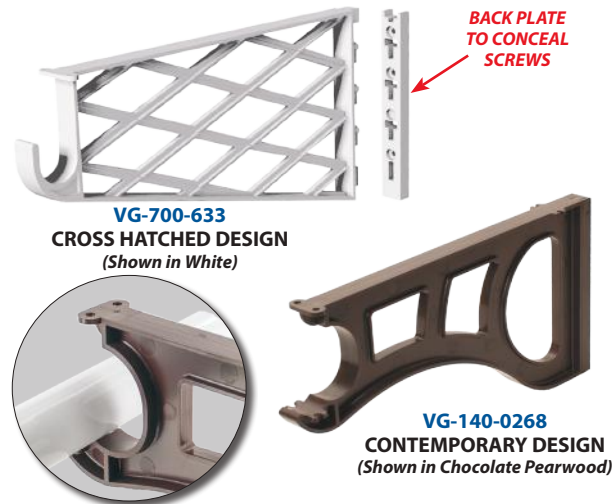

- ABS
- Use with 1-5/16" wood closet rod
- Use with 12", 14" and 16" deep shelves
- Designed to support 150 lbs. when back plate is installed directly into a stud - REQUIRED
- Unique back plate conceals all screws
- Recommended spacing of every 36" to 48", as long as mounted to a stud

Part #	Style	Color	Carton Qty.
VG-700-633	Crosshatch	White	20
VG-140-0274	Crosshatch	Chocolate Pearwood	pieces
VG-140-0152	Contemporary	White	20
VG-140-0268	Contemporary	Chocolate Pearwood	pieces

Rod & Shelf Supports



- ABS
- Use with 1-5/16" wood closet rod
- Works with standard 5/8" or 3/4" shelves x 12", 14" & 16" depths
- Designed to support 300 lbs. when installed with anchor & pin system (VG-700-805B), no stud location required

Part #	Description	Color	Carton Qty.
VG-700-630	12" Deep	White	25
VG-140-0271	12" Deep	Chocolate Pearwood	pairs
VG-140-0111	14" Deep	White	25
VG-140-0265	14" Deep	Chocolate Pearwood	pairs
VG-700-632	16" Deep	White	25
VG-140-0273	16" Deep	Chocolate Pearwood	pairs



ANCHOR & PIN SYSTEM
VG-700-805B (WHITE)
CARTON: 500 sets

"CREATE - A - CLOSET"...AND MORE! CLOSET, PANTRY AND GARAGE SOLUTIONS



Shelf Joiner

- 3/4" and 5/8" shelves
- ABS and Polystyrene
- Field trimmable, nominal 14" & 16" lengths
- Effectively joins two shelf panels for corner and straight applications

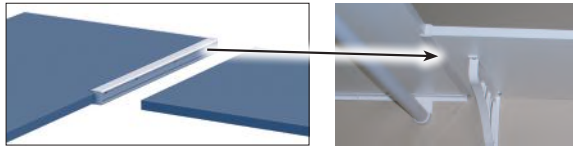
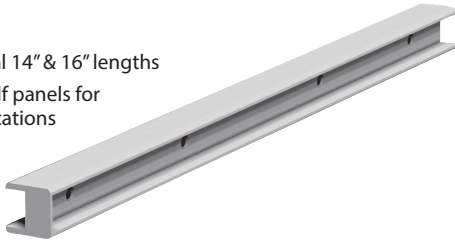

COLORS AVAILABLE:

White

Black

Tan

Cherry Brown

Chocolate Pearwood

Part #	Description	Color	Carton Qty.
VG-700-637-WH	3/4" x 15-3/4" Deep for 16" Shelf	White	100 pieces
VG-140-0277		Chocolate Pearwood	
VG-700-637-BR		Cherry Brown	
VG-700-635-WH	5/8" x 15-3/4" Deep for 16" Shelf	White	100 pieces
VG-140-0276		Chocolate Pearwood	
VG-140-0112		Cherry Brown	
VG-140-0115		Black	
VG-140-0113		Tan	
VG-700-637A-WH	3/4" x 13" Deep for 14" Shelf	White	100 pieces
VG-140-0278		Chocolate Pearwood	
VG-140-0118		Black	

Shelf Support And Finishing Cap

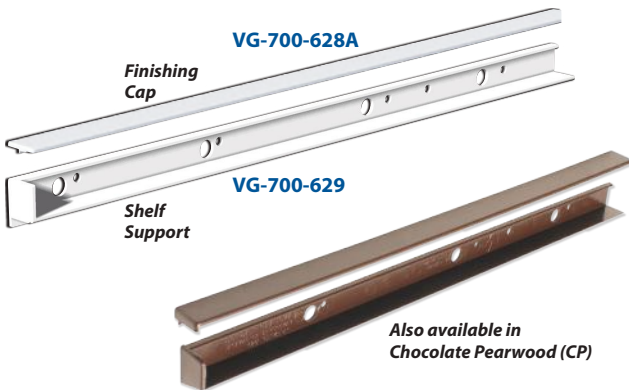

- ABS
- Works with standard 5/8" or 3/4" shelves x 12", 14" & 16" depths
- Designed to support 300 lbs. when installed with anchor & pin system (part#: VG-700-805B), no stud location required
- Optional finishing cap is available to provide a professional finish where the melamine or wood shelf meets the wall

Part #	Description	Size	Color	Carton Qty.
VG-700-629	Shelf Support	12"	White	50 prs.
VG-140-0270	Shelf Support	12"	Chocolate Pearwood	
VG-700-628A	5/8" Finishing Cap	12"	White	40 pcs.
VG-140-0282	5/8" Finishing Cap	12"	Chocolate Pearwood	
VG-700-628C	3/4" Finishing Cap	12"	White	20 prs.
VG-140-0287	3/4" Finishing Cap	12"	Chocolate Pearwood	
VG-140-0110	Shelf Support	14"	White	50 prs.
VG-140-0264	Shelf Support	14"	Chocolate Pearwood	
VG-140-0109	3/4" Finishing Cap	14"	White	20 prs.
VG-700-631	Shelf Support	16"	White	
VG-140-0272	Shelf Support	16"	Chocolate Pearwood	50 prs.
VG-700-628B	5/8" Finishing Cap	16"	White	
VG-140-0284	5/8" Finishing Cap	16"	Chocolate Pearwood	40 pcs.
VG-700-628D	3/4" Finishing Cap	16"	White	



ANCHOR & PIN SYSTEM

VG-700-805B (WHITE)

CARTON: 500 sets

Economy Shelf Support



- ABS
- Designed to provide a shelf support
- Simply install directly into drywall or wood anchors

COLORS AVAILABLE:

White

Black

Part #	Description	Color	Carton Qty.
VG-700-639B-WH	Economy Shelf Support	White	250 pieces
VG-700-639B-BL	Economy Shelf Support	Black	
VG-700-805B	Anchor & Pin System	White	500 sets

Closet Rod Sockets



- ABS
- Available with 5mm pegs, (Inquire for sockets without pegs)
- Supports closet rods up to 1-3/8" diameter
- 32mm compatible

COLORS AVAILABLE:

Almond

Chocolate Pearwood

Part #	Color	Carton Qty.
VG-140-0120	Almond	100
VG-140-0266	Chocolate Pearwood	pieces

STEEL TUBING FOR HANGRAIL, DISPLAY OR CLOSET APPLICATIONS

1" DIAMETER



1" Dia.
x 17 Gauge

BRITE
CHROME
FINISH

Part #	Length
RHR-17/48	48"
RHR-17/60	60"
RHR-17/72	72"
RHR-17/96	96"

For 1" & 1-1/16" Round Tubing

BRITE CHROME FINISH

RHR/OF
"O" FLANGE

RHR/UF
"U" FLANGE

(SCREW HOLE DIA. = 1/4") USE #10 FLATHEAD SCREWS

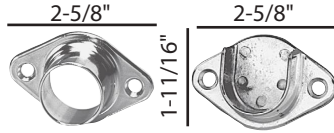

Part #
RHR/OF
RHR/UF

Concealed Round Closet
Rod Flange for 1" Tubing



CHROME PLATED BRASS

Part #

S84-1000CF-BC

Connector for 1" Round Tubing



BRITE ZINC FINISH

Part #

RHR/CONN

1-1/4" DIAMETER

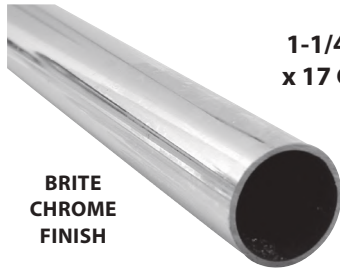

1-1/4" Dia.
x 17 Gauge

BRITE
CHROME
FINISH

Part #	Length
T21-40-14-CHR-6	72"
NEW T21-40-14-CHR-8	96"

For 1-1/4" Round Tubing

BRITE CHROME FINISH

T21/OF
"O" FLANGE

T21/UF
"U" FLANGE

(SCREW HOLE DIA. = .164") USE #6 PANHEAD SCREWS

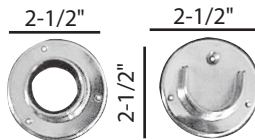

Part #
T21/OF
T21/UF

Concealed Round Closet
Rod Flange for 1-1/4" Tubing



CHROME PLATED BRASS

Part #

S84-1140CF-BC

Outside Cover Sleeve
For 1" & 1-1/4" Diameter Tubing



Cover
Sleeve

BLACK & WHITE
Rigid PVC - 5 ft. lengths

Inquire on custom lengths & colors

Part #	Description
CS100BK	1" I.D. Black
CS100WH	1" I.D. White
CS125WH	1-1/4" I.D. White



ABS End Caps
For 1" & 1-1/4" O.D.

BLACK (BK) or WHITE (WH)

Part #	Tube O.D.	Gauge
C32-U21-*	1"	-
C40-U21-*	1-1/4"	-
DNW-R32-WH	1"	14-23
SHK-40R-BK	1-1/4"	12-18

1" Square Steel Tubing & Accessories



1" Sq.
x 17 Gauge

BRITE CHROME
FINISH

Part #	Size
SQ/60	60"
SQ/72	72"
SQ/96	96"



ABS End Caps For 1"
BLACK (BK) or WHITE (WH)

Part #	Gauge
T32-U2-*	-
DNW-S32-WH	14-23

Rectangular Hangrail / Tubing & Accessories



1-1/2" x 1/2"
x 17 Gauge

BRITE CHROME
FINISH

Part #	Size
RT/48	48"

Connector for
Rectangular Tubing
BRITE ZINC PLATED

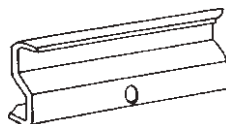

Part #
RT/CONN

Straight Out



12" Long, 1/2" x 1-1/2" tubular arm with
flat end stop to fit 1/2" x 1-1/2" tubing.

Part #
RT/RSO

End Cap

METAL - CHROME



Part #
RT/END

The System with profile

since 1965



Highly Versatile Modular Exhibition Display System

The FOGA® Fastening System offers every conceivable Aluminum Profile, Connector, Hinge and Accessory Component needed to build temporary or permanent Exhibits, Displays and Store Fixtures. All components are compatible with one another and are designed for use with industry standard hardware and accessories.

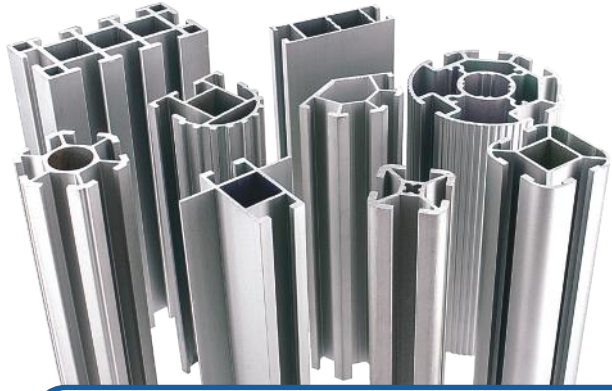

A drawing or simple sketch are all we need to take the first step in bringing your project to life. Design assistance and quotations are available. We can custom bend profiles to your exact specifications. Let us help you get started on your next project.

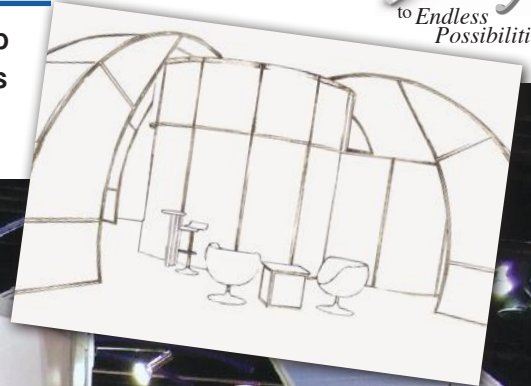

For our FOGA® Design Catalog, go to outwater.com and click on download catalogs
Samples Available

A hex key is all you need to easily assemble a wide range of custom displays



Kiosks

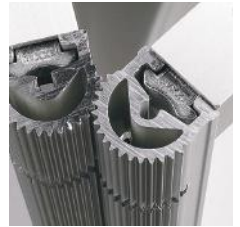

Quick, on-site assembly

Samples Available

The
Key
to Endless
Possibilities

A hex key is all you need to easily assemble a wide range of custom displays

Display Cases

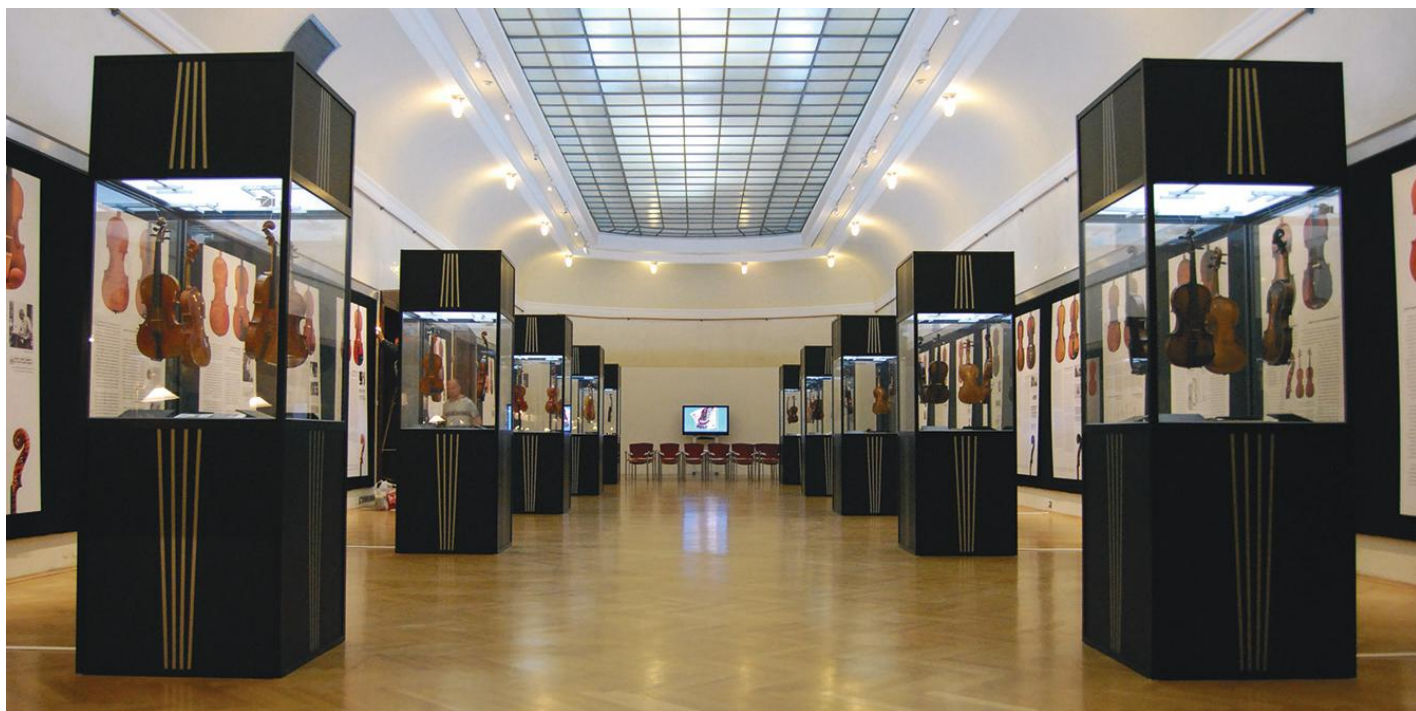

The
Key
to *Endless Possibilities*

A hex key is all you need to easily assemble a wide range of custom displays



Quick, on-site assembly

Samples Available



ALUMINUM FRAMING SYSTEM



Let Our Simple Concept Form Your Great Idea!

Our Aluminum Framing System is Available in 3/4", 1" & 1-1/2" Square Tubing and corresponding Tubing Connectors & Accessories



Great For:

- ★ *Tradeshows*
- ★ *Greenhouses*
- ★ *Menus*
- ★ *Signs*



To enhance our Aluminum Framing System, we offer full services from design to production. We can help with your design, choosing the most cost effective profiles and connectors, figuring the overall sizes for the highest yield from stock lengths, to packing your order for shipment.

Our experienced design staff can work with the simplest drawings to the newest CAD drawings to produce an aesthetically pleasing, totally functional final product. Our Fabrication Department can cut all tubing to size, notch flanges, and drill or punch holes to exacting standards so the fit and finish is unmatched. Finally, we can help with packing your order so it arrives in excellent condition.

Great Ideas Need Accessories!

Shown 1" Tubing with Cladding Fittings & Wide Variety of LED Lighting Options



For more information go to www.outwater.com (see lighting)



ALUMINUM FRAMING SYSTEM

3/4" Square Aluminum Tubing

Lengths: 8 Ft.

Square Tube
Wall Thickness: .050

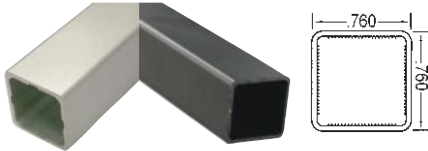

Part #	Finish	Length
AT24-2BK-8	Black	96"
New AT24-2BK-92	Anodized	92-1/2"
AT24-2CL-8	Clear Anodized	96"

3/8" Flange
Wall Thickness: .050

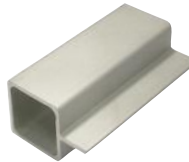

Part #	Finish
AT24-3BK-8	Black Anodized
AT24-3CL-8	Clear Anodized

3/8" 90° Flange
Wall Thickness: .050



Part #	Finish
AT24-4BK-8	Black Anodized
AT24-4CL-8	Clear Anodized

Clear anodized finish is suitable for indoor and outdoor use. Black for indoor only.

3/4" Tubing Connectors & Accessories

Material: Dupont™ Super Toughened Nylon
Available in Black or Grey



2Way Right Angle Connector

Part #	Finish
F24521BK	Black
F24521GY	Grey



3Way Tee Connector

Part #	Finish
F24532BK	Black
F24532GY	Grey

3Way Corner Connector



Part #	Finish
F24533BK	Black
F24533GY	Grey

Straight Base Connector



Part #	Finish
F245323BK	Black
F245323GY	Grey

4Way Connector



Part #	Finish
F24545BK	Black
F24545GY	Grey

Straight Connector



Part #	Finish
F24500BK	Black
F24500GY	Grey

Perpendicular Joiner/Splicer For 3/4" At Tubing W/3/4" Long Self Tapping Screw

ALLOWS TO ATTACH ANY TUBING AT A PERPENDICULAR ANGLE

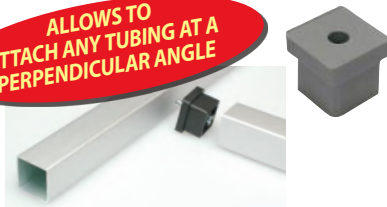

Part #	Finish
F245112MCBK	Black
F245112MCGY	Grey

End Cap

Material: Low-Density Polyethylene



Part #	Color
DNW-S24-BK	Black

Cavity Insert For 3/4" Connector Legs

This accessory fits any 3/4" connector increasing surface area for a tighter fit



Part #	Finish
F24007BK	Black
F24007GY	Grey

4Way Cross Connector



Part #	Finish
F24544BK	Black
F24544GY	Grey



5Way Connector

Part #	Finish
F24558BK	Black
F24558GY	Grey

6Way Connector



Part #	Finish
F24568BK	Black
F24568GY	Grey

ALUMINUM FRAMING SYSTEM

1" Square Aluminum Tubing *Wall Thickness: .044"*

Lengths: 8 Ft.

Double Channel 90°

Fits 1/8" Panel

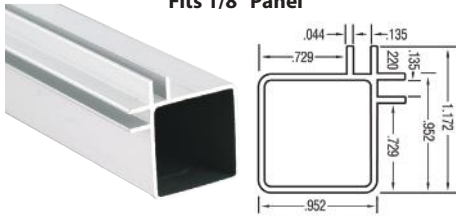

Part #	Finish
AT-14CL-8	Clear Anodized

Single Channel With 1/4" Flange

Fits 1/8" Panel

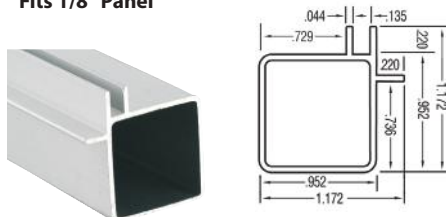

Part #	Finish
AT-15CL-8	Clear Anodized

Single Channel

Fits 1/8" Panel

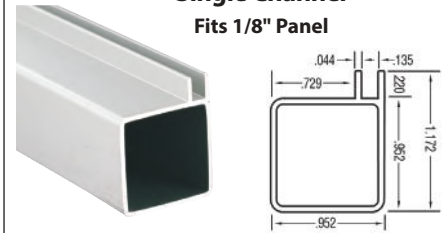

Part #	Finish
AT-17CL-8	Clear Anodized

Single Channel With 1/4" Flange

Fits 1/4" Panel

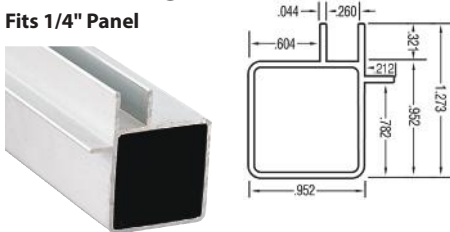

Part #	Finish
AT-16CL-8	Clear Anodized

Single Channel

Fits 1/4" Panel

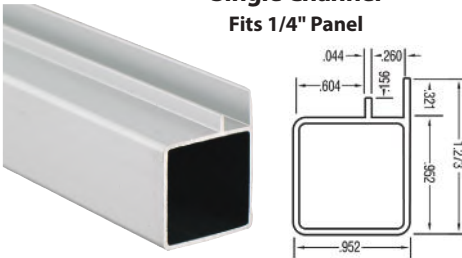

Part #	Finish
AT-18CL-8	Clear Anodized

1/4" Flange

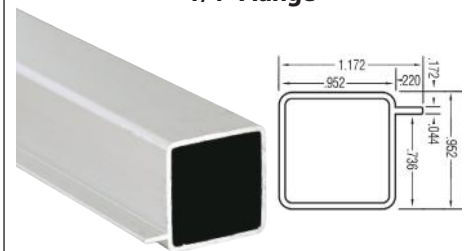

Part #	Finish
AT-19CL-8	Clear Anodized

Sliding Door Track

Peel & Stick Adhesive

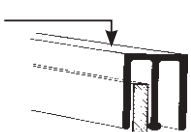

Styrene Track W/Rollers & Peel-N-Stick Adhesive

Colors Available

*BK - Black *SG - Silver Gray

Peel & Stick Adhesive Mount to AT Tubing on [page 17](#)

NOTE:
Rough Opening
Less 7/8" = Door Size

1 Roller
Per Running
Foot Included

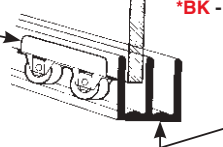

With Adhesive - Available
In 4 & 8 Ft. Lengths

Part #	Length
MT38-A4*	4 ft.
MT38-A8*	8 ft.

Plastic Finger Pulls

With high quality pressure sensitive adhesive backing. No holes to drill. Peel off protective backing paper and apply directly to surface of glass.



Part #	Finish
170-BK	Black
170-CL	Clear

Packed 100 pieces per carton.

ALUMINUM FRAMING SYSTEM

1" Square Aluminum Tubing *Wall Thickness: .065"*

Lengths: 8 Ft.

We Can Cut To Size - Please Inquire

Square Tube

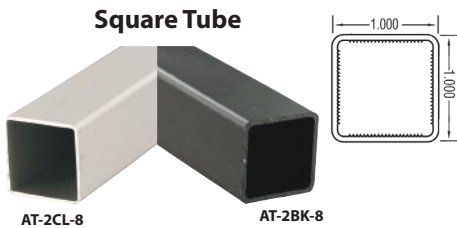

Part # Finish
AT-2CL-8 Clear Anodized
AT-2BK-8 Black Anodized

5/8" Flange



Part # Finish
AT-3CL-8 Clear Anodized
AT-3BK-8 Black Anodized

Single Channel Fits 7/32" Panel

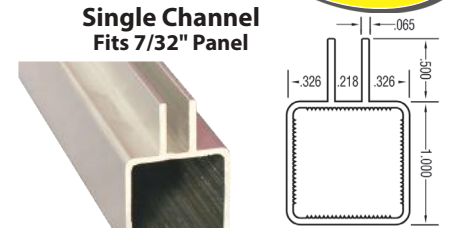

Part # Finish
AT-6CL-8 Clear Anodized
AT-6BK-8 Black Anodized

5/8" 90° Flanges

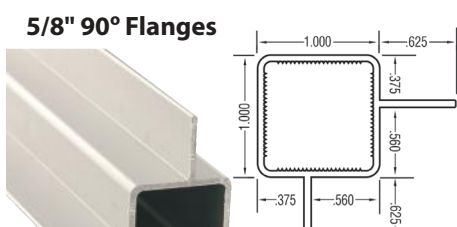

Part # Finish
AT-4CL-8 Clear Anodized
AT-4BK-8 Black Anodized

5/8" 180° Flanges

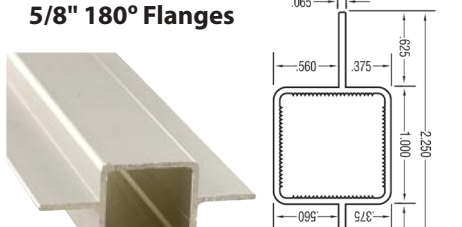

Part # Finish
AT-5CL-8 Clear Anodized
AT-5BK-8 Black Anodized

Double Channel 180° Fits 1/4" Panel

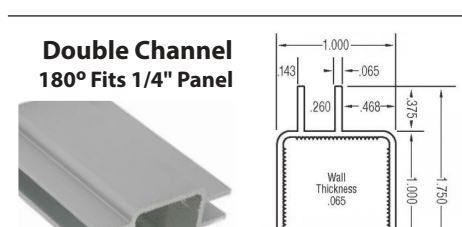

Part # Finish
AT-7CL-8 Clear Anodized
AT-7BK-8 Black Anodized

Triple Channel Fits 1/4" Panel

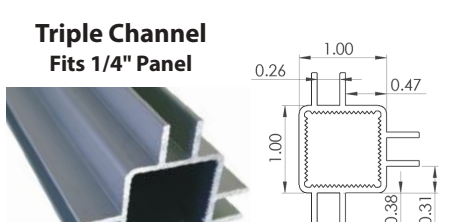

Part # Finish
AT-8CL-8 Clear Anodized
AT-8BK-8 Black Anodized

Slotted 1" Tubing

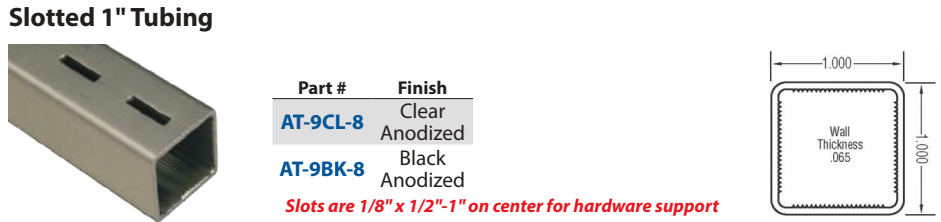

Part # Finish
AT-9CL-8 Clear Anodized
AT-9BK-8 Black Anodized

Slots are 1/8" x 1/2"-1" on center for hardware support

MAY BE USED WITH:

Steel Shelf Brackets



Part #	Description	Finish/Color
Tap-In - .080 Thick Material		
6KB-BC	6" Long Bracket	Bright Chrome
6KB-AL	6" Long Bracket	Almond
6KB-BK	6" Long Bracket	Black
8KB-BC	8" Long Bracket	Bright Chrome
8KB-AL	8" Long Bracket	Almond
10KB-BC	10" Long Bracket	Bright Chrome
12KB-BC	12" Long Bracket	Bright Chrome
12KB-BK	12" Long Bracket	Black
12KB-SC	12" Long Bracket	Satin Chrome
14KB-BC	14" Long Bracket	Bright Chrome
14KB-AL	14" Long Bracket	Almond
14KB-WH	14" Long Bracket	White
16KB-BK	16" Long Bracket	Black
16KB-WH	16" Long Bracket	White
16KB-BC	16" Long Bracket	Bright Chrome

Note: For All Tubing
 Clear anodized finish is suitable for indoor and outdoor use.
 Black for indoor only.

ALUMINUM FRAMING SYSTEM

1" Tubing Connectors & Accessories

Material: Dupont™ Super Toughened Nylon
Available in Black or Grey

2Way Right Angle Connector



Part #	Color
F521BK	Black
F521GY	Grey

3Way Tee Connector



Part #	Color
F532BK	Black
F532GY	Grey

** 3Way Connector w/Heavy Duty Caster Socket



****NOTE:** #F533C will accept a 3/8" diameter x 1" long friction fit caster stem (not included)
See Below for Caster

Part #	Color
F533C/BK	Black
F533C/GY	Grey

3Way Corner Connector



Part #	Color
F533BK	Black
F533GY	Grey

4Way Cross Connector



Part #	Color
F544BK	Black
F544GY	Grey

3Way Connector w/2-3/8" Dia Caster w/Friction Ring Stem



Without Brake	
Part #	Color
F533C/BK-CST	Black
F533C/GY-CST	Grey
With Brake	
Part #	Color
F533C/BK-CSTB	Black
F533C/GY-CSTB	Grey

4Way Connector



Part #	Color
F545BK	Black
F545GY	Grey

5Way Connector



Part #	Color
F558BK	Black
F558GY	Grey

6Way Connector

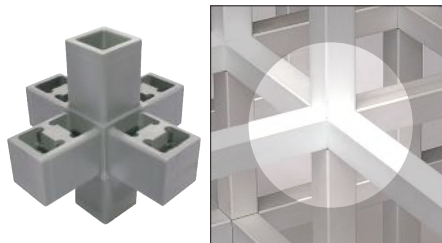

Part #	Color
F568BK	Black
F568GY	Grey

3Way Connector w/Leveler 1/4-20 x 1" Long



1-3/8" Base Dia.
w/Thread Stem & Insert

Part #	Color
F533C/BK-LEV	Black
F533C/GY-LEV	Grey

ALUMINUM FRAMING SYSTEM

1" Tubing Connectors & Accessories

Material: Dupont™ Super Toughened Nylon
Available in Black or Grey

90° Base Connector



Part #	Color
F5323SPBK	Black
F5323SPGY	Grey

Straight Base Connector



Part #	Color
F5323BK	Black
F5323GY	Grey

Perpendicular Joiner/Splicer For 1" AT Tubing with 1 x #8 3/4" Long Self Tapping Screw

ALLOWS TO ATTACH ANY TUBING AT A PERPENDICULAR ANGLE!

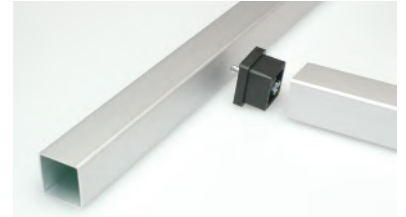

Part #	Color
F5112MCBK	Black
F5112MCGY	Grey

The Invisible Coupling

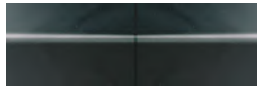
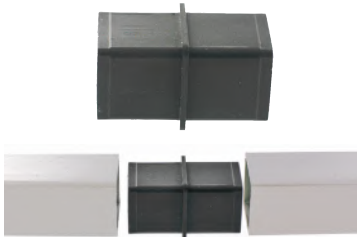

Part #	Color
F5101BK	Black
F5101GY	Grey

Straight Connector



Part #	Color
F500BK	Black
F500GY	Grey

Stack Plug For Use With F533C Connector

GREAT FOR STACKING CASES!



Part #	Color
F4PSPGY	Grey

All Metal Heavy Duty Shelf Rest For Glass Or Wood Shelving

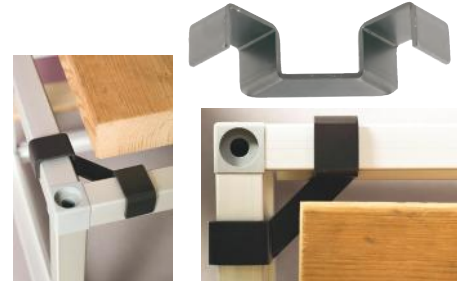

Part #	Finish
F514BK	Black Anodized
F514CL	Clear Anodized

End Cap



Material:
Low-Density
Polyethylene

Part #	Color
SHK-32S-BK	Black

U-Clip

4" Lengths

Aluminum Material - Satin Finish

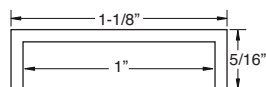
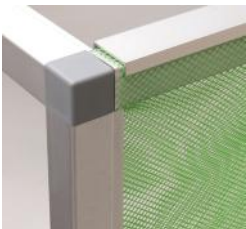

FMJ557-4-S

Cavity Insert For 1" Connector Legs

This accessory fits any 1" connector increasing surface area for a tighter fit



Part #	Color
F007BK	Black
F007GY	Grey

ALUMINUM FRAMING SYSTEM

1" Tubing Connectors & Accessories

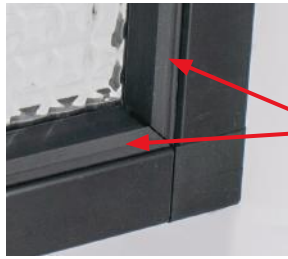

Casing Trim



All cast trim sides can come apart for easy access to insert or remove signage



Cast trim with adhesive tape is shown attached to our 1" tubing

Casing Trim For 1/4" Panels 1" Base

Available in Black or Nickel

With Adhesive Tape

Material: PVC 6' lengths

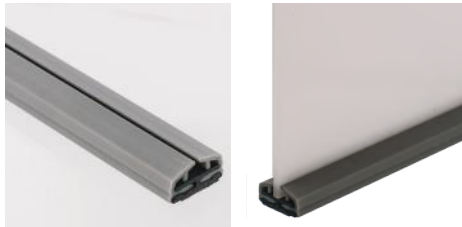

Part #	Finish
CT8NC	Nickel
CT8BK	Black

Casing Trim for 1/2" Panels 1" Base

Available in Black or Nickel

With Adhesive Tape

Material: PVC 6' lengths

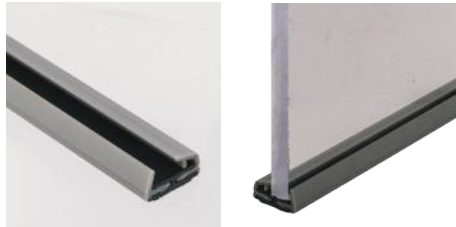

Part #	Finish
CT16NC	Nickel
CT16BK	Black

Casing Trim for 3/4" Panels 1" Base

Available in Black or Nickel

With Adhesive Tape

Material: PVC 6' lengths



Part #	Finish
CT24NC	Nickel
CT24BK	Black

Material: Dupont™ Super Toughened Nylon
Available in Black or Grey



Adjustable 2Way Connector

Material: PVC

15° Incremental locking from 90° to 180° for 1" Tubing

Part #	Finish
FJ22BK	Black
FJ22GY	Grey

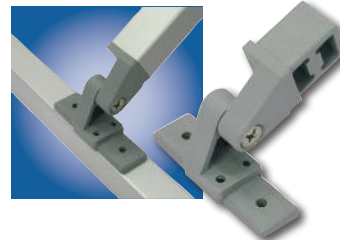

Adjustable Tee Style Connector With Rotating Base

Vertical/Horizontal For 1" Tubing

Material: PVC

Part #	Finish
FJ32BK	Black
FJ32GY	Grey



Adjustable 2Way In-Line Base Connector

For 1" tubing to connect with another tube at multiple angles

Material: PVC

Part #	Finish
FJ31BK	Black
FJ31GY	Grey

Adjustable 2Way Connector W/Locking Nut For 1" Tube



CAPABLE OF 280° RADIUS



Part #	Color
F52AJNBK	Black
F52AJNGY	Grey

ALUMINUM FRAMING SYSTEM

1-1/2" Heavy Duty Aluminum Tubing

Wall Thickness: 1/8" • Lengths: 8 Ft.

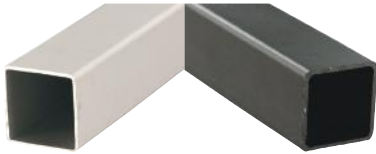

AT48-2CL-8

AT48-2BK-8

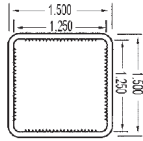

Part # Finish

AT48-2CL-8 Clear Anodized

AT48-2BK-8 Black Anodized

Clear anodized finish is suitable for indoor and outdoor use. Black for indoor only.

1-1/2" Tubing Connectors & Accessories

Material: Dupont™ Super Toughened Nylon
Available in Black or Grey

Connectors fit any 1-1/2" O.D. Aluminum or Steel Tubing with 1/8" wall thickness



**2 Way
Right Angle
Connector**

Part #	Color
F48521BK	Black
F48521GY	Grey

**3 Way
Corner
Connector**



Part #	Color
F48533BK	Black
F48533GY	Grey

**Straight
Connector**



Part #	Color
F48500GY	Grey
F48500BK	Black



**3 Way Tee
Connector**

Part #	Color
F48532BK	Black
F48532GY	Grey

End Cap



Material:
Low-Density Polyethylene

Part #	Color
SHK-48S-BK	Black



**4 Way
Connector**

Part #	Color
F48545BK	Black
F48545GY	Grey

**Perpendicular Joiner/Splicer
with 4 x #10 1-1/4" Long Self Tapping Screws**



Part #	Color
F485112MCBK	Black
F485112MCGY	Grey



PROTOTYPE SAMPLES

We are happy to provide samples for prototypes & design builds - Please Inquire.

COMING SOON!

HEXAGON & OCTAGON CONNECTORS

FOR 1" SQUARE ALUMINUM TUBING

- MADE FROM "SUPER TOUGH" NYLON
- AVAILABLE IN BLACK
- EASY ASSEMBLY

Hexagon Center



Octagon Center

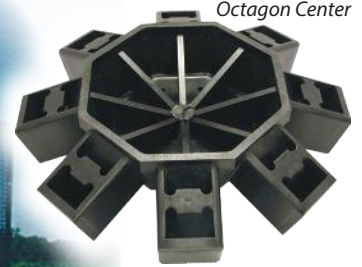

Right Side Top



Left Side Top



T-Cross



Middle

**FOR INDOOR & OUTDOOR APPLICATIONS
IDEAL FOR AVIARIES & ZOO CAGES!**



Side Top



Side
Left Bottom



Side
Bottom Left



Side Bottom



Bottom



Introducing Outwater's Vision Series "See The Glow"



*Our Special Opaque White Lens will
soften & virtually eliminate hot spots*



Aluminum Channel with Opaque White Lens

*Outwater's Vision Series
enables designers to readily create colorful
RGB wallscapes or high luminescence task lights.*

<p>L-VISION-3F</p> <p>Length: 4 Ft. • Lens Material: Styrene Part # L-VISION-3F</p>	<p>L-VISION-3LF</p> <p>Length: 4 Ft. • Lens Material: Frosted Styrene Part # L-VISION-3LF</p>	<ul style="list-style-type: none"> • LED vision system allows for the look of a fixture • Tremendous design opportunities for custom sizes • Options available to work with all of our ribbons
<p>L-VISION-4D</p> <p>Length: 8 Ft. • Lens Material: Acrylic Part # L-VISION-4D</p>	<p>L-VISION-4S</p> <p>Length: 8 Ft. • Lens Material: Acrylic Part # L-VISION-4S</p>	<p>L-VISION-7D</p> <p>Length: 8 Ft. • Lens Material: Styrene Part # L-VISION-7D</p>
<p>L-VISION-8F</p> <p>Length: 8 Ft. • Lens Material: Acrylic Part # L-VISION-8F</p>	<p>L-VISION-10F</p> <p>Length: 8 Ft. • Lens Material: Acrylic Part # L-VISION-10F</p>	<p>L-VISION-12BF</p> <p>Length: 8 Ft. • Lens Material: Acrylic Part # L-VISION-12BF</p> <p>End Caps- Set of 2 Part # L-VISION-12BF-END</p> <p>Mounting Clips- Set of 2 Part # L-VISION-12BF-CLIP</p>



LED Lens

LENS CHARACTERISTICS				
Color	Transmission	Dispersion	Surface Texture	LED Diodes
Frosted	High	Low	Pebbled	Visible
Milk White	Medium	Medium	Smooth	Slightly Visible
Opaque White	Low	High	Smooth	Not Visible

These characteristics are general descriptions.
Customers must decide which color most suits their needs.

Frosted Lens: Allows the most light transmission. This is recommended for task lighting.

Milk White Lens: Allows moderate light transmission. The effect softens the light and reduces glare. A good choice for the largest variety of lighting situations

Opaque White Lens: Allows the least light transmission. The effect softens the light, reduces glare and eliminates the "scalloping" caused by the LED's in most cases

LED Aluminum Channels With Lens: *Create Your Own Light Fixture*

L-TASK-1F

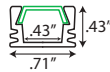

Length: 4 Ft.
Soft White Acrylic Lens

Part #
L-TASK-1F
Accessory Pack
Part #
L-TASK-13-ACC

Includes 2 End Caps, 2 Mounting Clips & Screws

L-TASK-2F

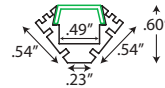

Length: 4 Ft.
Soft White Acrylic Lens

Part #
L-TASK-2F
Accessory Pack
Part #
L-TASK-2-ACC

Includes 2 End Caps, 2 Mounting Clips & Screws

L-TASK-3F

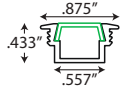

Length: 4 Ft.
Soft White Acrylic Lens

Part #
L-TASK-3F

L-TASK-3LF

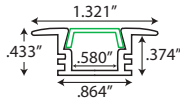

Length: 4 Ft.
Frosted Styrene Lens

Part #
L-TASK-3LF

L-TASK-4

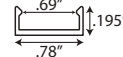
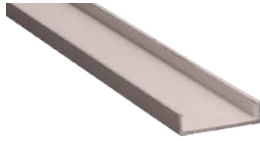

Length: 8 Ft.
No Lens

Part #
L-TASK-4

L-TASK-4D

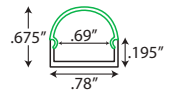
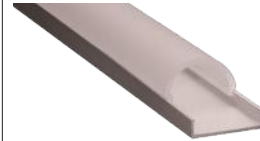

Length: 8 Ft.
Frosted Acrylic Lens

Part #
L-TASK-4D

L-TASK-4S

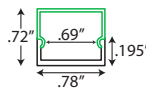
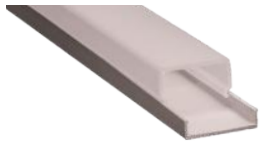

Length: 8 Ft.
Frosted Acrylic Lens

Part #
L-TASK-4S

L-TASK-7D

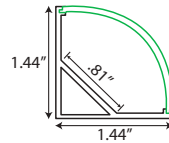
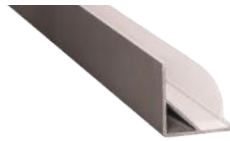

Length: 8 Ft.
Frosted Styrene Lens

Part #
L-TASK-7D

L-TASK-36-6

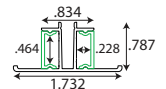

Length: 6.6 Ft.
Milky White Lens
Accessories (2 End Caps & 2 Mounting Clips)

Part #
L-TASK-36-6
End Caps- Set of 2
Part #
L-TASK-36-CAP
Mounting Clips- Set of 2
Part #
L-TASK-36-CLIP



LED LIGHTING

LED Aluminum Channels With Lens: *Create Your Own Light Fixture*



<p>L-TASK-8F</p> <p>Length: 8 Ft. Frosted Acrylic Lens Part # L-TASK-8F</p>	<p>L-TASK-9</p> <p>Length: 12 Ft. No Lens Part # L-TASK-9</p>	<p>L-TASK-10F</p> <p>Length: 8 Ft. Frosted Acrylic Lens Part # L-TASK-10F</p>
<p>L-TASK-11</p> <p>Length: 8 Ft. No Lens Part # L-TASK-11</p>	<p>L-TASK-12</p> <p>Length: 8 Ft. No Lens Part # L-TASK-12</p> <p><i>End Caps- Set of 2</i> Part # L-TASK-12-END</p> <p><i>Mounting Clips- Set of 2</i> Part # L-TASK-12-CLIP</p>	<p>L-TASK-12F</p> <p>Length: 8 Ft. Frosted Styrene Lens Part # L-TASK-12F</p> <p><i>End Caps- Set of 2</i> Part # L-TASK-12-END</p> <p><i>Mounting Clips- Set of 2</i> Part # L-TASK-12-CLIP</p>
<p>L-TASK-13</p> <p>Length: 8 Ft. No Lens Part # L-TASK-13</p>	<p>L-TASK-14F</p> <p>Length: 4 Ft. Frosted Styrene Lens Part # L-TASK-14F</p>	<p>L-TASK-16</p> <p>Length: 12 Ft. No Lens Part # L-TASK-16</p>
<p>L-TASK-17</p> <p>Length: 8 Ft. No Lens Part # L-TASK-17</p>	<p>L-TASK-57</p> <p>Length: 12 Ft. No Lens Part # L-TASK-57</p>	
<p>L-TASK-82</p> <p>Length: 12 Ft. No Lens Part # L-TASK-82</p>	<p>L-TASK-149</p> <p>Finish: Mill With Tape Length: 4 Ft. No Lens Part # L-TASK-149</p>	



L-TASK-18-6

Length: 6.6 Ft. • Milky White Lens Accessories (2 End Caps & 2 Mounting Clips)

Part #

L-TASK-18-6

End Caps- Set of 2

Part #

L-TASK-18-CAP

Mounting Clips- Set of 2

Part #

L-TASK-18-CLIP

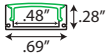

L-TASK-18F-6

Length: 6.6 Ft. • Milky White Lens Accessories (2 End Caps & 2 Mounting Clips)

Part #

L-TASK-18F-6

End Caps- Set of 2

Part #

L-TASK-18F-CAP

Mounting Clips- Set of 2

Part #

L-TASK-18F-CLIP

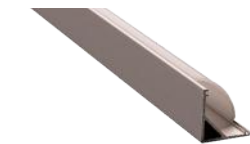
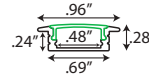

L-TASK-19D-*

Length: 6.6 Ft. • Milky White Lens Accessories (2 End Caps & 2 Mounting Clips)

Part #

L-TASK-19D-6

End Caps- Set of 2

Part #

L-TASK-19D-CAP

Mounting Clips- Set of 2

Part #

L-TASK-19D-CLIP



L-TASK-19S-6

Length: 6.6 Ft. • Milky White Lens Accessories (2 End Caps & 2 Mounting Clips)

Part #

L-TASK-19S-6

End Caps- Set of 2

Part #

L-TASK-19S-CAP

Mounting Clips- Set of 2

Part #

L-TASK-19S-CLIP



L-TASK-20PD-6

Length: 6.6 Ft. • Milky White Lens Accessories (2 End Caps & 2 Mounting Clips)

Part #

L-TASK-20PD-6

End Caps- Set of 2

Part #

L-TASK-20PD-CAP

Mounting Clips- Set of 2

Part #

L-TASK-20PD-CLIP

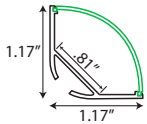

L-TASK-21PD-6

Length: 6.6 Ft. • Milky White Lens Accessories (2 End Caps)

Part #

L-TASK-21PD-6

End Caps- Set of 2

Part #

L-TASK-21PD-CAP

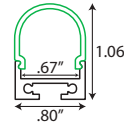

L-TASK-22WP-6

Length: 6.6 Ft. • Milky White Lens Accessories (2 End Caps & 2 Mounting Clips)

Part #

L-TASK-22WP-6

End Caps- Set of 2

Part #

L-TASK-22WP-CAP

Mounting Clips- Set of 2

Part #

L-TASK-22WP-CLIP

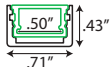

L-TASK-23W-6

Length: 6.6 Ft. • Milky White Lens Accessories (2 End Caps & 2 Mounting Clips)

Part #

L-TASK-23W-6

End Caps- Set of 2

Part #

L-TASK-23W-CAP

Mounting Clips- Set of 2

Part #

L-TASK-23W-CLIP

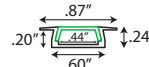

L-TASK-25-6

Length: 6.6 Ft. • Milky White Lens Accessories (2 End Caps & 2 Mounting Clips)

Part #

L-TASK-25-6

End Caps- Set of 2

Part #

L-TASK-25-CAP

Mounting Clips- Set of 2

Part #

L-TASK-25-CLIP

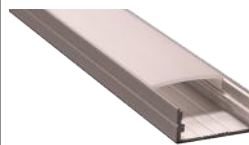
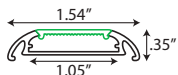

L-TASK-26-6

Length: 6.6 Ft. • Milky White Lens Accessories (2 End Caps & 2 Mounting Clips)

Part #

L-TASK-26-6

End Caps- Set of 2

Part #

L-TASK-26-CAP

Mounting Clips- Set of 2

Part #

L-TASK-26-CLIP

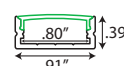

LED LIGHTING

LED Aluminum Channels With Lens: *Create Your Own Light Fixture*



Accessories for L-TASK-37-6

A. Channel & Lens

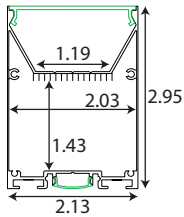

Length: 6.6 Ft.
Milky White Lens

Part #
L-TASK-37-6

B. Hanging Hardware Kit

Kit Includes:
2 Steel Cables (6.6 Ft.)
2 Clips • 2 Screws • 2 Anchors

Part #
L-TASK-37-HANG

C. Power Supply

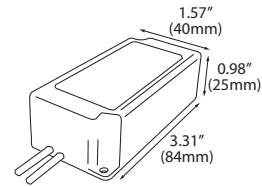

Output Volts: 24V
Max Watts: 96W
Max Amps: 4A
Input Cord: 8 in.
Output Cord: 8 in.
Wire Gauge: 18AWG

Part #
ENO-24V-4A-CDHW

D. End Caps

Set of 2

Part #
L-TASK-37-CAP

E. Mounting Clips

Set of 2

Part #
L-TASK-37-CLIP

Plastic PVC Channels: *Create Your Own Light Fixture*

- Designed for glass or acrylic edge lighting
- Holds our 3/8" LED Ribbon
- Perfect for etched or engraved substrate light guide panels
- No adhesive needed - friction fit

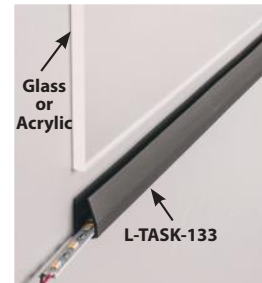

L-TASK-35P-*

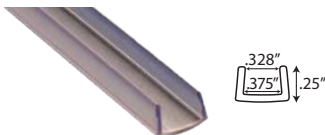

Length: 4 Ft. or 8 Ft.
No Lens

Part #	Finish	Length
L-TASK-35P-*	Clear	4 ft. (*4) or 8 ft. (*8)

L-TASK-50



Shown In Silver

Length: 4 Ft. or 8 Ft.
No Lens

Part #	Finish	Length
L-TASK-50P-*	Clear	4 ft. (*4) or 8 ft. (*8)
L-TASK-50PS-*	Silver	

L-TASK-133



Shown In Silver

Length: 8 Ft.
No Lens

Part #	Finish
L-TASK-133-SIL	Silver
L-TASK-133-BK	Black

ALUMINUM LED CHANNEL DRYWALL PROFILES



- *Material: Silver anodized aluminum*
- *Ideal for illuminating bathrooms, kitchens and similar areas.*
- *Mounts on tiles, ceramic or stoneware surfaces.*
- *Can be mounted between two tiles or used as a corner/wall ending.*
- *Suitable for LED strips with a maximum width of 12.5mm.*
- *Works with our COB24* LED strips, for a more uniform illumination.*
- *2-year guarantee on profiles and covers.*



Perforated L-shaped trim makes it is easy to fit on to concrete, thus achieving a perfect adhesion to wall.



LED LIGHTING

L-Task Aluminum LED Channel Drywall Profile Series: Aluminum Channel with Frosted Lens



Lengths: Nominal 3 Ft. (1 meter) • Material: Satin Anodized Aluminum Finish • Lens: Frosted

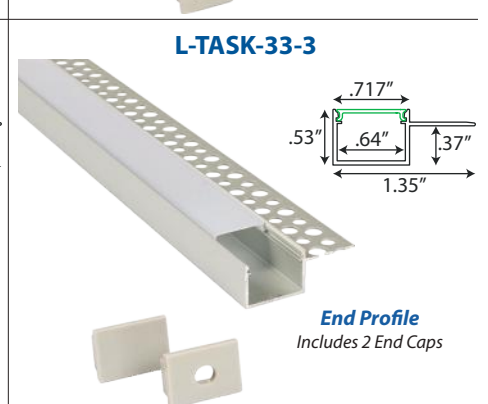
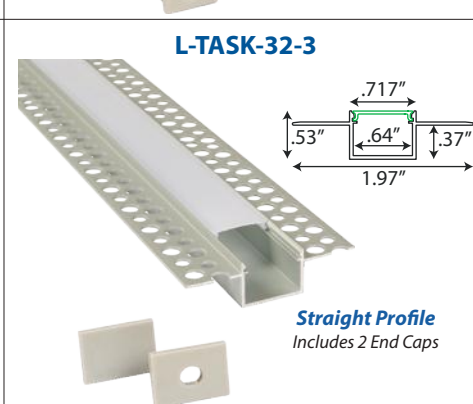
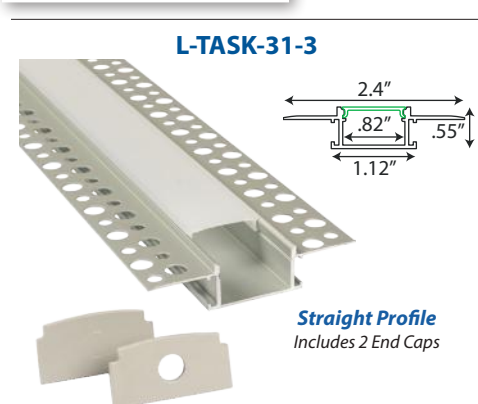
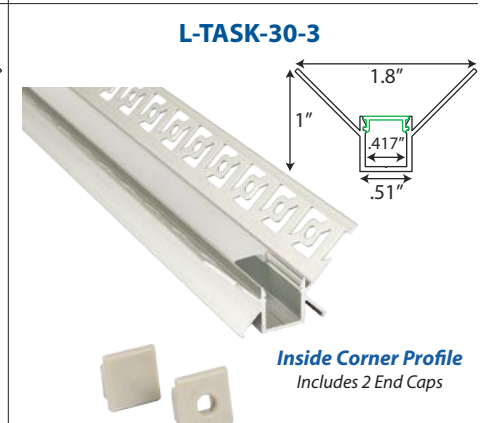

L-Task Lens For Aluminum LED Channel Drywall Profile: Lens Only

Note: Additional end caps available, please inquire

Lengths: Nominal 10 Ft. (3 meters) • Lens: Frosted

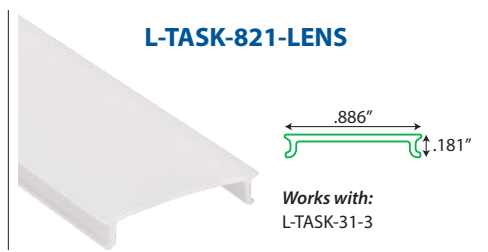
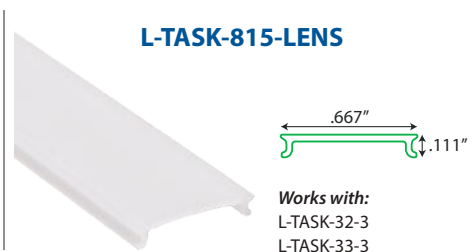
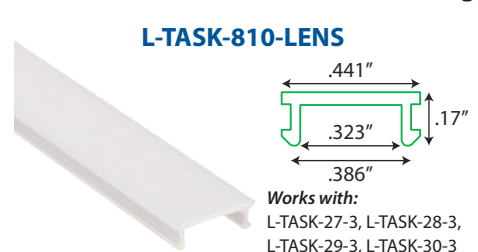

FLEXIBLE ALUMINUM LED CHANNEL PROFILE

New

Bend to almost any curvature an LED installation requires. Can be reshaped again or bent back to the original flat profile if needed.

Easily bend the channel to perfectly fit inside or outside turns with a radius as tight as 6"

- Works with any LED strip 12mm or less.
- Ideal for both straight runs and curved surfaces.
- Great for uneven surfaces, under cabinets and counters, around support beams and curved walls.
- Provides maximum protection against the elements.
- Quickly dissipates minimal heat created by the LEDs and extends the life of the light strips.
- Prevents rust and corrosion.
- Protects LED Light Strips from damage, breakage, moisture and unwanted handling of the lights.
- Suitable for rough indoor or outdoor use.

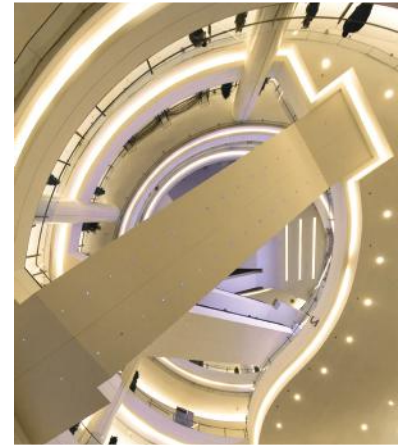

Easy Installation



L-TASK-34-6

Length: Nominal 6.6 Ft. (2 meters)
Material: Satin Anodized Aluminum Finish
Lens: Frosted

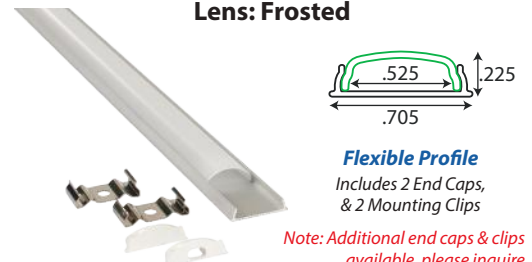

Note: Additional end caps & clips available, please inquire

COMING SOON!

FLEXIBLE LED DRYWALL CHANNELS



FOR DRYWALL-IN, PLASTER-IN, MUD-IN APPLICATIONS

- NOMINAL 3ft.(1m) & 6ft.(2m) LENGTHS
- SATIN ANODIZED ALUMINUM

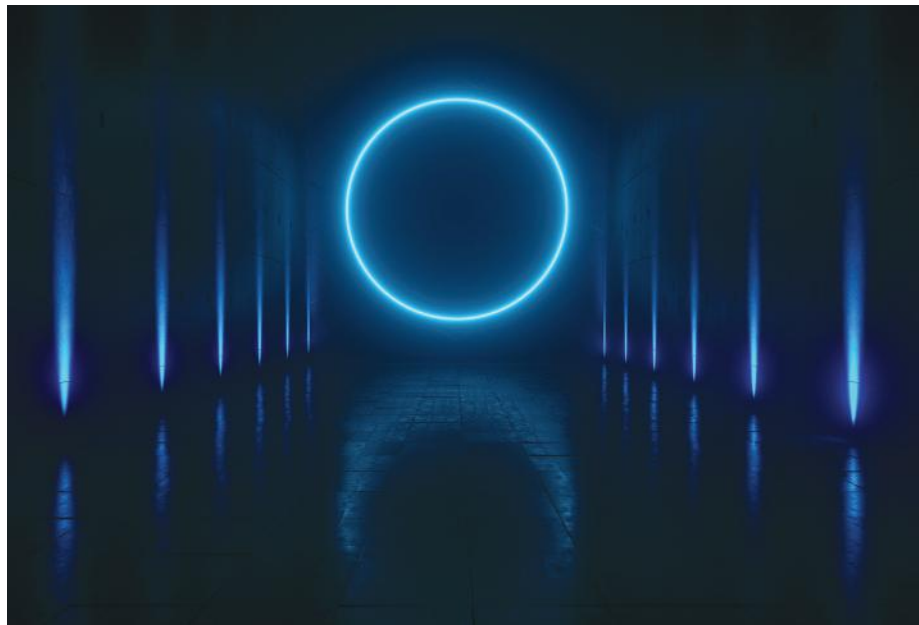

LG24 Long Run Ribbon Flex Series

Available Length: 98.4'

Material: Flexible Silicone Cover with Adhesive

- Commercial Grade
- Field Trimmable
- Consumes Only a Few Watts Per Field Cuttable Strip
- 30,000 Hour Average Bulb Life
- Dimmable
- IP20 & IP65 Options
- No UV Radiation- Safe For Artwork
- Limited 2 Year Warranty

New!

24V

Super Bright Light Output

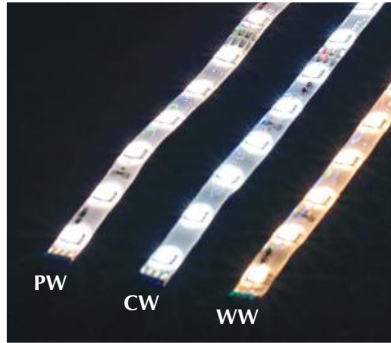

Shown IP65

7" BARE WIRE ENDS CONNECT DIRECTLY TO CONTROLLER



2 Options Available

IP65 Premium Ribbon

Provides Protection From Dust & Splashing Water, Not Submersible

IP20 Premium Ribbon

Provides Low Protection of Dust & Water



Single Ribbon Flex (Up To 76 Lumens Per Foot)



Shown IP65

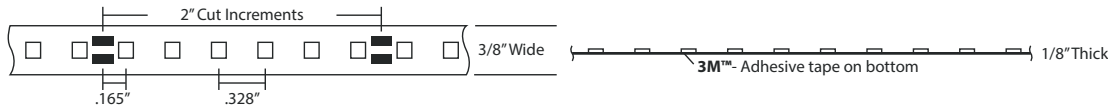

Lighting Specifications

Color Temperature	CW: 6000K-6500K PW: 4000K-4500K WW: 2800K-3000K
Beam Spread	120°
Lumens	76 per ft.
Color Rendering Index	90
Rated Average Life	30,000 hrs.
Constant	Current
Chip Size	2835

Part #	Length	# Of LED Chips	Total Wattage	Max # Can Connect
IP65 (Cool White *CW, Warm White *WW, Pure White *PW)				
LG24-N28120-30M-*	98.4'	3600	120	98.4'
IP20 (Cool White *CW, Warm White *WW, Pure White *PW)				
LG24-I28120-30M-*	98.4'	3600	120	98.4'

Accessories for LG24 Long Run Ribbon Flex Series

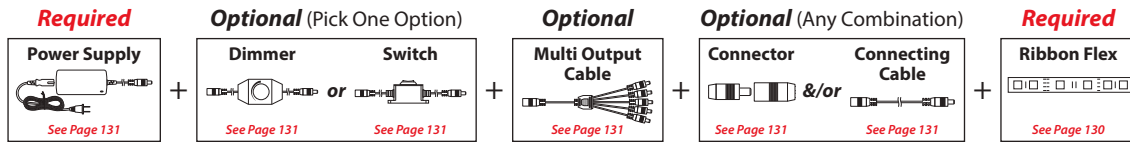

Required

Power Supplies

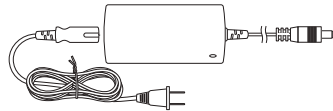

Part #	Type	Amps	Volts	Watts	Dimensions
LED-24V-6A	Desktop	6A	24V	144W	6.77"L x 2.83"W x 1.57"H
LED-24V-8.3A-HW	Hardwire	8.3A	24V	199W	9.84"L x 3.11"W x 2"H

For Product Details & More Power Options, Please Inquire.
Other Options: Plug In | Hardwire | Hardwire Dimmable | Rechargeable Battery

Optional

Dimmers

A power linking cable required.

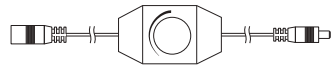

Part #	Description	Finish	Range of Dimming	Size
RF-CTRL-WT	Wall Style	White	10-100%	3.5"L x 1.37"W x 0.75"H
LED-INLINE-DIM	Inline Rotary	Black	0-100%	2-5/8"L x 1-3/8"W x 1"H

For Product Details & More Dimmer Options, Please Inquire.
Other Options: Rotary | Touch Dimmer | Radio Frequency

Connectors

For Use With Bare Wire Connections



Part #	Descriptions	Function	Length
LED-5555-PM	Push Terminal Connector	DC 5.5 male to push terminal connector	1.5"
LED-5555-PF	Push Terminal Connector	DC 5.5 female to push terminal connector	1"
LED-5555-SM	Screw Terminal Connector	DC 5.5 male to screw terminal connector	1.5"
LED-5555-SF	Screw Terminal Connector	DC 5.5 female to screw terminal connector	1.5"

Connecting Cables

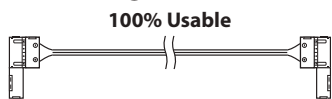

Part #	Works With	Description	Color	Length	# of Pins
Pin Connection (Pins Included)					
RIB10-100U-C1-120	RGB Ribbon	Lights areas without	Black	24"	2
RIB10-100U-C2-120	RGB Ribbon	multiple power supplies	Black	36"	2

End To End For

100% Usable Connections

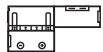

Part #	Works With	Description	# of Pins
RIB10-100U-EE-120	RGB Ribbon	Usable connection directly connects 2 cut pieces	2

Mounting Clips



Part #	Works With	Description	Material	Size
LED-10MM-MC-IP20	RGB Ribbon	For IP20 Ribbon 1 mounting clip & screw	Plastic	3/8"
LED-10MM-MC-IP65	RGB Ribbon	For IP65 Ribbon 1 mounting clip & screw	Plastic	3/8"

For More Mounting Clip Options, Please Inquire.

New!

24V



COB24 Ribbon Flex Series

Available Lengths: 8.25' & 16.4'

Material: Flexible Silicone Cover with Adhesive

- Commercial Grade
- Field Trimmable
- Consumes Only a Few Watts Per Field Cuttable Strip
- 30,000 Hour Average Bulb Life
- Dimmable
- No UV Radiation- Safe For Artwork
- Limited 2 Year Warranty

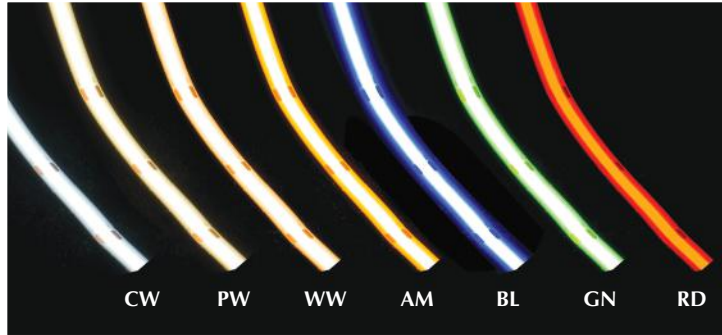

7" BARE WIRE ENDS CONNECT DIRECTLY TO CONTROLLER



IP20 Cut Per LED Ribbon
Provides Low Protection of Dust & Water

COB244-I480-* (Up To 299 Lumens Per Foot)

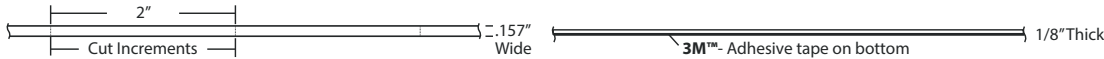

Part #	Length	# Of LED Chips	Total Wattage	Max # Can Connect
4mm IP20 (Cool White *CW, Warm White *WW, Pure White *PW)				
COB244-I480-16*	16.4'	2400	25	16.4'

Lighting Specifications

Color Temperature	CW: 6000K-6500K PW: 4000K-4500K WW: 2800K-3000K
Beam Spread	180°
Lumens	CW: 299 per ft. PW: 283 per ft. WW: 256 per ft.
Color Rendering Index	90
Rated Average Life	30,000 hrs.
Constant	Voltage
Chip Size	COB

COB248-I480-* (Up To 299 Lumens Per Foot)



Part #	Length	# Of LED Chips	Total Wattage	Max # Can Connect
8mm IP20 (Cool White *CW, Warm White *WW, Pure White *PW)				
COB248-I480-8*	8.25'	1200	20	16.4'
COB248-I480-16*	16.4'	2400	40	16.4'

Lighting Specifications

Color Temperature	CW: 6000K-6500K PW: 4000K-4500K WW: 2800K-3000K
Beam Spread	180°
Lumens	CW: 299 per ft. PW: 283 per ft. WW: 256 per ft.
Color Rendering Index	90
Rated Average Life	30,000 hrs.
Constant	Voltage
Chip Size	COB

COB2410-I480-* (Up To 363 Lumens Per Foot)

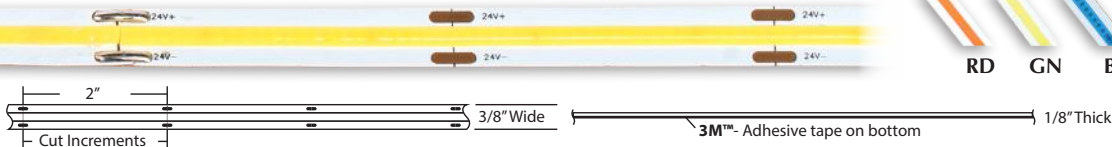

Part #	Color Temp	Length	# Of LED Chips	Total Wattage	Max # Can Connect
10mm IP20 (Cool White *CW, Warm White *WW, Pure White *PW)					
COB2410-I480-8*	*CW, *PW, *WW	8.25'	1200	30	16.4'
COB2410-I480-16*	*CW, *PW, *WW	16.4'	2400	60	16.4'
COB2410-I480-16AM	Amber	16.4'	2400	60	16.4'
COB2410-I480-16BL	Blue	16.4'	2400	60	16.4'
COB2410-I480-16GN	Green	16.4'	2400	60	16.4'
COB2410-I480-16RD	Red	16.4'	2400	60	16.4'

Lighting Specifications

Color Temperature	CW: 6000K-6500K PW: 4000K-4500K WW: 2800K-3000K AM: 1800K-2000K
Beam Spread	180°
Lumens	CW: 363 per ft. PW: 343 per ft. WW: 311 per ft.
Color Rendering Index	90
Rated Average Life	30,000 hrs.
Constant	Voltage
Chip Size	COB

Accessories for COB24 Ribbon Flex Series

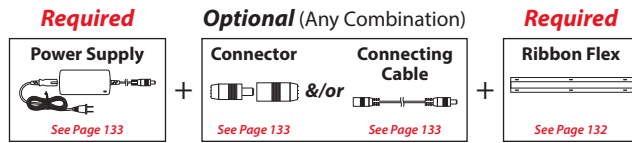

Required

Power Supplies

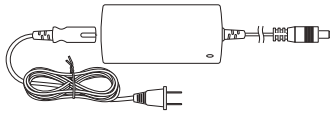

Part #	Type	Amps	Volts	Watts	Dimensions
LED-24V-3A	Desktop	3A	24V	72W	4.68"L x 2.34"W x 1.48"H
LED-24V-4A	Desktop	4A	24V	96W	6.77"L x 2.83"W x 1.57"H

For Product Details & More Power Options, Please Inquire.
Other Options: Plug In | Hardwire | Hardwire Dimmable | Rechargeable Battery

Optional

Connectors

For Use With Bare Wire Connections



Part #	Descriptions	Function	Length
LED-5555-PM	Push Terminal Connector	DC 5.5 male to push terminal connector	1.5"
LED-5555-PF	Push Terminal Connector	DC 5.5 female to push terminal connector	1"
LED-5555-SM	Screw Terminal Connector	DC 5.5 male to screw terminal connector	1.5"
LED-5555-SF	Screw Terminal Connector	DC 5.5 female to screw terminal connector	1.5"

Connecting Cables

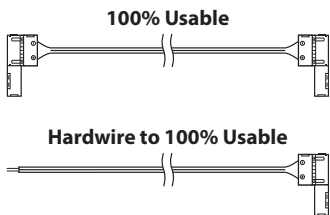

Part #	Works With	Description	Color	Width	Length	# of Pins
Pin Connection (Pins Included)						
COB8-100U-C1	RGB Ribbon	Lights areas without multiple power supplies	Black	8mm	6"	2
COB10-100U-C1	RGB Ribbon		Black	10mm	6"	2
For 2 Cut Pieces of Ribbon						
COB8-100U-ST	RGB Ribbon	100% Hardwire	Multi	8mm	6"	2
COB10-100U-ST	RGB Ribbon		Multi	10mm	6"	2

For More Extension Cable Options, Please Inquire.

End To End For 100% Usable Connections

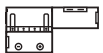

Part #	Works With	Width	Description	# of Pins
COB8-100U-EE	RGB Ribbon	8mm	Usable connection directly	2
COB10-100U-EE	RGB Ribbon	10mm	connects 2 cut pieces	2

Mounting Clips

For IP65



Part #	Works With	Description	Material	Size
LED-8MM-MC-IP65	RGB Ribbon	For IP65 Ribbon	Plastic	5/16"
LED-10MM-MC-IP65	RGB Ribbon	1 mounting clip & screw	Plastic	3/8"

For More Mounting Clip Options, Please Inquire.

Universal LED Ribbon Mounting Channels

Aluminum channels that work with our ribbons

To See A Full Line Of Our Mounting Channels, See Pages 121-129



COB24 CCT Ribbon Flex Series



24V



Versatile & field trimmable LED ribbon can be adapted to meet many design needs. Can program color temperature ranges between 2800K-6000K.

Nominal Lengths: 16.4'

Material: Flexible White PCB with Adhesive

- This NEW color changing temperature (CCT) provides greater energy efficiency and high lumens.
- 3M Adhesive Back
- Limited 3 Year Warranty

IP20 Cut Per LED Ribbon
Provides Low Protection of Dust & Water

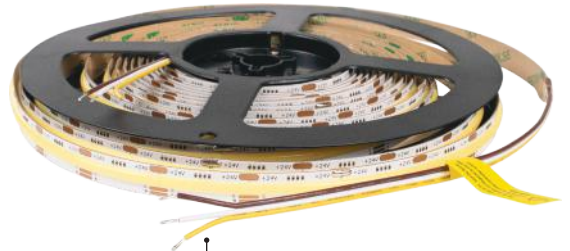

7" BARE WIRE ENDS CONNECT DIRECTLY TO CONTROLLER

COB2410-I640-16CCT (Up To 363 Lumens Per Foot)

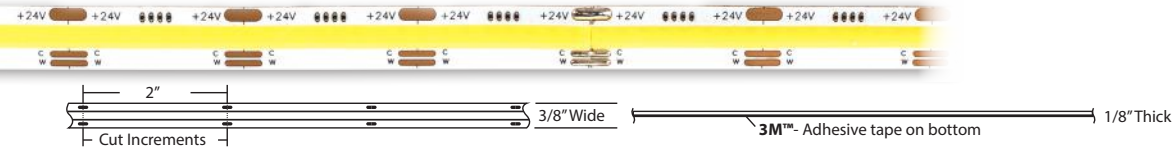

Part #	Length	# Of LED Chips	Total Wattage	Max # Can Connect
COB2410-I640-16CCT	16.4'	2400	80	16.4'

Lighting Specifications

Color Temperature	2800K-6500K
Beam Spread	180°
Lumens	363 per ft.
Color Rendering Index	90
Rated Average Life	30,000 hrs.
Constant	Voltage
Chip Size	COB

Accessories for COB24 CCT Ribbon Flex Series

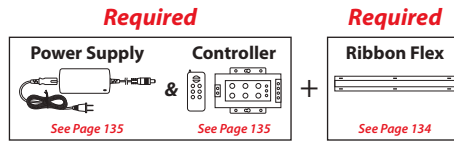

Required

Power Supplies

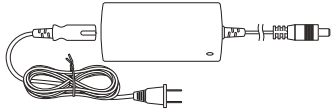

Part #	Type	Amps	Volts	Watts	Dimensions
LED-24V-3A	Desktop	3A	24V	72W	4.68"L x 2.34"W x 1.48"H
LED-24V-6A	Desktop	6A	24V	144W	6.77"L x 2.83"W x 1.57"H

For Product Details & More Power Options, Please Inquire.

Other Options: Plug In | Hardwire | Hardwire Dimmable | Rechargeable Battery

Option 1: RF Controller With Remote For CCT



LED-ADJTEM-CR2

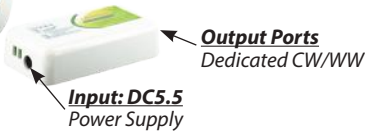

Features:

- 3A / 24V / 72W
- Input Wire: Female DC 5.5 / Hardwire
- Output Wire: Hardwire
- Controller Size: 4-1/2"L x 2-3/16"W x 3/4"H
- Receiver Size: 3-5/8"L x 1-3/4"W x 7/8"H
- Color: White

Controller Functions:

- Mounting: Surface
- Remote Control Function: RF
- Gradient Change: 11 Grades
- Brightness Adjusting: 20 Grades
- Sound: No

Option 2: RF CCT Controller With Desktop or Wall Option



Receiver

Included With Every Dimmer
7" L x 1.75" W x .75" H
Female DC 5.5 Input Cord: 18"

- Each dimmer is paired to the included receiver. However, multiple dimmers can be paired to one receiver. (Instructions included in package)
- Range of Dimming: 10%-100%
- Push Button On/Off Function
- All dimmers work up to 50' away from receiver
- All dimmer controllers run on battery
- Limited 3 Year Warranty
- Radio frequency goes through walls

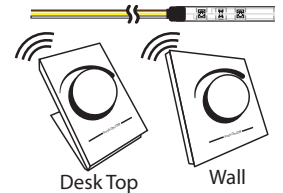
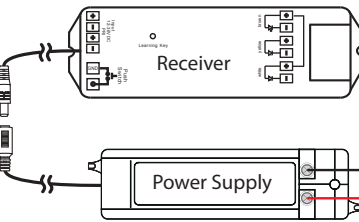

Wall Dimmer

Fits Over A Standard Receptacle Box
3.5" L x 1.37" W x .75" H
RF-CCT-CTRL-WT



Desk Top Dimmer

4" L x 1.5" W x 1.8" H
RF-CCT-CTRL-DT

For More On Radio Frequency Dimmers, Please Inquire.

Universal LED Ribbon Mounting Channels

Aluminum channels that work with our ribbons

To See A Full Line Of Our Mounting Channels, See Pages 121-129

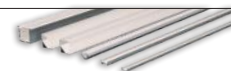

ORAC

Unexpected possibilities



Whether it's a touch of the contemporary or a nod to the classics, each of our products is a chameleon, adept at taking on the character you desire. Here are some glimpses into the myriad of ways our products can animate, define and transform interiors. Every setting, every angle reveals new potential. A new story to be told.

Advantages



READY TO PAINT

All of our products are ready to paint. Colored end finishes on demand.



DURABLE

Orac products are designed to last a lifetime. Smart design and high-end technology assure strong and water resistant products.

Materials



PUROTOUCH®

A high-quality, medium-density polyurethane that allows fine details.

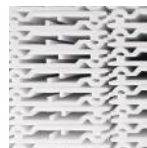

DUROPOLYMER®

An extruded and impact-resistant polymer based on a high-density polystyrene.



DUROFOAM®

An extruded lightweight polymer based on a low-density polystyrene blend.



FLEX

A quality high-density flexible polyurethane.

ORAC 3D Wall Coverings

We invite you to experience the extraordinary with our 3D wall coverings. Captivating sculptural landscapes, these masterpieces redefine your walls, inviting touch and exploration. Discover a range of bold and subtle designs, each a testament to the art of interior transformation.

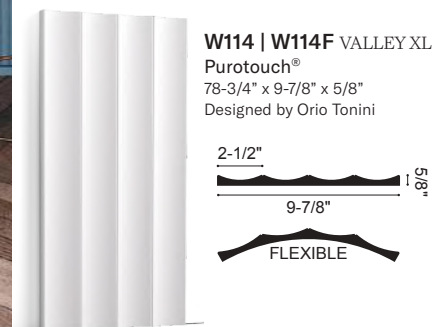
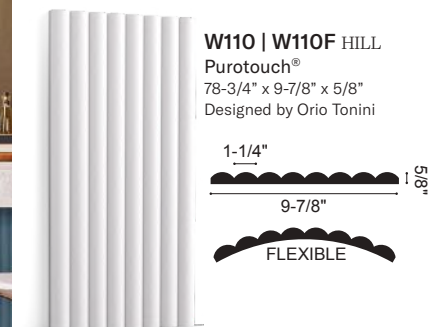
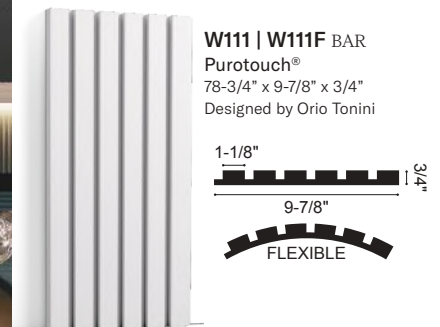
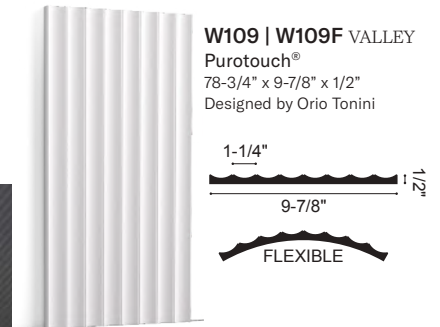
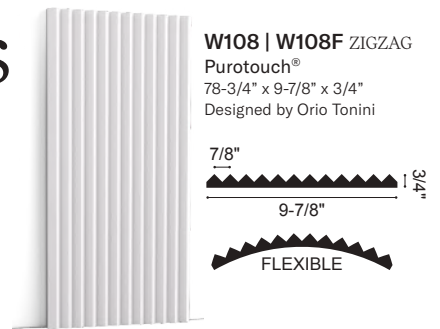

Crafting seamless transitions from floor to wall, from the elegantly ornate to the gracefully understated. We pay meticulous attention to every detail in every design so you can find options that match your vision.

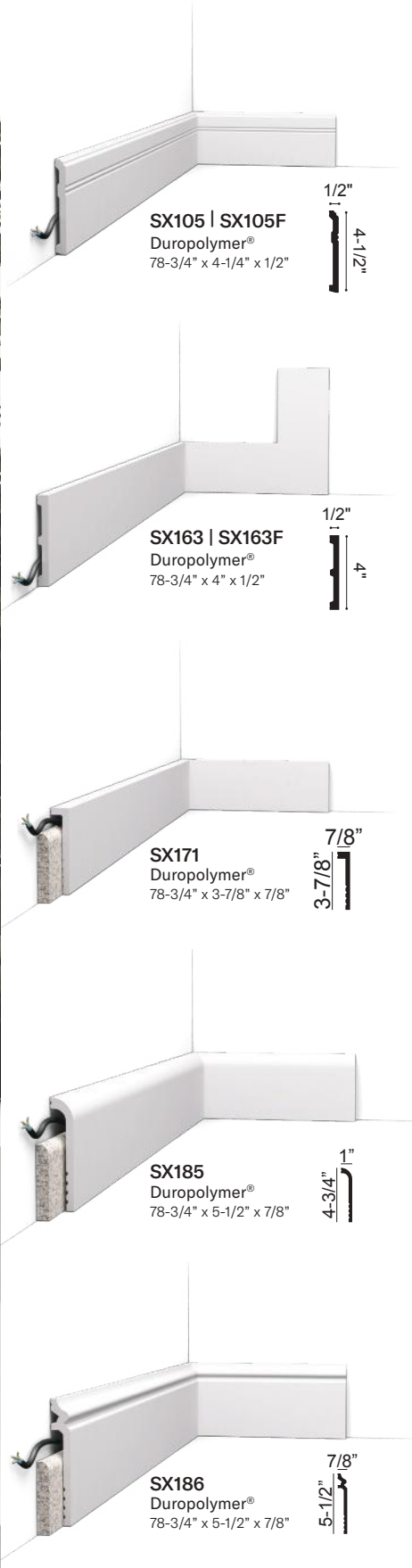

ORAC Panel Mouldings

An empty wall is like a bare base, in need of shape and dimension. Which is why we love to entertain ideas with these versatile accents. By using our panel mouldings, harmony comes into play, a sense of proportion that is balanced and pleasing to the eye.



P8030 | P8030F
Purotouch®
78-3/4" x 1-5/8" x 5/8"



P8020 | P8020F
Purotouch®
78-3/4" x 2-3/8" x 1"



PX103 | PX103F
Duropolymer®
78-3/4" x 1" x 1/2"



PX120 | PX120F
Duropolymer®
78-3/4" x 1-5/8" x 3/4"



PX175 | PX175F
Duropolymer®
78-3/4" x 2" x 5/8"



Our indirect lighting solutions are the unseen maestros of ambiance. They are as versatile as they are subtle, designed to enhance every line and curve. So, we encourage you to integrate them as you see fit, for you to create an atmosphere that complements the time of day and the essence of the moment.

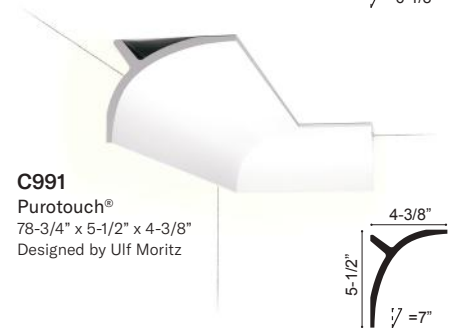
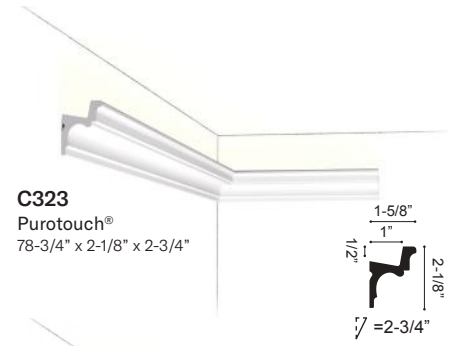

ORAC Cornice Mouldings

It truly does move us when we look up and see how it softens the strict transition between wall and ceiling. For us, a cornice is about attention to detail, be it from ornate to subtle. We have thought them all through so that there should always be an option that meets your personal aspirations.



CX109 | CX109F
Duropolymer®
78-3/4" x 1-3/4" x 1-3/4"

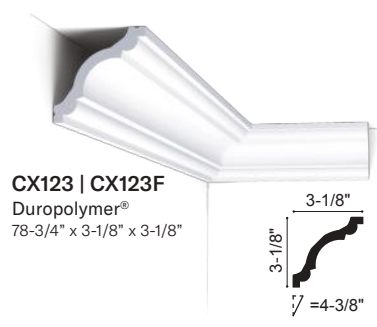

CX123 | CX123F
Duropolymer®
78-3/4" x 3-1/8" x 3-1/8"

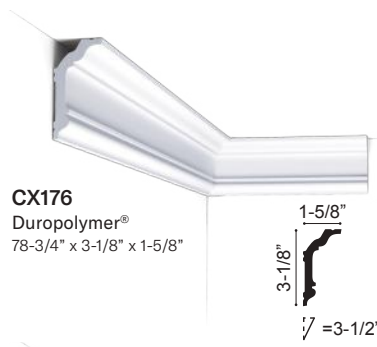

CX176
Duropolymer®
78-3/4" x 3-1/8" x 1-5/8"



C339 | C339F
Purotouch®
78-3/4" x 5-1/2" x 2-1/2"

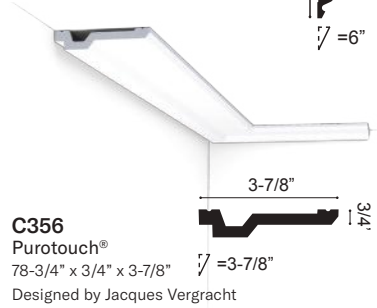

C356
Purotouch®
78-3/4" x 3/4" x 3-7/8"
Designed by Jacques Vergrecht

Deco elements are the subtle whispers of personality that breathe life into a space. From grandiose flourishes to understated accents, we propose options to punctuate your interior design narrative with finesse, for you to find what feels right.



R-10
Puretouch®
ø 5-7/8" x 1-5/8" - ø 3/4"



R-31
Puretouch®
ø 15-1/8" x 1-1/8" - ø 1-3/8"



R-17
Puretouch®
ø 18-1/2" x 1-3/8" - ø 2-1/2"



SOUND DAMPENING • SUSTAINABLE • EASY INSTALLATION

ACOUSTI-PANEL

SLATTED WOOD WALL PANELS

- 94.5" Long
- 12.87" Wide
- 0.82" Thick

OFFERED IN THREE EYE-CATCHING FINISHES

3/8" Black Acoustic Felt Backing



WALNUT



OAK



BLACK DIAMOND

FlexLam

THERMOPLASTIC WALL PANELS

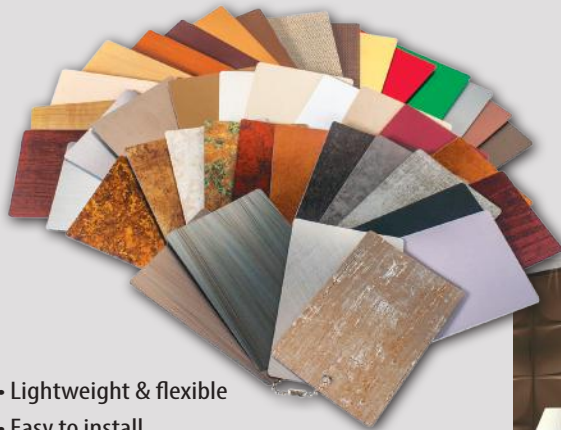

- Lightweight & flexible
- Easy to install
- Impact, abrasion, & chemical resistant properties
- Hundreds of design combinations
- Ceiling Tiles and Custom options also available
- Class A Fire Rated
- Economical packaged shipping to any job site
- Made in USA



3D WALL PANELS



3D WALL PANELS
LINEAR COLLECTION



MAX WALL PANELS



DOOR SKINS



WAINSCOTING

TRANSFORM YOUR WALL INTO
A BEAUTIFUL ACCENT PIECE.

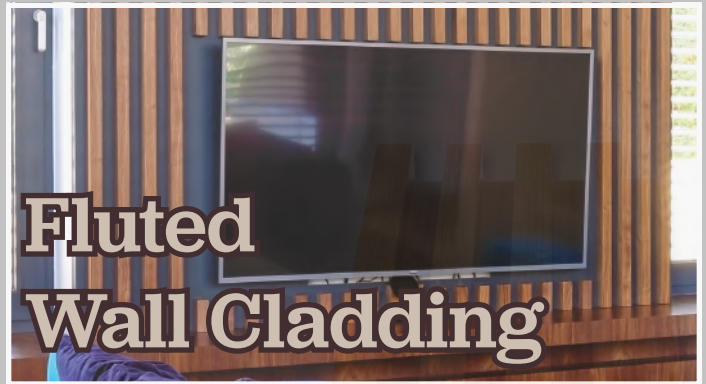
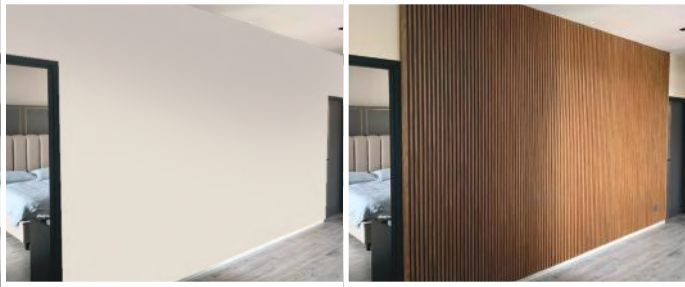

Fluted Wall Cladding

INNOVATIVE • STYLISH • CURRENT

AVAILABLE IN 3 STYLES

SIGNATURE SERIES

PREMIERE SERIES

GRANDE SERIES

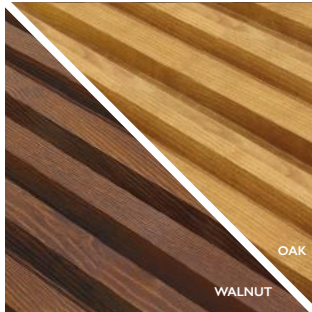

- 9 ft. of usable length (9' 2" actual)
- Eco-friendly wood/plastic composite material
- Laminated surface finish
- Quick and easy-to-install
- Use vertically and horizontally
- Waterproof



NATURAL
ELEMENTS

Flexible Tambour Wall Panels

Nominal 1' x 8' and 4' x 8' Sheets

SOLID WOOD

Available in Cherry, Red Oak,
White Oak, Maple,
Pine (Paintable)



VENEER

Available in Red Oak,
White Oak, Maple



3D WOOD WALLSCAPES

Oak

Natural (Mahogany)

Acacia

Black Walnut

NATURAL SOLID HARDWOOD INTERLOCKING WALL PLANKS

- 4 Species: Oak, Acacia, Walnut and Mahogany
- High quality smooth stained finish
- Dimensional raised, textured design

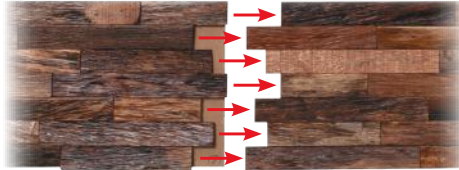

- Create a serene inviting space
- Modern style and Classic charm
- Use in Residential or Commercial settings
- Easy installation

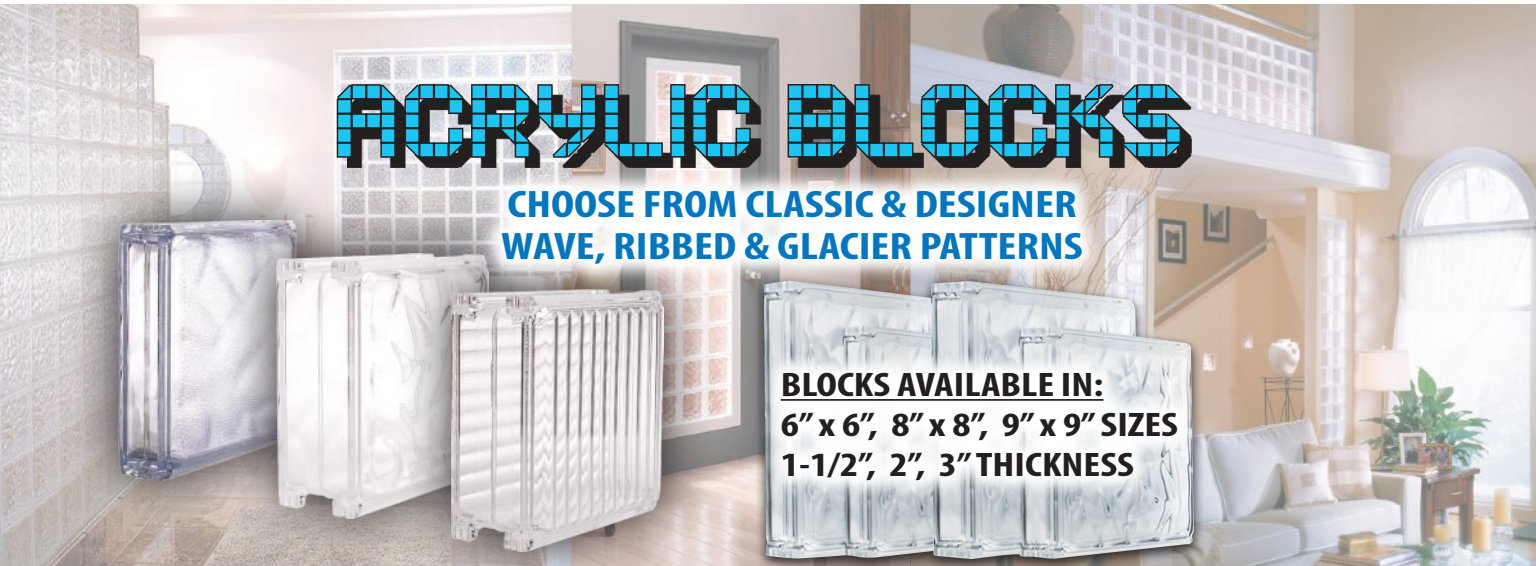

ACRYLIC BLOCKS

CHOOSE FROM CLASSIC & DESIGNER
WAVE, RIBBED & GLACIER PATTERNS

BLOCKS AVAILABLE IN:

6" x 6", 8" x 8", 9" x 9" SIZES

1-1/2", 2", 3" THICKNESS



DECORATIVE

Acrylic Panels



- 4' x 8' High Impact Acrylic Panels
- 3 Thickness Sizes: 1/4", 3/8", 1/2"
- Easy-to-install
- Abrasion & chemical resistant properties

Faux STONE Panels

- 2' x 4' High Density Polyurethane Panels • 3/4" Thick
- Available in Standard & Interlocking Panels
- Suitable for Interior & Exterior Applications



STANDARD
to create your own design

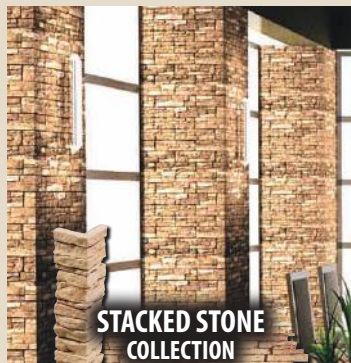

**STACKED STONE
COLLECTION**



**BRICK
COLLECTION**



**STONEWALL
COLLECTION**



INTERLOCKING
for a totally seamless look



METALLIC SELF ADHESIVE MYLAR SHEETS

**4 FT. WIDE ROLLS
UP TO 100 FT. LONG!**

- 0.30" THICK
- PSA BACKING
- STYRENE SUBSTRATE
- SCRATCH & CHEMICAL RESISTANT

**PEEL & STICK
ADHESIVE**

MetLam HIGH PRESSURE METAL LAMINATE

- 4' x 8' SHEETS
- 3/32" THICK
- UV STABLE
- BENDS TO FIT CURVED SURFACES
- CAN BE APPLIED DIRECTLY TO DRYWALL
- SCRATCH & CHEMICAL RESISTANT



Artful Metals



Divine Elements



Aluminum



Copper



Unique Art



Flexible Mirrored Glass Mosaic Sheets

23-1/2" x 23-1/2" Sheets

3/32" Thick

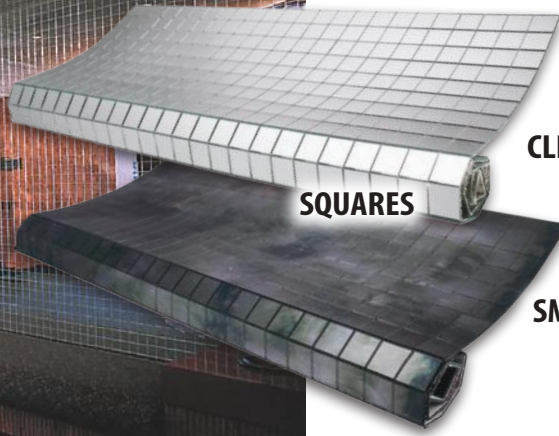

SQUARES

CLEAR MIRROR

SMOKE MIRROR

RECTANGLES

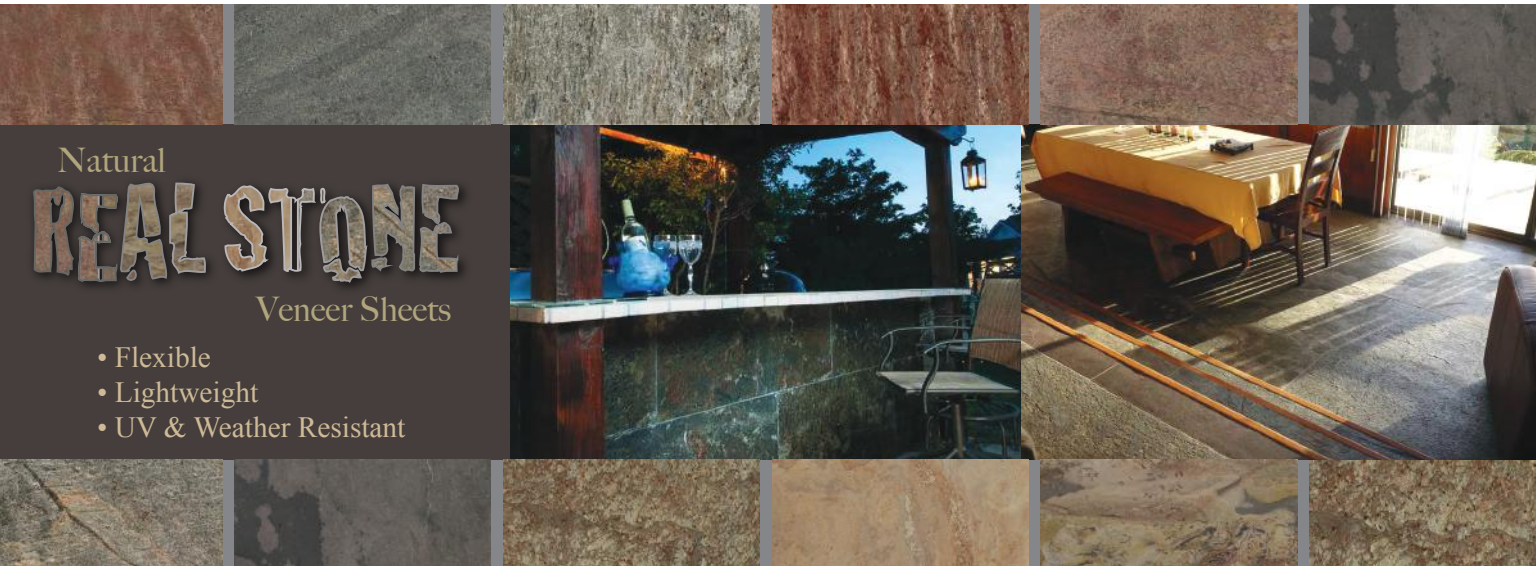
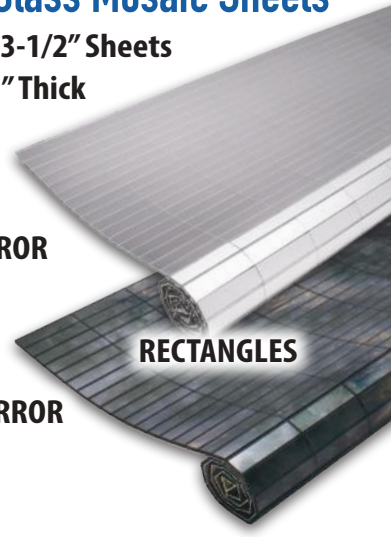

Natural REAL STONE

Veneer Sheets

- Flexible
- Lightweight
- UV & Weather Resistant



WOOD WALLSCAPES

DESIGN YOUR OWN WALL
MIX & MATCH COLORS

Pine Planks
With Peel & Stick Adhesive

46-1/2" Length • 5-1/8" Wide • 3/16" Thick



Outwater Industries, Inc.

24 River Road
P.O. Box 500
Bogota, NJ 07603-0500

PRSRTD STD
U.S. POSTAGE
PAID
DENVER, CO
PERMIT No. 5377

Catalog Code

2401

We encourage you to explore our new website, which makes shopping at Outwater easier than ever before. Online you can access videos, product details and installation guides, download specialty catalogs, and create an account.



www.outwater.com

When you become a registered user take advantage of these benefits:

- Track orders
- View purchase history
- Manage payment methods
- Save items and create wish lists
- Get quotes
- Set up multiple users under one company account



Join our mailing list to receive exclusive offers, free passes to trade shows, and information about exciting new products!

Outwater stocks all products in our east and west coast warehouse facilities to provide customers with fast, cost-effective shipping. Please call our sales department to request free samples.

1-800-631-8375



New Jersey | 24 River Road | Bogota, NJ 07603

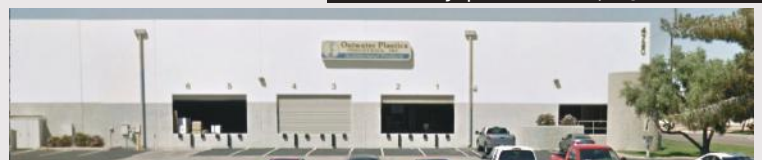

Arizona | 4720 West Van Buren Street | Phoenix, AZ 85043

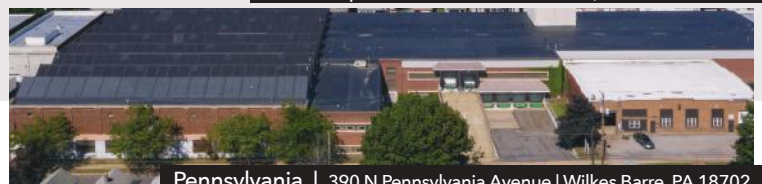

Pennsylvania | 390 N Pennsylvania Avenue | Wilkes Barre, PA 18702