



The System
with profile
since 1965

Introducing... Fabric Flex Framing System

For Silicone Edge
Graphics (SEG)

Your Fabric...
Our Framing System!

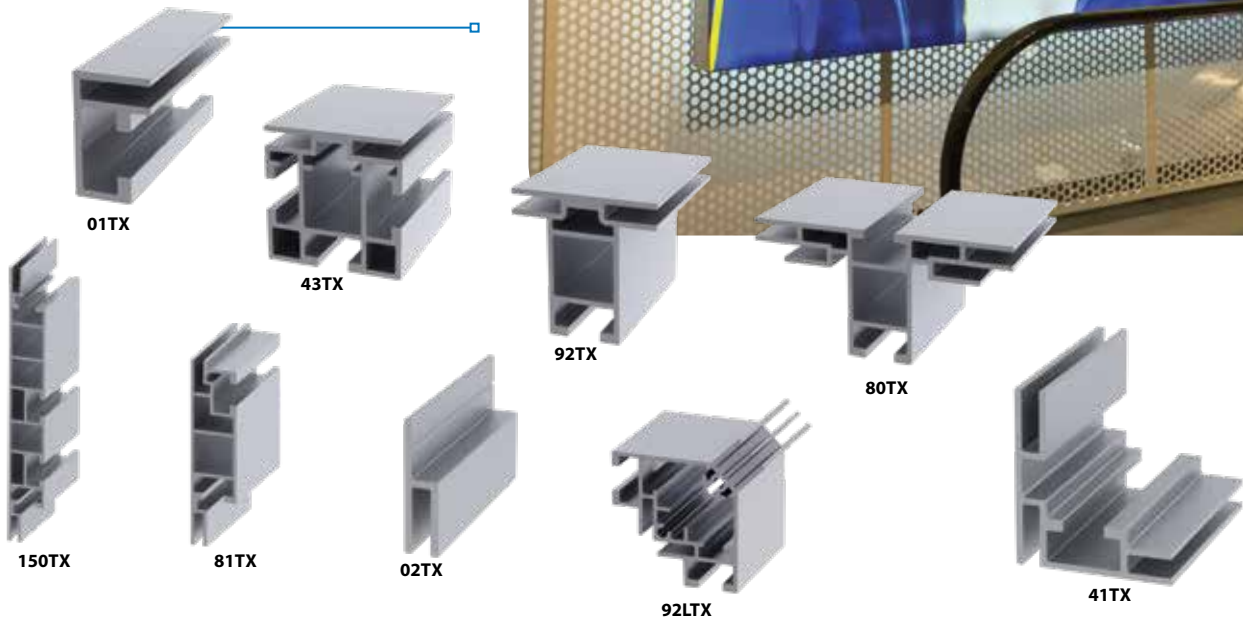

10 Aluminum Profile Options for
Single, Double Sided Signage with or without LED Illuminations & Cube Application









2 OPTIONS TO CHOOSE FROM!

Buy Components In Bulk or Mitered Frames Shipped Knock Down
Please Inquire



The System with profile
since 1965



FRAME OPTIONS	MOUNTING OPTIONS								LIGHTING OPTIONS	
	Profile Width	Single	Double	FOGA® Exhibition	Free Standing Bases	Wall	Hanging	Illuminated	Non-Illuminated	
 FSB01TX-CL	15.5mm (.61")	✓	✗	✗	✗	✓	✗	✗	✓	
 FSB41TX-CL	40mm (1.58")	✓	✗	✗	✗	✓	✓	✓	✓	
 FSB43TX-CL	40mm (1.58")	✓	✓	✓ <i>For use with 194 Series</i>	✓	✗	✓	✗	✓	
 FSB92TX-CL	40mm (1.58")	✓	✓	✓ <i>For use with 194 Series</i>	✓	✓	✓	✗	✓	
 FSB80TX-CL	80mm (3.15")	✗	✓	✓ <i>For use with 80S</i>	✓	✗	✓	✗	✓	
 FSB81TX-CL	80mm (3.15")	✓	✗	✓ <i>For use with 80S</i>	✓	✓	✓	✓	✓	
 FSB150TX-CL	150mm (5.91")	✓	✓	✗	✓	✓	✓	✓	✓	
 FSB02TX-CL	n/a	✓	✓	✗	✗	✗	✗	✓	✓	
				<i>For use with wood frames</i>						
 FSB92LTX-CL	n/a	Cube		✓	✗	✗	✓	✓	✓	
				<i>For 4-sided cubes & exhibition. Design assistance required</i>						

SEG Profiles

All Dimension Are In Millimeters

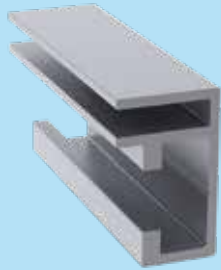

FSB01TX-CL



Part #	Finish	Length	Graphic Sides	Corner	Mounting Options
FSB01TX-CL	Clear Anodized Aluminum	8 Ft.	Non-Illuminated Single	FS613	Wall only Screw to the wall

CONVERSION CHART

MM	4	15.5	25.5
FRACTION	5/32"	39/64"	1"
DECIMAL	.16"	.61"	1"

FSB41TX-CL

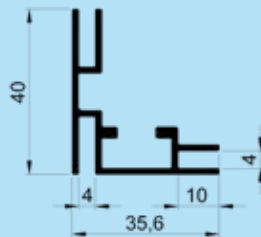
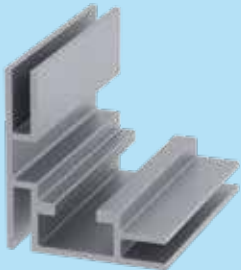

Part #	Finish	Length	Graphic Sides	Corner	Mounting Options
FSB41TX-CL	Clear Anodized Aluminum	8 Ft.	Single Illuminated, Double Non-Illuminated	FS613	Freestanding, Wall or Hanging

CONVERSION CHART

MM	10	35.6	40
FRACTION	25/64"	1-13/32"	1-37/64"
DECIMAL	.394"	1.402"	1.58"

All Dimension Are In Millimeters

SEG Profiles



FSB43TX-CL

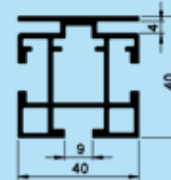

CONVERSION CHART

MM	4	9	40
FRACTION	5/32"	23/64"	1-37/64"
DECIMAL	.16"	.35"	1.58"

Part #	Finish	Length	Graphic Sides	Corner	Mounting Options
FSB43TX-CL	Clear Anodized Aluminum	16 Ft.	Non-Illuminated Single or Double	FS613	Floor, Hanging & Foga 194 Series



FSB92TX-CL

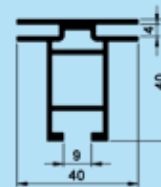

CONVERSION CHART

MM	4	9	40
FRACTION	5/32"	23/64"	1-37/64"
DECIMAL	.16"	.35"	1.58"

Part #	Finish	Length	Graphic Sides	Corner	Mounting Options
FSB92TX-CL	Clear Anodized Aluminum	16 Ft.	Non-Illuminated Double	FS614	Freestanding, Wall or Hanging



FSB80TX-CL

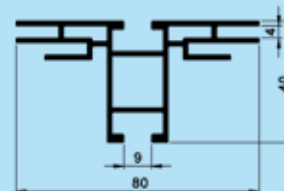

CONVERSION CHART

MM	4	9	40	80
FRACTION	5/32"	23/64"	1-37/64"	3-5/32"
DECIMAL	.16"	.35"	1.58"	3.15"

Part #	Finish	Length	Graphic Sides	Corner	Mounting Options
FSB80TX-CL	Clear Anodized Aluminum	16 Ft.	Non-Illuminated Double	FS614	Freestanding or Hanging

SEG Profiles

All Dimension Are In Millimeters

FSB81TX-CL

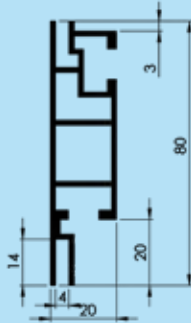

Part #	Finish	Length	Graphic Sides	Corner	Mounting Options
FSB81TX-CL	Clear Anodized Aluminum	8 Ft.	Single Illuminated, Double Non-Illuminated	FS613	Freestanding, Wall or Hanging

CONVERSION CHART

MM	3	4	14	20	80
FRACTION	15/128"	5/32"	35/64"	25/32"	3-5/32"
DECIMAL	0.1181"	.16"	.55"	.79"	3.15"

FSB150TX-CL

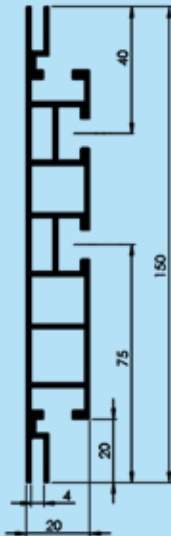

Part #	Finish	Length	Graphic Sides	Corner	Mounting Options
FSB150TX-CL	Clear Anodized Aluminum	8 Ft.	Single Illuminated, Double Non-Illuminated	FS613	Freestanding, Wall or Hanging

CONVERSION CHART

MM	4	20	40	75	80	150
FRACTION	5/32"	25/32"	1-37/64"	2-61/64"	3-5/32"	5-29/32"
DECIMAL	.16"	.79"	1.58"	2.95"	3.15"	5.91"

All Dimension Are In Millimeters



FSB02TX-CL For Wood Frame Applications

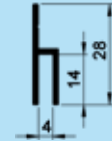

CONVERSION CHART

MM	3	4	12	14	28
FRACTION	15/128"	5/32"	15/32"	35/64"	1-7/64"
DECIMAL	.1181	.16"	.472"	.55"	1.10"

Part #	Finish	Length	Graphic Sides	Corner	Mounting Options
FSB02TX-CL	Clear Anodized Aluminum	16 Ft.	Single or Double	Miter To Mount Inside Frame	Mounts Inside Your Own Frame

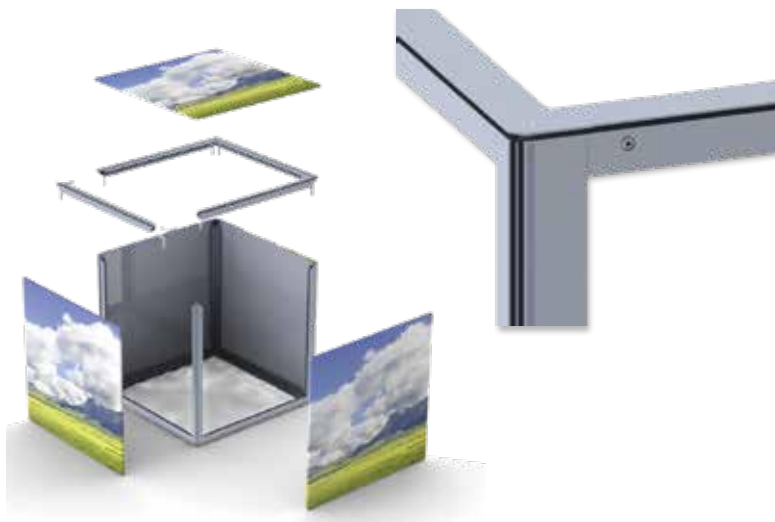

FSB92LTX-CL

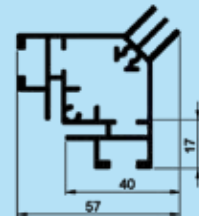
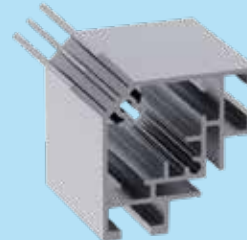

CONVERSION CHART

MM	17	40	57
FRACTION	11/16"	1-37/64"	2-1/4"
DECIMAL	.67"	1.58"	2.25"

Part #	Finish	Length	Graphic Sides	Mounting Options
FSB92LTX-CL	Clear Anodized Aluminum	16 Ft.	For Cubes	Hanging Options - Please Call To Discuss

Required Accessories

Part #	Description
FS614	Corner Coupling, 3 Per Corner Required
FST92LTX	Steel End Cap

Accessories

CORNERS

FS613

Works With:
FSB01TX, FSB41TX, FSB81TX,
FSB150TX (2 per corner required),
FSB43TX



FS614

Works With:
FSB92TX, FSB80TX, FSB92TX



WALL BRACKET

FS520

Works With:
FSB41TX, FSB81TX, FSB92TX,
FSB80TX, FSB150TX



SUPPORT BEAM KITS

FS01CL-KIT-8 (8 Ft. Length) FS01CL-KIT-16 (16 Ft. Length)

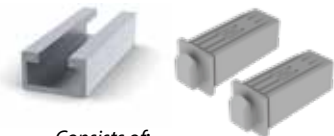

Consists of:
(1) FS01CL & (2) FS600QF
-16 ft. kit includes (1) FS604 splice connector

8 Ft. or 16 Ft. Lengths
Works With:
FSB01TX

FS90CL-KIT-8 (8 Ft. Length) FS90CL-KIT-16 (16 Ft. Length)

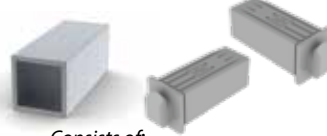

Consists of:
(1) FS90CL, (1) FS600QFL & (1) FS600QFR
-16 ft. kit includes (1) FS609 splice connector

8 Ft. or 16 Ft. Lengths
Works With:
FSB92TX, FSB81TX, FSB150TX,
FSB80TX, FSB43TX

SPLICE CONNECTOR

FS609QF

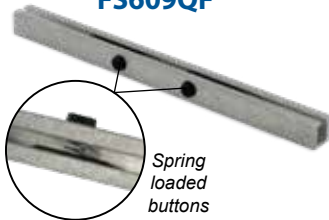

Works With:
FSB81TX,
FSB150TX

BASES

FSB-2200B



Nominal
17-3/4" x 3-3/4" x 3/16"
Thick Rectangle

*Ideal for Signage Under
8' High, Use Every 3'*

FSB-740B



400mm (15-3/4") x
400mm (15-3/4") x
5mm (13/64")
Thick Square

*Ideal for Signage Over
8' High, Use Every 3'*

LOCKING HOOKS WITH CABLE

FWH-8-PC (8 Ft. Length) FWH-15-PC (15 Ft. Length)

8 Ft. or 15 Ft. Lengths

Works With:
FSB73TX, FSB92TX, FSB80TX, FSB81TX,
FSB150TX, FSB04TX, FSB41TX

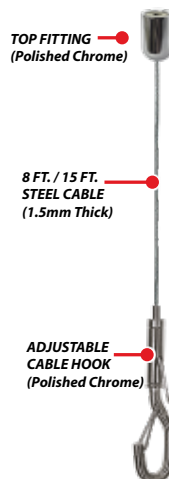

GSH-8 (8 Ft. Length) GSH-15 (15 Ft. Length)

8 Ft. or 15 Ft. Lengths

Works With:
FSB73TX, FSB92TX, FSB80TX, FSB81TX,
FSB150TX, FSB04TX, FSB41TX





24V **US FAB LED STRIP**

2 Powerful LED Options

Illuminates SEG Graphics Evenly Without Hot Spots

- Designed to fit inside the frame of FSB81TX and FSB150TX-CL.
- Comes complete with finger lift hi-tack acrylic permanent tape.

STANDARD

DELUXE

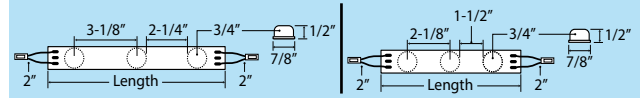

Specially designed lens spreads light evenly, creating no hot spots or shadows

- The overall width of your frame should not exceed 96", but the brightness level is greatest at 50" or less.
- Do not exceed running more lights than suggested because of voltage drop. However, if you "split" the load using a 2-way connector then you can have more lights on each side. The 2-way connector requires 2 power linking cables (LED-FBF-PWL*) that work with these lights.

Lighting Specifications

Color Temperature	CW: 6000K-7000K
Beam Spread	40°
Initial Lumens	LED-FBF83-CW: 550-650 per ft. LED-FBF14-CW: 1000-1100 per ft. LED-FBF7-DLX-CW: 550-650 per ft. LED-FBF84-DLX-CW: 700-800 per ft. LED-FBF18-DLX-CW: 2000-2100 per ft.
Color Rendering Index	75+
Rated Average Life	30,000 hrs.
Constant	Voltage
Chip Size	SMD3535
Warranty	3 Years Limited

Part #	Length	Color Temp	# Of LED Modules	Total Wattage	Max # Can Connect
STANDARD BRIGHTNESS					
LED-FBF83-CW	8"	Cool White	3	7	10
LED-FBF14-CW	14"	Cool White	5	10	7
DELUXE BRIGHTNESS					
LED-FBF7-DLX-CW	6-1/8"	Cool White	3	7	8
LED-FBF84-DLX-CW	8"	Cool White	4	8	10
LED-FBF18-DLX-CW	18-1/2"	Cool White	9	20	4

Accessories

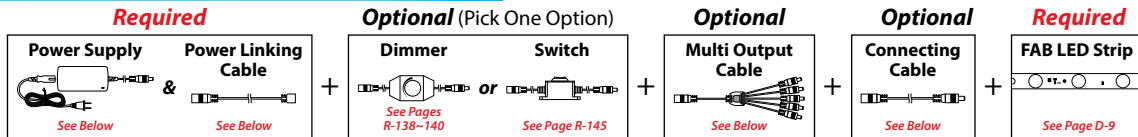

Required

Power Supplies

LED-24V-2.5A-HWSL Is So Slim It Can Now Be Concealed Inside The SEG Frame

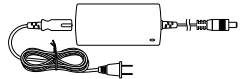

Part #	Type	Amps	Volts	Watts	Dimensions
LED-24V-2.5A-HWSL	Hardwire	2.5A	24V	60W	11.8" L x 1.25" W x 0.78" H
LED-24V-3A	Desktop	3A	24V	72W	4.68" L x 2.34" W x 1.48" H
LED-24V-4A	Desktop	4A	24V	96W	6.77" L x 2.83" W x 1.57" H
LED-24V-6A	Desktop	6A	24V	144W	6.77" L x 2.83" W x 1.57" H

For Product Details & More Power Options, See Pages R-133~R-137

Other Options: Plug In | Hardwire | Hardwire Dimmable | Rechargeable Battery

Power Linking Cable

Required for power supplies, dimmers & multi output cables.



Part #	Works With	Description	Overall Length	Finish
LED-FBF-PWL18	FAB LED Strip	Power Link Cable	18"	Black
LED-FBF-PWL40	FAB LED Strip		40"	Black

Optional

Multi Output Cables

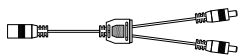

Part #	Description	Finish	Arms Size	# of Arms	Overall Length	Max # of Power Linking Cables
Power Linking Cable Required For Each Outlet						
LED-2WAY-BK	2-Way Sweep	Black	3"	2	6-3/4"	2

Connecting Cables

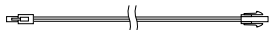

Part #	Works With	Description	Finish	Length
LED-FBF-CC-12	FAB LED Strip	Allows the designer to get	Black & Red	12"
LED-FBF-CC-18	FAB LED Strip	around unlit areas without	Black & Red	18"
LED-FBF-CC-40	FAB LED Strip	multiple power supplies	Black & Red	40"

Wire Bushing



Part #	Color	Dimensions		
		Height	Width	Max. Panel Thickness
FSB-WB	Black	.500"	.465"	.156"

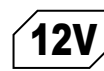

LED Ladder Backlight System

Available Lengths: Nominal 20" & 40"

Material: Aluminum with White Coating

- Ultra Bright: Latest 2835 chip technology produces up to 1440 lumens per length.
- Works with FSB41TX-CL (See Page D-4), FSB81TX-CL & FSB150TX-CL (See Page D-6).
- Backlight as little as 1-1/2" depth without hotspots
- Easily connect ladders together for versatile sizing
- No heat sink required

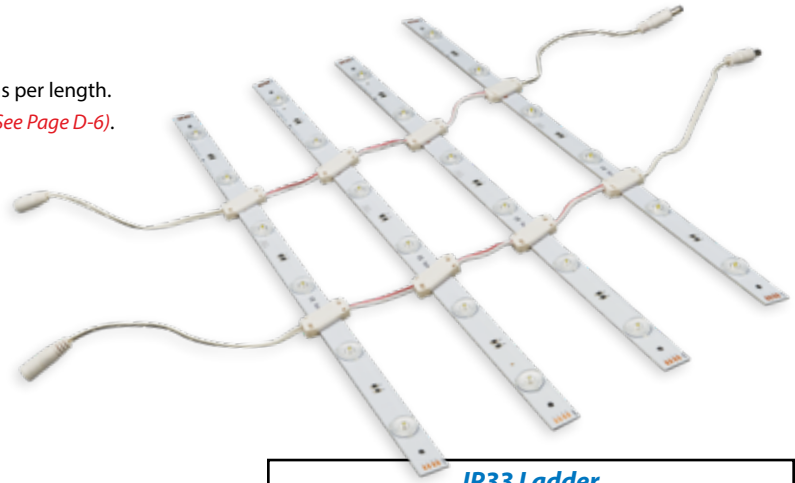

IP33 Ladder
Limited Protection From Touch, Tools & Splashing Water

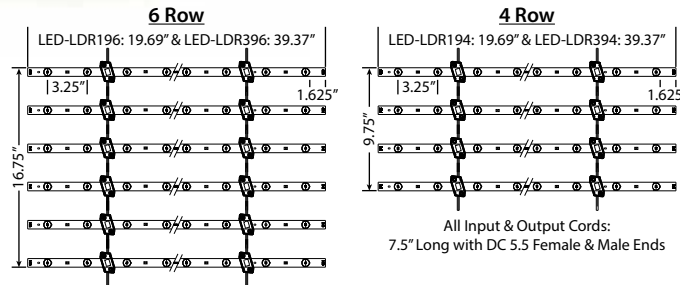

Part #	Color Temp	Description	# Of LED Chips	Total Wattage	Max # Can Connect
LED-LDR194-CW	Cool White	4- Row 19.69" Length	24	29	5
LED-LDR196-CW	Cool White	6- Row 19.69" Length	36	43	3
LED-LDR394-CW	Cool White	4- Row 39.37" Length	48	58	2.5
LED-LDR396-CW	Cool White	6- Row 39.37" Length	72	86	1.5

Lighting Specifications

Color Temperature	CW: 6500K
Beam Spread	168°
Lumens	436 per ft.
Color Rendering Index	85+
Rated Average Life	50,000 hrs.
Constant	Voltage
Chip Size	2835

Required

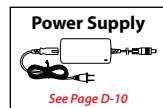

Optional (Pick One Option)

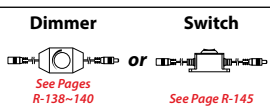

Required

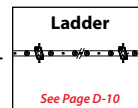

Required

Power Supplies (IP20)

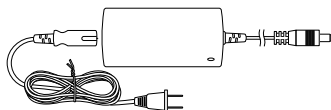

Part #	Type	Amps	Volts	Watts	Dimensions
LED-12V-6A	Desktop	6A	12V	72W	4.68"L x 2.34"W x 1.48"H
LED-12V-9A	Desktop	9A	12V	108W	6.77"L x 2.83"W x 1.57"H

For Product Details & More Power Options, See Pages R-133~137
Other Options: Plug In | Hardwire | Hardwire Dimmable | Rechargeable Battery

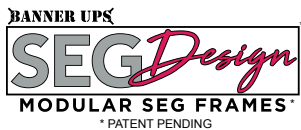

SEG Made Simple...and Beautiful!

Stock Color: Silver Aluminum

Material: ABS



Graphic NOT included



Modular system - fast and easy to assemble

- No assembly tools needed. Snaps together instantly.
- Can be pressure fit, screw-secured, or glued.
- Corner pieces and T-Connectors make unlimited size and shapes easy.
- No mitered corners / all straight cut sides.
- Cut with any hand or power saw. Custom sizes a breeze!



Slide rails into corner brackets



Simply snap together corners

Superior to Aluminum

- Lower total cost than aluminum.
- 100% MADE IN THE USA (PAT. pending)
- Lighter weight than aluminum - easier to ship and hang.
- Breaks down to shippable sizes - NO UPS/FedEx surcharge.
- No hidden hardware or cutting charges.

Environmentally-friendly polymer

- ABS, Non-PVC recyclable polymer

Enhances the value of complementary products:

- Ask us for a list of approved recommend textile media.
- Works with all Latex, Dye Sub, and Eco-Solvent printers.



Unlimited length with T-Connectors



Cleat for hanging frame on wall

Add DESIGN to your SEG frames - wrapable, paintable, designable!

- Add color easily with common spray paint (Krylon Fusion 28 colors*)
- Match customers logo or image color!
- Let your creativity flow! "Upsell" through beautiful design.



Krylon is a registered trademark of Sherwin-Williams*



Works great with KederTape™ - a complete simple solution

- Enter the SEG market NOW, with no equipment cost.

NO SEWING NEEDED!

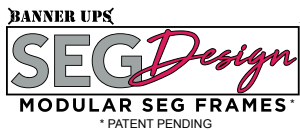

SEG Made Simple...and Beautiful!

Stock Color: Silver Aluminum
Material: ABS

- Fast & easy to assemble, no mitering!
- Lightweight, easy to ship!
- Paintable, wrappable...designable!
- No aluminum, no tools, no hassle!



Buy SEG Modular Frames In Bulk!

Part #	Description	# Of Pieces Per Case
BU-SEGD15-1824	15mm frame, 18" x 24" O.A.	5
BU-SEGD15-2436	15mm frame, 24" x 36" O.A.	5
BU-SEGD15-3648	15mm frame, 36" x 48" O.A.	5

Create Any Size Frame You Want!

Buy SEG Components Separately in Bulk and Cut Size as Needed!

Part #	Description	# Of Pieces Per Case
BU-SEGD15-R15	15mm side rail, 15"	48
BU-SEGD15-R21	15mm side rail, 21"	48
BU-SEGD15-R33	15mm side rail, 33"	48
BU-SEGD15-R45	15mm side rail, 45"	48
NEW BU-SEGD15-R110	15mm side rail, 110"	60
BU-SEGD15-CORNER	15mm 90° corner	48
NEW BU-SEGD215-STRCON	15mm internal corner	48
BU-SEGD15-TCON	15mm t-connector	48
NEW BU-SEGD215-STRCON	15mm straight connector	48
BU-SEGD15-CLEAT	15mm wall cleat	48

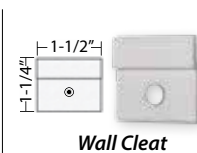
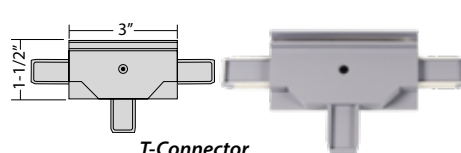
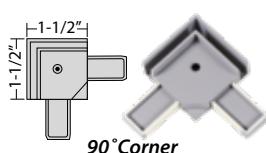
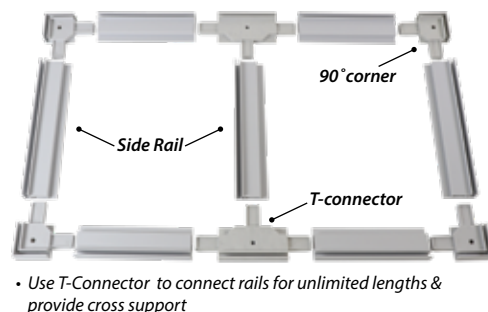
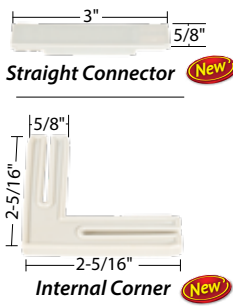

When ordering, take overall frame size and subtract 3" from each rail. (ie) 18" - 3" = 15" rail, 24" - 3" = 21" rail. The 90° corners add 3" to meet overall frame dimension of 18" x 24".



Make Silicone Edge Graphic (SEG) Signs without sewing by using KederTape™!

KederTape™ is a high-quality keder that is laminated with a premium pressure sensitive adhesive which allows the product to be "peel and stick" applied to textiles for SEG (Silicone Edge Graphic) applications. KederTape™ adhesive has been engineered to aggressively adhesive to textiles.



TRY A SEGDESIGN STARTER KIT

BU-STARTKTSEG-1AS

Starter Kit includes:

- (1) 18" x 24" 15mm Frame
- (1) 24" x 36" 15mm Frame
- (1) 8" x 10" Sample Display Frame
- (1) 48 ft. Spool Keder™ Tape
- (6) Wall Cleats



- 1.875" x 3.875" clear tab, folds to 1.875" square shape
- Works great both at corners and along banner edges
- BravoTabs® are a great grommets/eyelet replacement
- Faster to install translates to lower cost
- No neck loop for improved appearance
- Crystal clear banner tab, allowing your color graphics to shine through



Crystal Clear BravoTabs® A Stronger Grommet / Eyelet!

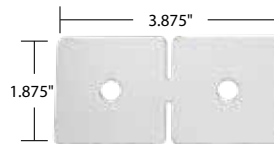

One Size Fits All - Corner and Edges



BravoTab® Corner Mount

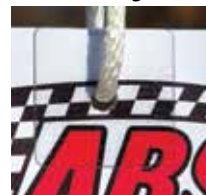

BravoTab® Edge Mount



4 clear tabs per sheet

Part #	# Of Pieces Per Case
BU-BAN017	500



- 1.5" x 3.125" clear tab, folds to 1.5" square shape
- Perfect for hanging posters & indoor banners
- Apply to corners of plastic film and then secure using a rope or stake through the center hole
- 2000 Tabs per dispenser roll; roll liner is perforated every four tabs
- Our most economical tab

Clear Polytabs for high volume jobs

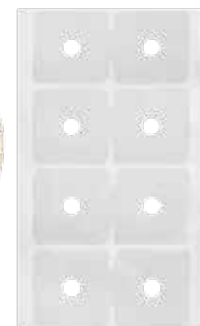
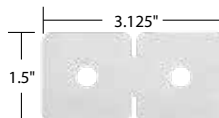

Part #	# Of Pieces Per Case
BU-BAN062	2000



- 1.5" wide, 36 yard clear roll
- Use PowerTape® to create a super strong banner of any length
- Single-sided super strong film. No need to fold hem
- Duplicates the strength of folded hem and double sided banner tape, but eliminates the hassle!
- Eliminate the risk of damage to image by post-print sewing
- Create a perfectly sharp digital banner. No rippled hem
- Fabricate a mighty banner in only 3 minutes

Clear PowerTape® Reinforce banner edges without folding or sewing a hem



Part #	# Of Rolls Per Case
BU-PTAPECLEAR	5

TRY A BANNER UPS® STARTER KIT

Enough for about 20 banners, The Starter Kit will let you give Banner Ups® a good trial and find out why so many banner makers LOVE Banner Ups® when it comes to custom banner finishing products!



100 Banner Ups® Crystal Clear BravoTabs®

Square shape works great on banner edge or corners. Durable for outdoor use. Use with PowerTape for banners over 6 ft.

1 roll of Banner Ups® Clear PowerTape®

Super-strong single sided hem tape. No folding of hem required! Perfect for double-sided banners.

1 Banner Ups® PowerPunch®

Perfectly sized heavy duty hole punch. Tough enough to cleanly punch tab, tape, and media. Great for punching 4mm corrugated plastic or foam board too!

BU-STARTKT4AS



Ultra High Strength Double Sided Clear MegaTape®
Banner hem tape that withstood winds up to 108 MPH!

- 1.5" wide, 30 yard double sided clear roll
- Double sided banner hem reinforcing tape that is made of a super strong film
- Wind tunnel tested - improved MegaTape® banner hem tape withstood winds up to 108 MPH!
- Clear film is less visible / more attractive when used in mesh banners
- Produces a fold-finished banner edge
- Easy to apply banner hem tape. Wears like steel!
- Much cleaner appearance and twice as strong as ordinary double sided banner hem tape.



Part #	# Of Rolls Per Case
BU-MEGATAPE-CL	5



Premium Double Sided Clear TigerTape™
High-performance banner hem tape

- 1" wide, 36 yard length double sided roll
- Double coated polyester (PET) carrier film (.005") on both sides with high deposition of a high tack acrylic pressure sensitive adhesive (PSA)
- A high performance banner hem tape specifically designed for the most demanding bonding applications
- Provides a permanent bond of foams, plastics, metal and composite materials subjected to a broad range of environmental conditions
- Highly UV, temperature and plasticizer resistant making it ideal for banner hemming applications



Part #	# Of Rolls Per Case
BU-TIGTAPE1036	12



PowerPunch® -
The perfect punch for Powertabs®

- Powerful and durable, lightweight to handle
- Portable and much less expensive
- Cut cleanly through tabs, PowerTape® and banner media
- Cuts a 5/16" banner hole
- Easily punch holes in 4mm corrugated plastic and foamboard without deforming the board



Part #
BU-PPUNCH

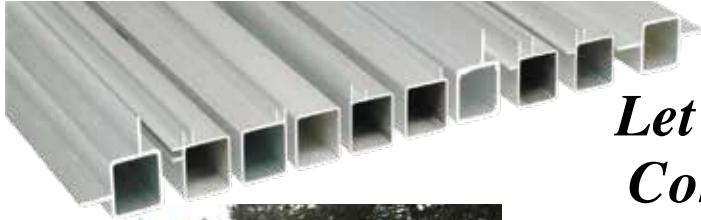

Let Our Simple Concept Form Your Great Idea!

Our Aluminum Framing System is Available in 3/4", 1" & 1-1/2" Square Tubing and corresponding Tubing Connectors & Accessories



Great For:

- ★ *Tradeshows*
- ★ *Greenhouses*
- ★ *Menus*
- ★ *Signs*



To enhance our Aluminum Framing System, we offer full services from design to production. We can help with your design, choosing the most cost effective profiles and connectors, figuring the overall sizes for the highest yield from stock lengths, to packing your order for shipment.

Our experienced design staff can work with the simplest drawings to the newest CAD drawings to produce an aesthetically pleasing, totally functional final product. Our Fabrication Department can cut all tubing to size, notch flanges, and drill or punch holes to exacting standards so the fit and finish is unmatched. Finally, we can help with packing your order so it arrives in excellent condition.



Great Ideas Need Accessories!

Shown 1" Tubing with Cladding Fittings & Wide Variety of LED Lighting Options

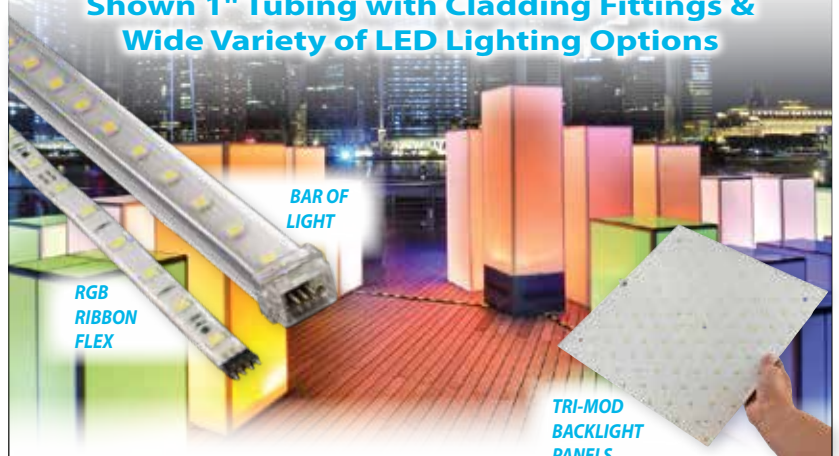

RGB
RIBBON
FLEX

BAR OF
LIGHT

TRI-MOD
BACKLIGHT
PANELS

For more information go to www.outwater.com (see lighting)



3/4" Square Aluminum Tubing

Lengths: 8 Ft.

Square Tube
Wall Thickness: .050

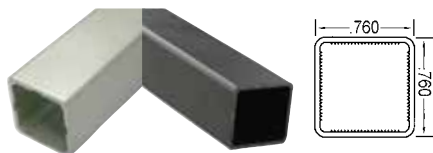

Part #	Finish	Length
AT24-2BK-8	Black Anodized	96"
AT24-2CL-8	Clear Anodized	96"

3/8" Flange
Wall Thickness: .050

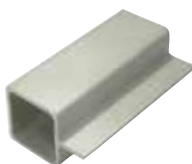

Part #	Finish
AT24-3BK-8	Black Anodized
AT24-3CL-8	Clear Anodized

3/8" 90° Flange
Wall Thickness: .050

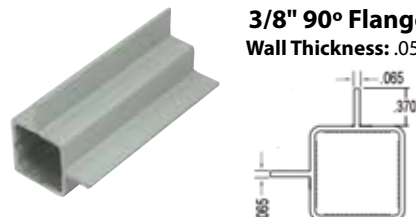

Part #	Finish
AT24-4BK-8	Black Anodized
AT24-4CL-8	Clear Anodized

Clear anodized finish is suitable for indoor and outdoor use. Black for indoor only.

3/4" Tubing Connectors & Accessories

Material: Dupont™ Super Toughened Nylon
Available in Black or Grey



2Way Right Angle Connector

Part #	Finish
F24521BK	Black
F24521GY	Grey



3Way Tee Connector

Part #	Finish
F24532BK	Black
F24532GY	Grey

3Way Corner Connector



Part #	Finish
F24533BK	Black
F24533GY	Grey

Straight Base Connector



Part #	Finish
F245323BK	Black
F245323GY	Grey

4Way Connector



Part #	Finish
F24545BK	Black
F24545GY	Grey

Straight Connector



Part #	Finish
F24500BK	Black
F24500GY	Grey

Perpendicular Joiner/Splicer For 3/4" At Tubing W/3/4" Long Self Tapping Screw

ALLOWS TO ATTACH ANY TUBING AT A PERPENDICULAR ANGLE

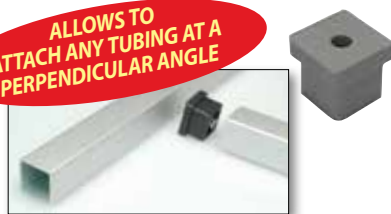

Part #	Finish
F245112MCBK	Black
F245112MCGY	Grey

End Cap

Material:
Low-Density Polyethylene



Part #	Color
DNW-S24-BK	Black

4Way Cross Connector



Part #	Finish
F24544BK	Black
F24544GY	Grey

Cavity Insert For 3/4" Connector Legs

This accessory fits any 3/4" connector increasing surface area for a tighter fit



Part #	Finish
F24007BK	Black
F24007GY	Grey

6Way Connector



Part #	Finish
F24568BK	Black
F24568GY	Grey

Aluminum Framing System

1" Square Aluminum Tubing *Wall Thickness: .044"*

Lengths: 8 Ft.

Double Channel 90° Fits 1/8" Panel

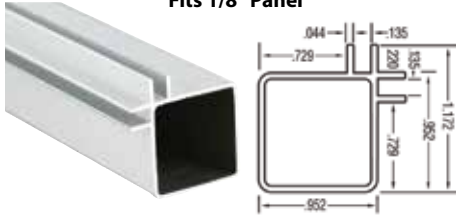

Part #
AT-14CL-8

Finish
Clear
Anodized

Single Channel With 1/4" Flange Fits 1/8" Panel

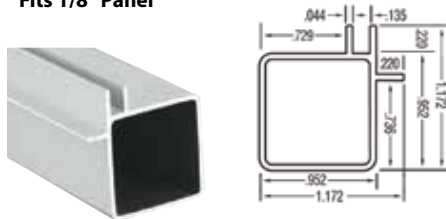

Part #
AT-15CL-8

Finish
Clear
Anodized

Single Channel Fits 1/8" Panel

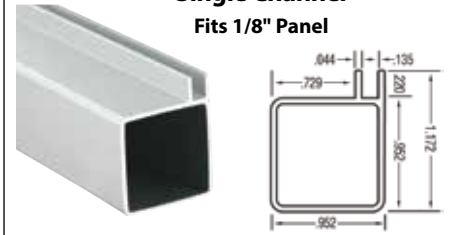

Part #
AT-17CL-8

Finish
Clear
Anodized

Single Channel With 1/4" Flange Fits 1/4" Panel

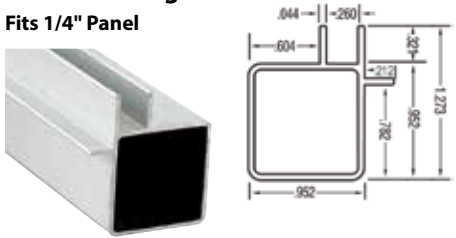

Part #
AT-16CL-8

Finish
Clear
Anodized

Single Channel Fits 1/4" Panel

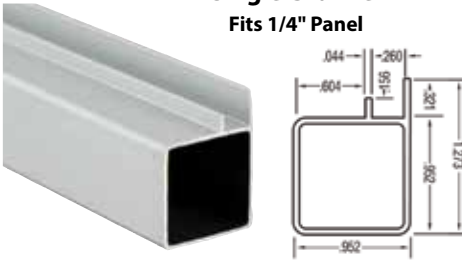

Part #
AT-18CL-8

Finish
Clear
Anodized

1/4" Flange

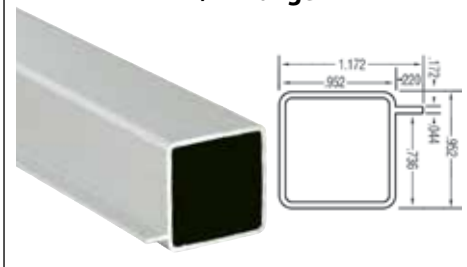

Part #
AT-19CL-8

Finish
Clear
Anodized

Sliding Door Track

Peel & Stick
Adhesive

NOTE:
Rough Opening
Less 7/8" = Door Size

1 Roller
Per Running
Foot Included

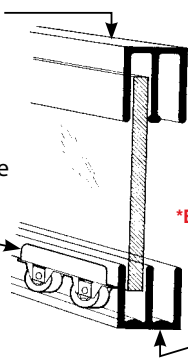

Styrene Track W/Rollers & Peel-N-Stick Adhesive

Colors Available

*BK - Black *SG - Silver Gray

Peel & Stick
Adhesive Mount
to AT Tubing on
page B-19

With Adhesive - Available
In 4 & 8 Ft. Lengths

Part #	Length
MT38-A4*	4 ft.
MT38-A8*	8 ft.

Plastic Finger Pulls

With high quality pressure sensitive adhesive backing. No holes to drill. Peel off protective backing paper and apply directly to surface of glass.



Part #	Finish
170-BK	Black
170-CL	Clear

Packed 100 pieces per carton.
Broken box fee (BB2) for less than full carton.

1" Square Aluminum Tubing *Wall Thickness: .065"*

We Can Cut To Size - Please Inquire

Lengths: 8 Ft.

Square Tube

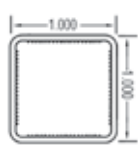
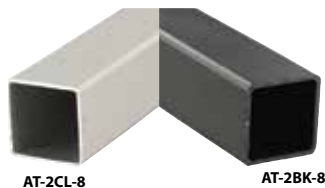

Part #	Finish
AT-2CL-8	Clear Anodized
AT-2BK-8	Black Anodized

5/8" Flange

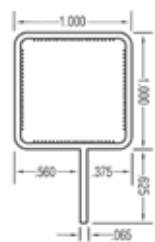

Part #	Finish
AT-3CL-8	Clear Anodized
AT-3BK-8	Black Anodized

Single Channel Fits 7/32" Panel

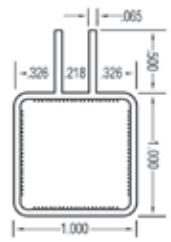
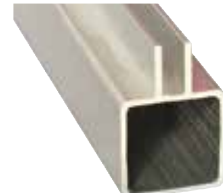

Part #	Finish
AT-6CL-8	Clear Anodized
AT-6BK-8	Black Anodized

5/8" 90° Flanges



Part #	Finish
AT-4CL-8	Clear Anodized
AT-4BK-8	Black Anodized

5/8" 180° Flanges

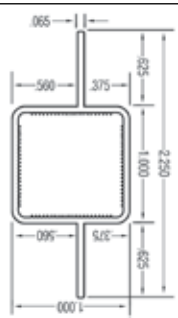

Part #	Finish
AT-5CL-8	Clear Anodized
AT-5BK-8	Black Anodized

Double Channel 180° Fits 1/4" Panel

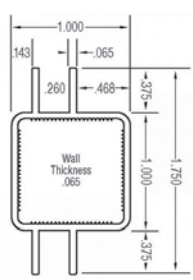
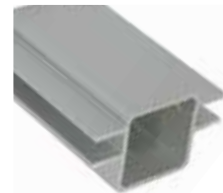

Part #	Finish
AT-7CL-8	Clear Anodized
AT-7BK-8	Black Anodized

Triple Channel Fits 1/4" Panel

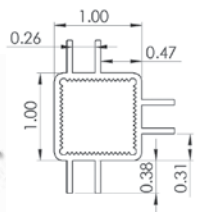
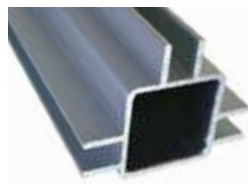

Part #	Finish
AT-8CL-8	Clear Anodized
AT-8BK-8	Black Anodized

Slotted 1" Tubing



Part #	Finish
AT-9CL-8	Clear Anodized
AT-9BK-8	Black Anodized

Slots are 1/8" x 1/2"-1" on center for hardware support

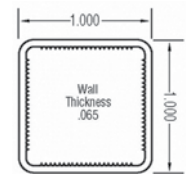

MAY BE USED WITH:

Steel Shelf Brackets



Part #	Description	Finish/Color
Tap-In - .080 Thick Material		
6KB-BC	6" Long Bracket	Bright Chrome
8KB-BC	8" Long Bracket	Bright Chrome
10KB-BC	10" Long Bracket	Bright Chrome
12KB-BC	12" Long Bracket	Bright Chrome
12KB-SC	12" Long Bracket	Satin Chrome
14KB-BC	14" Long Bracket	Bright Chrome
14KB-WH	14" Long Bracket	White

Note: For All Tubing

Clear anodized finish is suitable for indoor and outdoor use. Black for indoor only.

1" Tubing Connectors & Accessories

Material: Dupont™ Super Toughened Nylon
Available in Black or Grey

2Way Right Angle Connector



Part #	Color
F521BK	Black
F521GY	Grey

3Way Tee Connector



Part #	Color
F532BK	Black
F532GY	Grey

** 3Way Connector w/Heavy Duty Caster Socket



****NOTE:** #F533C will accept a 3/8" diameter x 1" long friction fit caster stem (not included)
See Below for Caster

Part #	Color
F533C/BK	Black
F533C/GY	Grey

3Way Corner Connector



Part #	Color
F533BK	Black
F533GY	Grey

4Way Cross Connector



Part #	Color
F544BK	Black
F544GY	Grey

4Way Connector



Part #	Color
F545BK	Black
F545GY	Grey

3Way Connector w/2-3/8" Dia Caster w/Friction Ring Stem



Without Brake

Part #	Color
F533C/BK-CST	Black
F533C/GY-CST	Grey

With Brake

Part #	Color
F533C/BK-CSTB	Black
F533C/GY-CSTB	Grey

5Way Connector



Part #	Color
F558BK	Black
F558GY	Grey

6Way Connector

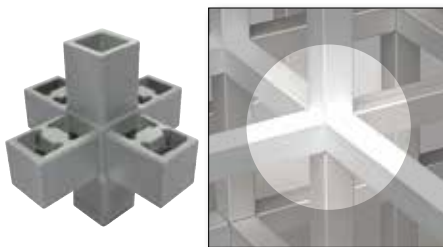

Part #	Color
F568BK	Black
F568GY	Grey

3Way Connector w/Leveler 1/4-20 x 1" Long



1-3/8" Base Dia.
w/Thread Stem & Insert

Part #	Color
F533C/BK-LEV	Black
F533C/GY-LEV	Grey

1" Tubing Connectors & Accessories

Material: Dupont™ Super Toughened Nylon
Available in Black or Grey

90° Base Connector



Part #	Color
F5323SPBK	Black
F5323SPGY	Grey

Straight Base Connector



Part #	Color
F5323BK	Black
F5323GY	Grey

Perpendicular Joiner/Splicer For 1" AT Tubing with 1 x #8 3/4" Long Self Tapping Screw

ALLOWS TO ATTACH ANY TUBING AT A PERPENDICULAR ANGLE!



Part #	Color
F5112MCBK	Black
F5112MCGY	Grey

The Invisible Coupling



Part #	Color
F5101BK	Black
F5101GY	Grey

Straight Connector



Part #	Color
F500BK	Black
F500GY	Grey

Stack Plug For Use With F533C Connector

GREAT FOR STACKING CASES!



Part #	Color
F4PSPGY	Grey

All Metal Heavy Duty Shelf Rest For Glass Or Wood Shelving



Part #	Finish
F514BK	Black Anodized
F514CL	Clear Anodized

End Cap



Material:
Low-Density
Polyethylene

Part #	Color
SHK-32S-BK	Black

U-Clip

4" Lengths
Aluminum Material - Satin Finish

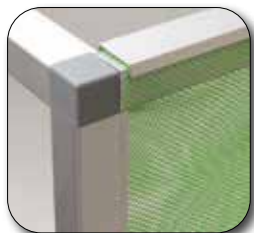

FMJ557-4-S

Fits over AT tubing - will hold fabric, plastic sheeting and netting in place!

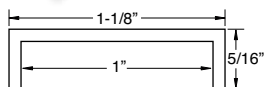

Cavity Insert For 1" Connector Legs

This accessory fits any 1" connector increasing surface area for a tighter fit



Part #	Color
F007BK	Black
F007GY	Grey

1" Tubing Connectors & Accessories



Casing Trim



All cast trim sides can come apart for easy access to insert or remove signage



Cast trim with adhesive tape is shown attached to our 1" tubing

**Casing Trim For
1/4" Panels 1" Base**
Available in Black or Nickel
With Adhesive Tape
Material: PVC 6' lengths



Part #	Finish
CT8NC	Nickel
CT8BK	Black

**Casing Trim for
1/2" Panels 1" Base**
Available in Black or Nickel
With Adhesive Tape
Material: PVC 6' lengths



Part #	Finish
CT16NC	Nickel
CT16BK	Black

**Casing Trim for
3/4" Panels 1" Base**
Available in Black or Nickel
With Adhesive Tape
Material: PVC 6' lengths



Part #	Finish
CT24NC	Nickel
CT24BK	Black

Material: Dupont™ Super Toughened Nylon
Available in Black or Grey

Adjustable 2Way Connector

Material: PVC

15° Incremental locking from 90° to 180° for 1" Tubing



Part #	Finish
FJ22BK	Black
FJ22GY	Grey

Adjustable Tee Style Connector With Rotating Base Vertical/Horizontal For 1" Tubing

Material: PVC

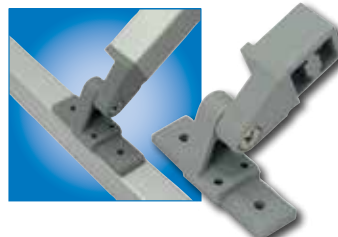

Part #	Finish
FJ32BK	Black
FJ32GY	Grey

Adjustable 2Way In-Line Base Connector

For 1" tubing to connect with another tube at multiple angles
Material: PVC



Part #	Finish
FJ31BK	Black
FJ31GY	Grey

Adjustable 2Way Connector W/Locking Nut For 1" Tube

CAPABLE OF 280° RADIUS

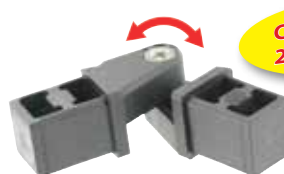

Part #	Color
F52AJNBK	Black
F52AJNGY	Grey

1-1/2" Heavy Duty Aluminum Tubing

Wall Thickness: 1/8" • Lengths: 8 Ft.

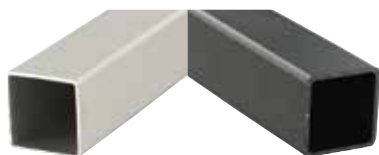

AT48-2CL-8

AT48-2BK-8



Part #	Finish
AT48-2CL-8	Clear Anodized
AT48-2BK-8	Black Anodized

Clear anodized finish is suitable for indoor and outdoor use. Black for indoor only.

1-1/2" Tubing Connectors & Accessories

Material: Dupont™ Super Toughened Nylon
Available in Black or Grey

Connectors fit most 1-1/2" O.D. Aluminum or Steel Tubing with 1/8" wall thickness



2 Way Right Angle Connector

Part #	Color
F48521BK	Black
F48521GY	Grey

3 Way Corner Connector



Part #	Color
F48533BK	Black
F48533GY	Grey



Straight Connector

Part #	Color
F48500GY	Grey
F48500BK	Black



3 Way Tee Connector



Part #	Color
F48532BK	Black
F48532GY	Grey

End Cap



Material: Low-Density Polyethylene

Part #	Color
SHK-48S-BK	Black



4 Way Connector

Part #	Color
F48545BK	Black
F48545GY	Grey

Perpendicular Joiner/Splicer



Part #	Color
F485112MCBK	Black
F485112MCGY	Grey

Uses 4 x #10 1-1/4" Long Self Tapping Screws Sold Separately



FMC48-SCREWS



PROTOTYPE SAMPLES

We are happy to provide samples for prototypes & design builds.
- Please Inquire

Any Angle, Any Panel, Any Display



- Join panels in thicknesses ranging from 1/8" to 3/4"!
- The Klem® connector makes it easy to create angles from 90° to 270°!
- Ideal for straight or curved walls, prisms, squares, cubes, pyramids, domes or any type of display!
- Made of nickel plated zinc alloy and synthetic rubber inserts. The Klem® connector provides great strength and long term durability.
- Standard gap between panels
Mini: 1/2"
Super: 3/4"
- To Close gap between panels, Notch the panels
Mini: 1/4" x 15/16"
Super: 5/16" x 1-3/8"



MULTIPLE PANELS

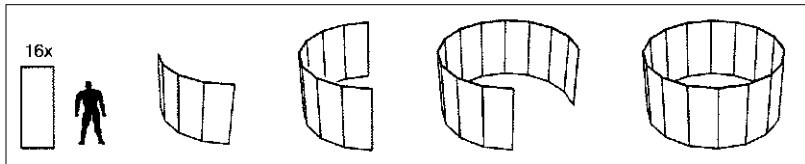

SHOWCASE



PARTITION



BMW SHOWROOM IN AUSTRIA



MUSEUMS & GALLERIES



TRADE SHOWS



ANY PANEL! ANY ANGLE! ANY DISPLAY!

MINI klem®

For panel thicknesses from 1/8" to 5/16"

Part #

7123M.*

* Please specify panel size

2 = 1/8", 4 = 3/16", 6 = 1/4", 8 = 5/16"

Example: for 1/4" panels, Part# is 7123M-6

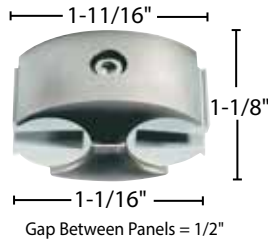

SUPER klem®

For panel thicknesses from 1/4" to 3/4"

Part #

7123S.*

* Please specify panel size

6 = 1/4", 10 = 3/8", 12 = 1/2", 16 = 5/8", 19 = 3/4"

Example: for 1/2" panels, Part# is 7123S-12



BODIES ONLY without inserts

MINI KLEM
7123M



Fits 3/4" Tubing

SUPER KLEM
7123S

Fits 1-1/8" Tubing

BODY WITH LEVELING FOOT

MINI KLEM
7123M-LF

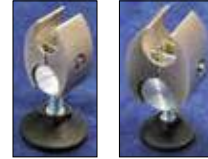

To be used with a single insert or tubing

SUPER KLEM
7123S-LF

INSERT PAIRS ONLY

MINI KLEM
0802PR = 1/8"
0804PR = 3/16"
0806PR = 1/4"
0808PR = 5/16"



SUPER KLEM
0206PR = 1/4"
0210PR = 3/8"
0212PR = 1/2"
0216PR = 5/8"
0219PR = 3/4"

BODY WITH TWIN WHEEL CASTER w/BRAKE

MINI KLEM
7123M-CSTR



Caster Diameter is 2" - Load Rating = 75 lbs per caster
To be used with a single insert or tubing

SUPER KLEM
7123S-CSTR

SINGLE INSERTS ONLY

MINI KLEM
0802 = 1/8"
0804 = 3/16"
0806 = 1/4"
0808 = 5/16"



To be used when connecting panels

SUPER KLEM
0206 = 1/4"
0210 = 3/8"
0212 = 1/2"
0216 = 5/8"
0219 = 3/4"

BODY WITH WALL MOUNT

MINI KLEM
7123M-WM



To be used with a single insert or tubing

SUPER KLEM
7123S-WM

HEX KEY

MINI KLEM
0160



SUPER KLEM
0170

TUBING INSERTS ONLY

MINI KLEM
0713
1/2" ROUND TUBING



To be used when connecting tubes.

SUPER KLEM
0320
3/4" ROUND TUBING

NUTS AND BOLTS

MINI KLEM
7123M-NB



SUPER KLEM
7123S-NB

MANY CONNECTION OPTIONS!



TUBE TO TUBE

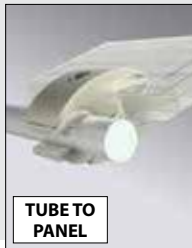

TUBE TO PANEL



3-WAY PANEL



4-WAY PANEL



CASTER



LEVELING FOOT



WALL MOUNT

Classic Urn Stanchions

**WITH CRUSHED VELOUR
OR BRAIDED ROPE
GUIDANCE**

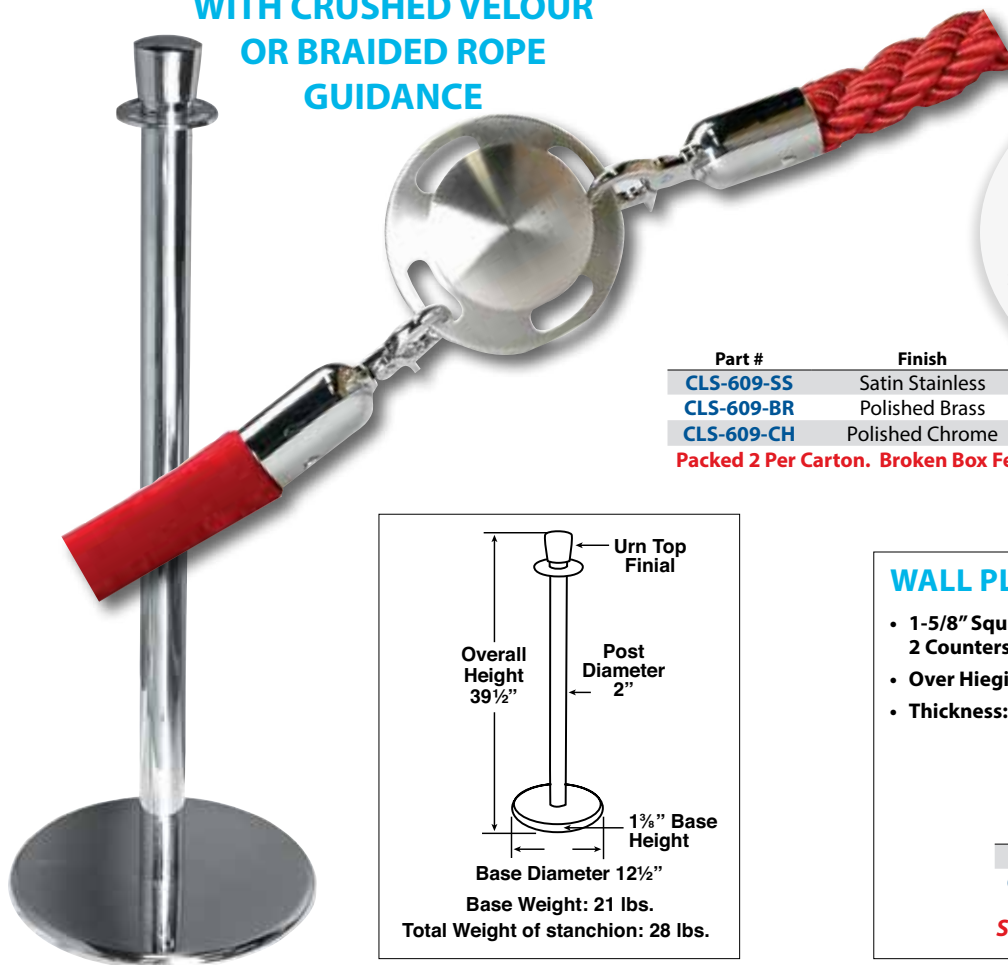

Part #	Finish
CLS-609-SS	Satin Stainless
CLS-609-BR	Polished Brass
CLS-609-CH	Polished Chrome

Packed 2 Per Carton. Broken Box Fee

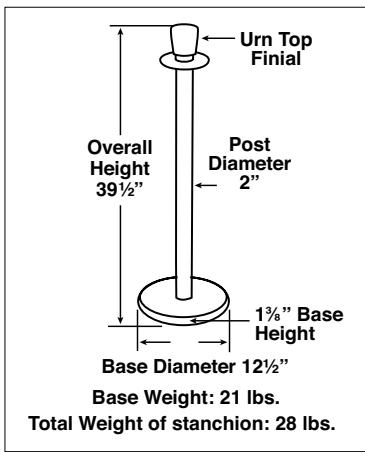
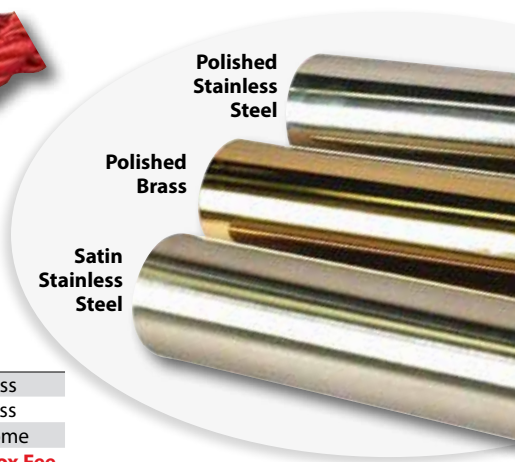

WALL PLATE

- 1-5/8" Square with 2 Countersunk Holes
- Over Height: 1.40"
- Thickness: 1/4"



Part #	Finish
CLS-WP-BR	Polished Brass
CLS-WP-CH	Polished Chrome

Screws with Anchors Included

CRUSHED VELOUR



ROPES

SNAP HOOK FINISH

- Polished Chrome (CH)
- Polished Brass (BR)

Premium Ropes With Weighted Chain

Part #	Style	Length
CLS-RP4-	Velour	4 ft.
CLS-RP6-	Velour	6 ft.

Economy Ropes

Part #	Style	Length
CLS-RP6E-	Velour	6 ft.

^ Available in Black, Blue & Burgundy

BRAIDED



Part #	Style	Length
CLS-BRD4-	Braided	4 ft.
CLS-BRD6-	Braided	6 ft.

- Rope Dia.: 1-1/8"
- Metal Connector Diameter: 1-1/4"

NOTE: Please add appropriate color code & finish code to part # when ordering.
(Example: CLS-RP4-BRG-BR = 4 ft. Velvet Rope, Burgundy with Brass Hooks)

RETRACT-IT II

Black Powder Coated or Chrome Plated Stanchions with Polyester Retractable Belt

IN STOCK TODAY!!!

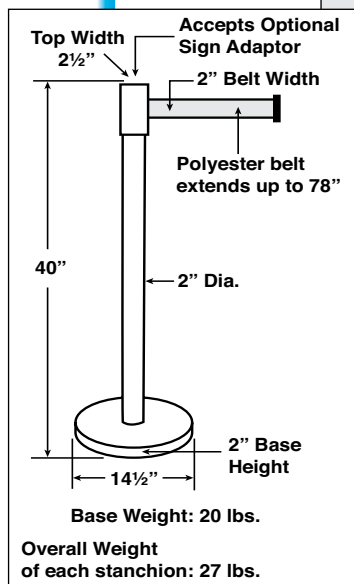
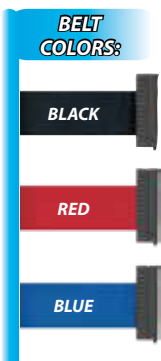

★ PRODUCT FEATURES:



★ NON-MARRING RUBBERIZED FLOOR RING WITH A CORROSION RESISTANT GALVANIZED STEEL BASE

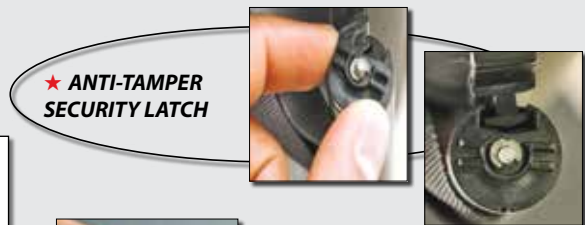

★ ANTI-TAMPER SECURITY LATCH



★ BUILT-IN 4-WAY ADAPTOR EXPANDS YOUR CONFIGURATION POSSIBILITIES

BONUS FEATURE
★ WORKS WITH ALL MAJOR BRANDS OF STANCHIONS, ADD ON & SAVE!

★ SHIPS KNOCK DOWN IN A UPS SIZE CARTON!

Part#	Post Finish	Belt Color
RCT2-BLK-BLK	Black Powder Coated	Black
RCT2-BLK-RED	Black Powder Coated	Red
RCT2-BLK-BLU	Black Powder Coated	Blue
RCT2-CHR-BLK	Polished Chrome	Black
RCT2-CHR-RED	Polished Chrome	Red

PACKED 2 PER CARTON - BROKEN BOX FEE (#BB10)

WALL MOUNT BELT

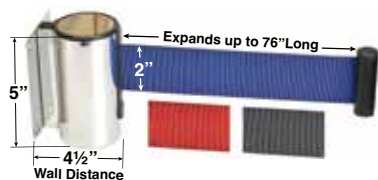

RCT2-WALL-*

SET DOES NOT INCLUDE RCT2-PLATE

***(Red, Black & Blue)**

WALL MOUNT PLATE

To be used w/stanchions



RCT2-PLATE

2-SIDED SIGN HOLDER

WORKS WITH RETRACT-IT II

Holds 8.5" x 11" sign with no-glare plastic protective plastic sheet



RCT2-SIGN

POP BOWL

WORKS WITH RETRACT-IT II

Acrylic display bowl with aluminum axle and pul cap

Width: 13-3/8" Height: 5-5/16"



RCT2-BOWL-2

Perfect for impulse buy items



Wood Stanchions



WS-223-BR
shown

- Furniture Grade Quality
- Solid Red Oak with English Oak Stain
- Durable commercial grade finish
- Handcarved
- Pre-finished & sealed with a hand rubbed teak oil.
- Works with all standard ropes
- Exquisite Craftsmanship
- 72 Combinations
- Ships UPS
- Ropes attach at a 36 inch height



Ropes



See page D-25 for more information on ropes

Crushed
Velour

Braided



SQUARE EGG AND DART BASE

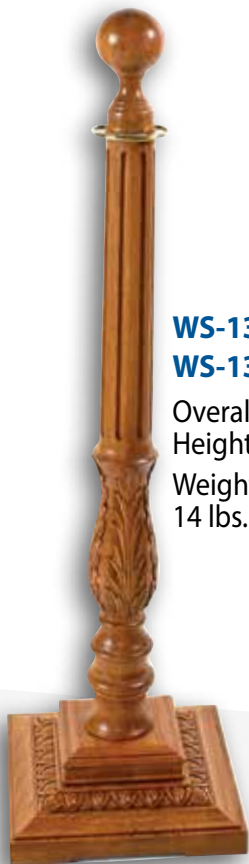

WS-133-BR
WS-133-BC

Overall
Height: 41"
Weight:
14 lbs.

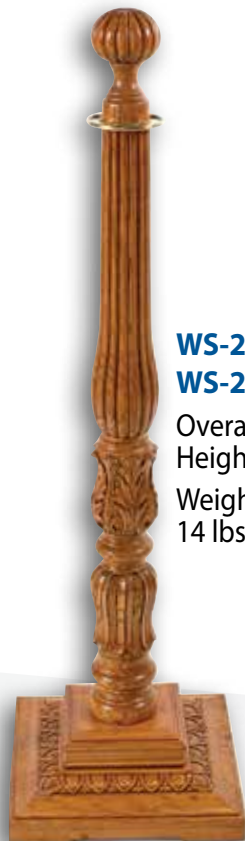

WS-223-BR
WS-223-BC

Overall
Height: 41"
Weight:
14 lbs.

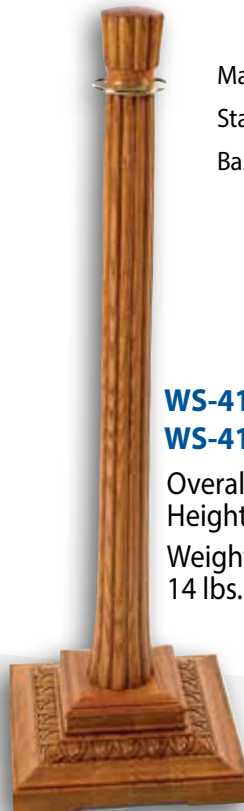

WS-413-BR
WS-413-BC

Overall
Height: 39"
Weight:
14 lbs.

Material: Solid Red Oak
Stain: Medium English Oak
Base: 12" Square

PLAIN ROUND BASE



WS-132-BR
WS-132-BC

Overall
Height: 41"
Weight:
15 lbs.



WS-222-BR
WS-222-BC

Overall
Height: 41"
Weight:
15 lbs.

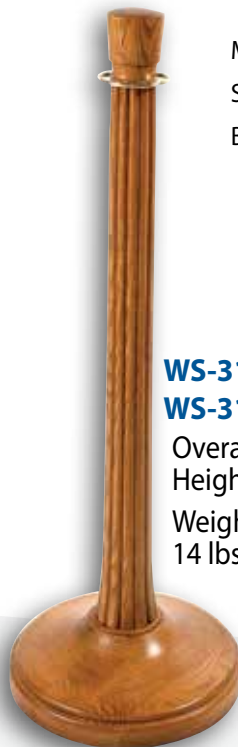

WS-312-BR
WS-312-BC

Overall
Height: 39"
Weight:
14 lbs.

Material: Solid Red Oak
Stain: Medium English Oak
Base: 13-3/4" Diameter

ROUND ACANTHUS LEAF BASE

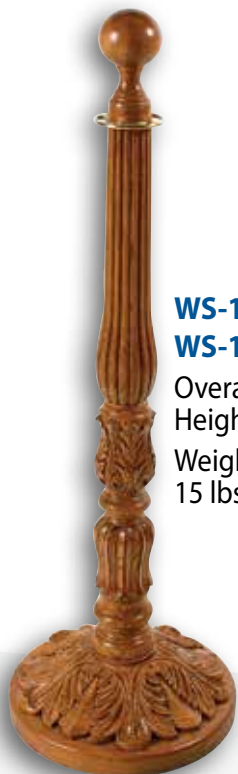

WS-121-BR
WS-121-BC

Overall
Height: 41"
Weight:
15 lbs.



WS-211-BR
WS-211-BC

Overall
Height: 41"
Weight:
14 lbs.



WS-331-BR
WS-331-BC

Overall
Height: 39"
Weight:
15 lbs.

Material: Solid Red Oak
Stain: Medium English Oak
Base: 13-3/4" Diameter

PLASTIC STANCHIONS WITH BASE

“Crowd Control In A Box”

VALUE 4 PACK



Part #	Color
SNB-40BK-KIT	Black
SNB-40WH-KIT	White

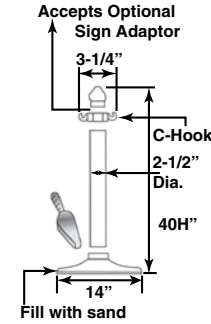

Plastic chain easily connects to C-hook assembly.



Remove cap to slip chain through or to connect the optional signage adaptor.

See bottom for optional sign adaptor

Part #	Description	Color
SNB-40PC-KIT	4 Stanchions & 32 ft. of chain	Polished Chrome
SNB-40PC-KITNC	4 Stanchions without chain	Polished Chrome

PLASTIC STANCHIONS WITH BASE

Great For Most Control Needs!

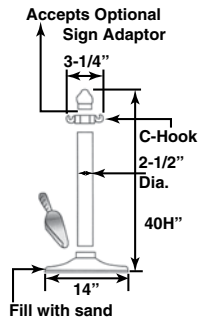

- Recommended maximum distance should not exceed 8' between stanchions
- For added support, it is recommended that the base be filled with sand
- One C-hook assembly included with each stanchion
(C-Hook NOT removable on SNB-40PC)

Part #	Color	Description
SNB-40BK	Black	40"H x 2-1/2 Dia.
SNB-40WH	White	40"H x 2-1/2 Dia.
SNB-40PC	Polished Chrome	40"H x 3" Dia.

Other colors available - please inquire

PLASTIC LANDSCAPE STANCHIONS WITH STAKE

Great For Outdoor Events, Landscapes & Gardens!

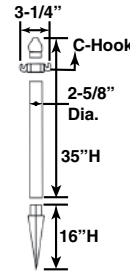

- Recommended maximum distance should not exceed 8' between stanchions.
- One C-hook assembly included with each stanchion

Part #	Color	Description
SNS-40BK	Black	35"H x 2-5/8"
SNS-40WH	White	35"H x 2-5/8"

Other colors available - please inquire

PLASTIC CHAINS



Available Colors

- All colors stocked in 33 ft. lengths (Polished Chrome stocked in 16 ft. lengths).
- Available in 3/4", 1", 1-1/2" and 2" links.
- Color chains must be purchased in full 33' lengths. (Polished Chrome must be purchased in 16 ft. lengths).
- All plastic chains come bagged except for 2" chain which comes on a reel.

*Color Code:

- BL (Blue)
- RD (Red)
- PK (Pink)
- GR (Green)
- OR (Orange)
- WH (White)
- BK (Black)
- PC (Polished Chrome)
- YE (Yellow)

Part #	Size
PC24-*	3/4"
PC32-*	1"
PC48-*	1-1/2"
PC64-*	2"

POLISHED CHROME ONLY

Part #	Size
PC32-PC	1"
PC48-PC	1-1/2"

Other colors available - please inquire

PLASTIC S-HOOKS

Colors available: White, Polished Chrome or Black

BLACK & WHITE
(Color Code* BK: Black, WH: White)

Part #	Size
SH32-*	1"
SH48-*	1-1/2"
SH64-*	2"

POLISHED CHROME

Part #	Size
SH32-PC	1"
SH48-PC	1-1/2"
SH64-PC	2"



PLASTIC CONNECTING LINKS

Colors available: White, Polished Chrome or Black

BLACK & WHITE
(Color Code* BK: Black, WH: White)

Part #	Size
CL48-*	1-1/2"
CL64-*	2"

POLISHED CHROME

Part #	Size
CL48-PC	1-1/2"
CL64-PC	2"



SPRING LOADED NYLON RETRACTABLE CONNECTING LINK



Colors available: Black or White

Part #	Color
SNAP-BK	Black
SNAP-WH	White

PLASTIC CLOTHES PIN



Colors available: Ivory
• Clothes pin attaches to plastic chain.

Part #	Color
PC-HANGPIN	Ivory