

## 14 Series

**Material:** Steel

**Finishes:** High Gloss Black, Polished Chrome & Matte Nickel

- 28" High
- Height Adjustment: 1-1/4"
- Each set comes with 4 legs & 4 steel mounting plates (Unassembled).
- The thickness of the table top must be at least 1"
- Use #10 Panhead wood screws
- Leveler: Black ABS

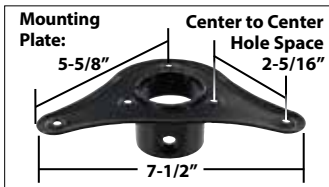

Part #	Finish
<b>14MB</b>	High Gloss Black
<b>14PC</b>	Polished Chrome
<b>14MN</b>	Matte Nickel

## TLC8 Series

**Material:** Steel

**Finishes:** Black, Chrome & Matte Nickel

- 28" High
- Height adjustment: + 1-7/16"
- Each set comes with 4 legs & 4 steel mounting plates (Unassembled).
- The thickness of the table top must be at least 1".
- Use #10 Panhead wood screws
- Leveler: Black ABS

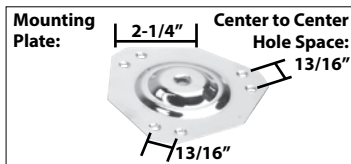

Part #	Finish
<b>TLC8-2002-BK</b>	Black
<b>TLC8-2002-CHR</b>	Chrome
<b>TLC8-2002-MN</b>	Matte Nickel

## TL4 & TL6 Series

**Material:** Steel

**Finishes:** Black, Chrome & Matte Nickel

- Available in 2 heights: 6" & 16"
- Height adjustment: + 1-7/16"
- Each set comes with 4 legs & 4 steel mounting plates (Unassembled).
- The thickness of the table top must be at least 1"
- Use #10 Panhead wood screws
- Leveler: Black ABS

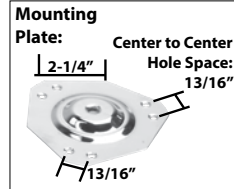

### TL4 Series - 6"



Part #	Finish
<b>TL4-2002-BK</b>	Black
<b>TL4-2002-CHR</b>	Chrome
<b>TL4-2002-MN</b>	Matte Nickel

### TL6 Series - 16"



Part #	Finish
<b>TL6-2002-BK</b>	Black
<b>TL6-2002-CHR</b>	Chrome
<b>TL6-2002-MN</b>	Matte Nickel

## Wire Management for Round Table Legs



**Material:** Black PVC

**5 Ft. lengths with Adhesive Back**

**Fits 2-3/8" Table Leg**

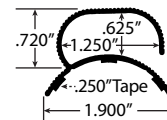

Part #
<b>CWM-1575-BK</b>

## Folding Table Legs - 2" Diameter

**Material:** Steel & Aluminum

- 27-3/4" high x 2" diameter
- Single button release foldable leg
- 220 lb. capacity per leg
- Sold in sets of 4
- Supplied with levelers  
- adjustable to 1-1/8"

Weight: 8 lbs. per set

Top Plate: 5-1/8" x 3-5/8"

Thickness: 1/4"

8 Countersunk holes

Leveler: Black ABS

Mounting hardware included



Part #	Finish
<b>FTL-AL</b>	Ribbed Aluminum
<b>FTL-MB</b>	Matte Black
<b>FTL-PC</b>	Polished Chrome

**Finishes:**



## Cast Aluminum Furniture Legs with Rubber Foot Bumpers

**Finishes:** Satin Chrome (SC), Brite Chrome (CHR)

### WGL-220-CHR

Overall Height: 15-1/4"

Weight: 2.25 lbs. ea.

Top Plate: 3-1/16" sq.

Thickness: 1/4"

3 Countersunk holes

Base of Foot:

1-1/2" dia.

Foot has a black rubber bumper



### WGL-330-SC

Overall Height: 27-1/4"

Weight: 3.95 lbs. ea.

Top Plate: 3-1/2" x 4-1/2"

Thickness: 1/2"

5 Countersunk holes

Base of Foot:

1-1/8" x 7/8" x 7/8"

Foot has a black rubber bumper



### WGL-260-SC

Overall Height: 29-1/2"

Weight: 4.70 lbs. ea.

Top Plate: 3-3/4" sq.

Thickness: 1/2"

4 Countersunk holes

Base of Foot:

13/16" x 3/8"

Foot has a black rubber bumper



### X-Style Cast Iron Table Bases

**Material:** Cast Iron & Steel  
**Finish:** Matte Black Wrinkle

- Available in two heights:  
 28" for table height **\*(-T)**  
 40" for bar height **\*(-B)**
- Column: 3" diameter steel
- Plate: 9" x 9" spider style
- Packed 1 base per carton
- TB-X522.\*  
 single leg only  
 as pictured



Part #	Leg Spread	Max Top Size
<b>+ TB-X522.*</b>	5" x 22"	<b>+ 36" x 96"</b>
<b>TB-X2230.*</b>	22" x 30"	30" x 42"
<b>TB-X2222.*</b>	22" x 22"	30" x 30"
<b>TB-X3030.*</b>	30" x 30"	42" x 42"

+ *Note: Table top size reflects mounting with 3 bases or with one side mounted to the wall*

### Round Cast Iron Table Bases

**Material:** Cast Iron & Steel  
**Finish:** Matte Black Wrinkle

- Available in two heights:  
 29" for table height **\*(-T)**  
 41" for bar height **\*(-B)**
- Column: 3" diameter steel
- Plate: 9" x 9" spider style
- Packed 1 base per carton
- Bar height available with foot ring option



Part #	Base Diameter	Max Top Size	Foot Ring
<b>TB-RD22.*</b>	22"	36" x 36"	No
<b>TB-RDF22.*</b>	22"	36" x 36"	Yes

### Stainless Steel Round Table Bases

**Material:** Steel & Stainless Steel  
**Finish:** Brushed Stainless Steel

- Available in two heights:  
 28-3/8" for table height **\*(-T)**  
 42-1/2" for bar height **\*(-B)**
- Column: 3" diameter steel
- Plate: 12" x 12" spider style
- Packed 1 base per carton



Part #	Base Diameter	Max Top Size
<b>TB-B17-SS.*</b>	17"	24" x 24"
<b>TB-B22-SS.*</b>	22"	36" x 36"

### Stainless Steel Square Table Bases

**Material:** Steel & Stainless Steel  
**Finish:** Brushed Stainless Steel

- Available in two heights:  
 28-3/8" for table height **\*(-T)**  
 42-1/2" for bar height **\*(-B)**
- Column: 3" diameter steel
- Plate: 12" x 12" spider style
- Packed 1 base per carton



Part #	Base Size	Max Top Size
<b>TB-SQ17-SS.*</b>	17" x 17"	24" x 24"
<b>TB-SQ22-SS.*</b>	22" x 22"	36" x 36"

# Metal Legs with Threaded Stems

**Finishes:** Brite Chrome (CHR), Satin Chrome (SC), Pewter (PEW), Brushed Silver (SIL)

## WGL-3019-CHR

Material: Zinc  
Overall Height: 7"  
Weight: 1.6 lbs. ea.  
Top measures: 3" dia.  
5/16" x 1" Threaded Stem  
Base of Foot: 1" dia.  
Foot has a black plastic bumper



## WGL-3112-SIL

Material: Aluminum  
Overall Height: 5-1/2"  
Weight: 0.6 lbs. ea.  
Top measures: 1-1/2" dia.  
5/16" x 1" Threaded Stem  
Base of Foot: 1-7/16" dia.  
Foot has a black plastic bumper



## WGL-938-CHR WGL-938-PEW

Material: Zinc  
Overall Height: 5-1/4"  
Weight: 0.6 lbs. ea.  
Top measures: 1-1/2" dia.  
5/16" x 1" Threaded Stem  
Base of Foot: 2-1/8" dia.  
Foot has a black plastic bumper



## WGL-8244-SC

Material: Aluminum  
Overall Height: 6"  
Weight: 0.9 lbs. ea.  
Top measures: 1-3/8" dia.  
5/16" x 1" Threaded Stem  
Base of Foot: 1-3/8" dia.  
Foot has a black plastic bumper



## WGL-988CHR

Material: Stainless Steel  
Overall Height: 4"  
Weight: 1.27 lbs. ea.  
Top measures: 1-3/4" dia.  
5/16" x 1" Threaded Stem  
Base of Foot: 1-5/8" dia.  
Foot has a white felt pad



# Metal Sofa Legs w/Plate

**Finish:** Brite Chrome (CHR)

## WGL-376-CHR

Material: Zinc  
Overall Height: 2"  
Weight: 1.2 lbs. ea.  
Top measures: 6" x 6" x 8-1/4"  
1 Countersunk hole @ 11/32" dia.  
Foot has a 3 black plastic bumpers



# Metal Furniture Legs with Plate

**Finishes:** Brite Chrome (CHR), Satin Chrome (SAT), Matte Nickel (MN)

## WGL-919A-MN

Material: Zinc  
Overall Height: 3-5/8"  
Weight: 0.67 lbs. ea.  
Top measures: 1-3/4" x 2-3/4"  
Thickness: 3/32"  
3 Screw holes & 1 bolt hole  
Base of Foot: 1-7/8" dia.  
Foot has a clear rubber bumper



## WGL-8343-CHR

Material: Zinc  
Overall Height: 3-3/4"  
Weight: 0.6 lbs. ea.  
Top measures: 3-3/16" x 1-7/8"  
Thickness: 9/32"  
4 Countersunk holes  
Base of Foot: 1-1/4" x 1-3/16"  
Foot has a black plastic bumper



## WGL-634CHR

Material: Zinc  
Overall Height: 4"  
Weight: 0.4 lbs. ea.  
Top measures: 3-3/16" x 2-3/16"  
Thickness: 9/64"  
4 Screw holes  
Base of Foot: 2-1/16" dia.  
Foot has a clear rubber bumper



## WGL-814CHR

Material: Zinc  
Overall Height: 4"  
Weight: 0.6 lbs. ea.  
Top measures: 3" x 2-3/4"  
Thickness: 9/64"  
4 Screw holes  
Base of Foot: 1" x 1-1/8"  
Foot has a black plastic bumper



## WGL-8110-SAT

Material: Aluminum  
Overall Height: 4"  
Weight: 0.6 lbs. ea.  
Top measures: 3-1/8" sq.  
Thickness: 5/16"  
5 Countersunk holes  
Base of Foot: 1-1/2" sq.  
Foot has a black plastic bumper



# Metal Furniture Legs with Plate

**Finishes:** Satin Chrome (SC), Brite Chrome (CHR), Satin Nickel (SN), Brushed Stainless Steel (SS), Silver (SIL), Mated Brass (MB)

## WGL-804A-CHR

Material: Zinc  
 Overall Height: 5"  
 Weight: 0.8 lbs. ea.  
 Top Plate: 2-5/8" x 3-1/2"  
 Thickness: 11/64"  
 4 Screw holes  
 Base of Foot: 2-3/8" dia.  
 Foot has a clear rubber bumper



## WGL-635SC

Material: Zinc  
 Overall Height: 5"  
 Weight: 1.2 lbs. ea.  
 Top Plate: 3-7/8" x 3"  
 Thickness: 11/64"  
 3 Screw holes  
 Base of Foot: 2-1/2" dia.  
 Foot has a black rubber bumper



## WGL-640CHR

Material: Zinc  
 Overall Height: 5"  
 Weight: 0.6 lbs. ea.  
 Top Plate: 2-3/8" x 2-5/8"  
 Thickness: 9/64"  
 5 Screw holes  
 Base of Foot: 2-1/8" dia.  
 Foot has a clear rubber bumper



## WGL-8113-CHR

Material: Stainless Steel  
 Overall Height: 5"  
 Weight: 0.75 lbs. ea.  
 Top Plate:  
 4-7/8" x 4-7/8" x 5-5/8"  
 Thickness: 5/64"  
 3 Countersunk holes  
 Leg measures 1" sq.  
 Foot has a gray plastic bumper



## WGL-8112-CHR

Material: Stainless Steel  
 Overall Height: 6"  
 Weight: 1.0 lbs. ea.  
 Top Plate:  
 3-5/16" x 3-5/16" x 4-5/8"  
 Thickness: 1/4"  
 5 Countersunk holes  
 Leg measures 1-1/2" sq.  
 Foot has a black plastic bumper



## WGL-8112-SN

Material: Stainless Steel  
 Overall Height: 6-3/16"  
 Weight: 0.625 lbs. ea.  
 Top Plate:  
 3-9/16" x 3-9/16" x 5"  
 Thickness: 3/32"  
 4 Countersunk holes  
 Leg measures 1-1/2" sq.  
 Foot has a black plastic bumper



## WGL-8111-SS

Material: Stainless Steel  
 Overall Height: 6-1/8"  
 Weight: 0.56 lbs. ea.  
 Top Plate: 3-1/4" x 1-1/2"  
 Thickness: 1/8"  
 4 Countersunk holes  
 Leg measures 1-1/2" sq.  
 Foot has a black plastic bumper



## WGL-1009-MB

Material: Iron  
 Overall Height: 6"  
 Weight: 1.0 lbs. ea.  
 Top Plate:  
 5-1/8" x 5-1/8" x 1-1/2"  
 Thickness: 1/8"  
 4 Screw holes  
 Leg measures 5-1/8" at the top and narrows down to 3/4"  
 Foot has a clear rubber bumper

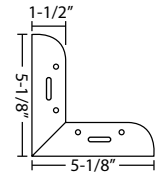
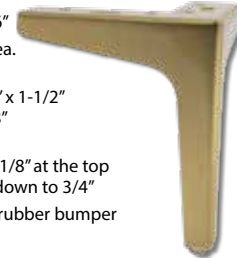

## Plastic Legs

### Recycled Polypropylene

**Finish:** Brown  
 Thread Size 5/16-18 x 1" Stem

#### R70-300

3" High x 2" Round  
 Tapers to 1-3/4"



### High Density Polyethylene

**Finish:** Brown  
 Thread Size 5/16-18 x 1" Stem

#### R70-400

4" High x 2" Round  
 Tapers to 1-1/2"



# Cast Aluminum Furniture Legs with Rubber Foot Bumpers

**Finishes:** Satin Chrome (SC), Brite Chrome (CHR)



**WGL-124-SC**  
**WGL-125-CHR**

Overall Height: 4-1/2"  
Weight: 0.35 lbs. ea.  
Top Plate:  
2-1/4" x 2-1/4" x 3"  
Thickness: 7/32"  
3 Countersunk holes  
Foot has a black  
rubber bumper



**WGL-280-SC**

Overall Height: 4"  
Weight: 0.45 lbs. ea.  
Top Plate:  
2-3/4" x 2-3/4" x 4"  
Thickness: 15/64"  
3 Countersunk holes  
Base of Foot:  
1" x 1" x 1-3/8"  
Foot has a black rubber bumper



**WGL-020-SC**  
**WGL-010-CHR**

Overall Height: 4"  
Weight: 0.65 lbs. ea.  
Top Plate: 2-15/16" sq.  
Thickness: 1/4"  
4 Countersunk holes  
Foot has a black  
rubber bumper



**WGL-060-SC**  
**WGL-050-CHR**

Overall Height: 4"  
Weight: 0.75 lbs. ea.  
Top Plate: 2" sq.  
Thickness: 11/32"  
3 Countersunk holes  
Base of Foot: 1-1/8"  
Foot has a black rubber bumper



**WGL-040-SC**  
**WGL-030-CHR**

Overall Height: 5-1/4"  
Weight: 0.85 lbs. ea.  
Top Plate: 2-5/8" sq.  
Thickness: 3/8"  
3 Countersunk holes  
Base of Foot:  
1-3/4"  
Foot has a black rubber bumper



**WGL-150-CHR**

Overall Height: 5-1/2"  
Weight: 1.10 lbs. ea.  
Top Plate: 3-1/8" sq.  
Thickness: 1/4"  
4 Countersunk holes  
Base of Foot:  
1-5/8" sq.  
Foot has a black  
rubber bumper



**WGL-070-SC**

Overall Height: 7-1/4"  
Weight: 0.90 lbs. ea.  
Top Plate: 2-3/8" sq.  
Thickness: 3/8"  
3 Countersunk holes  
Foot has a black  
rubber bumper



**WGL-110-SC**  
**WGL-120-CHR**

Overall Height: 8"  
Weight: 0.75 lbs. ea.  
Top Plate:  
2-3/4" x 2-3/4" x 4"  
Thickness: 11/32"  
3 Countersunk holes  
Base of Foot:  
3/8" x 3/8" x 3/8"  
Foot has a black  
rubber bumper



**SEE PAGES L-93~97 FOR KITCHEN ISLAND LEGS**

**OUTWATER INDUSTRIES, INC. • www.outwater.com**



NSF CERTIFICATE NUMBERS AND MANUFACTURER NAME AVAILABLE UPON REQUEST.

## 4" Heavy Duty Appliance Legs

- Hi-temp, impact resistant thermoplastic body
- Strong, die-cast flanged foot is nickel plated
- Height adjusts 1-1/4"
- 3/8" - 16 Heavy duty steel mounting stud
- Static load rating: 2000 lbs. per leg

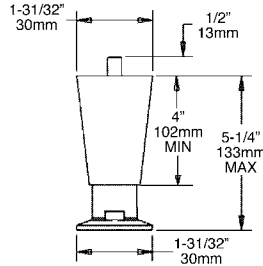

Part #	Finish	Threaded Stem
<b>HDW-1902-BK</b>	Black	3/8-16 Stud
<b>HDW-1902-NP</b>	Nickel Plated	3/8-16 Stud

## Stainless Steel Clad Leg w/Adjustable Foot

- Stainless Steel Clad with strong engineered plastic internal construction
- Round Foot with non-marking plastic glide
- 2" overall diameter
- Static load rating: 2000 lbs per leg

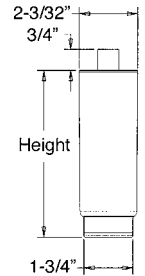

Part #	Height	Foot Adjusts	Threaded Stem
<b>HDW-1907-4</b>	4"	up to 1-3/4"	3/8-16 Stud
<b>HDW-1908-4</b>	6"	up to 2"	1/2-13 Stud

## Tubular Leg Assembly w/Mounting Plate



- Stainless steel
- 1-5/8" diameter
- 3-1/2" square removable mounting plate
- Static load rating: 2000 lbs. per leg

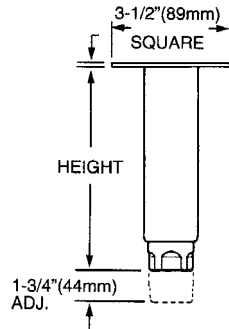

Part #	Height
<b>HDW-1901</b>	6"
<b>HDW-1901-4</b>	4"

## Tubular Leg Assembly



- Stainless steel
- 1-5/8" diameter
- 1/2-13 x 3/4" stud
- Static load rating: 2000 lbs. per leg

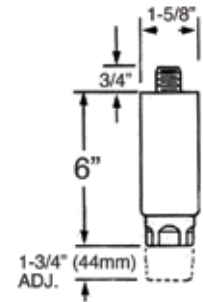

Part #	Height
<b>HDW-1903</b>	6"

## Econoline Leg



- Nickel plated hex foot
- 3-1/2" square removable mounting plate
- Static load rating: 2000 lbs. per leg

ALL MODELS HAVE A STATIC LOAD RATING OF 2000 LBS. (900Kg) PER LEG  
MTG PLATE HAS (4) 5/16" (8mm) DIA. HOLES ON 2-5/8" (66mm) CENTERS.

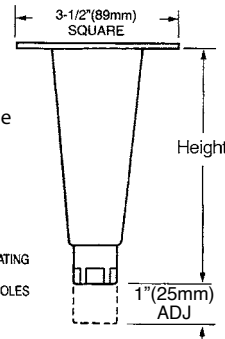

Part #	Height
<b>HDW-1900</b>	6"
<b>HDW-1900-4</b>	4"

# Wood Furniture Legs

- Available in Unfinished Hardwood, Cherry & Espresso
- 5/16-18 x 1" Long Thread



## Round Bun Feet

**BUN32-UN** ●  
**BUN32-CH**  
**BUN32-ESPR**

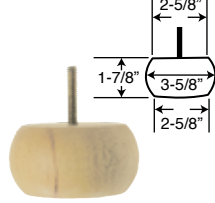

**BUN01-UN** ●

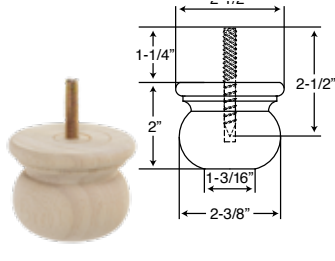

**BUN02-UN** ●

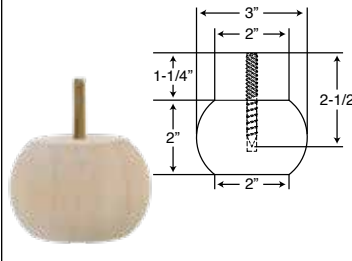

**BUN31-UN**

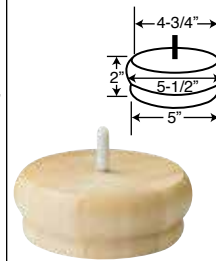

**BUN40-2-UN**  
**BUN40-2-CH**  
**BUN40-2-ESPR**

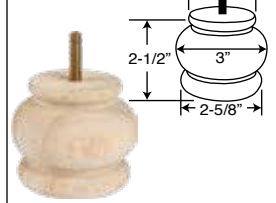

**BUN83-UN**  
**BUN83-CH** ●  
**BUN83-ESPR**

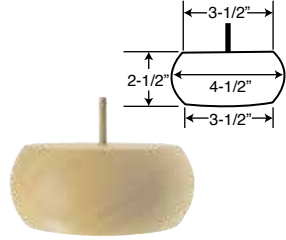

**BUN41-UN**

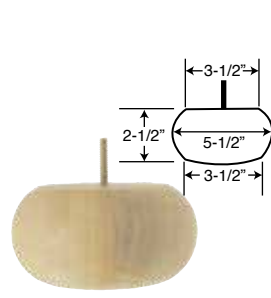

**BUN03-UN** ●  
**BUN03-CH**  
**BUN03-ESPR**

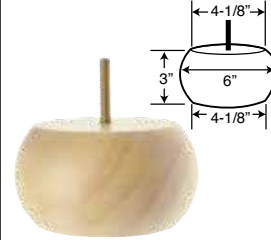

**BUN89-UN**

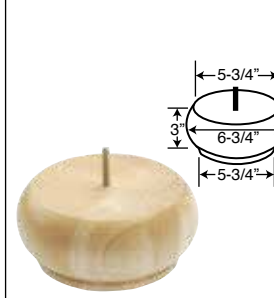

**BUN24-UN**  
**BUN24-CH**  
**BUN24-ESPR**

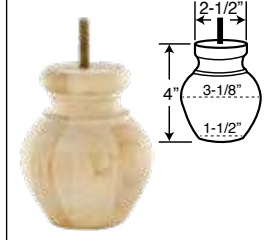

**BUN23-UN**

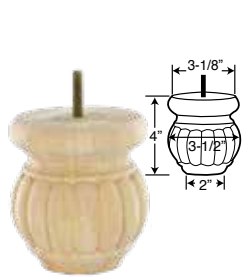

**BUN39-UN**

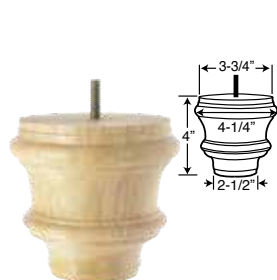

**BUN44-UN**

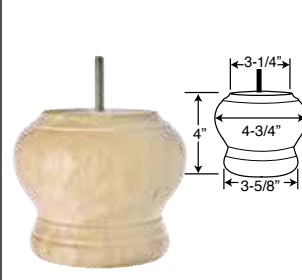

**BUN26-UN**

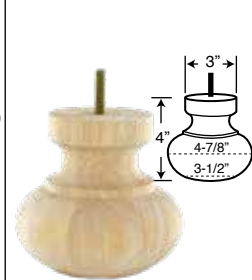

**BUN40-UN**  
**BUN40-CH** ●  
**BUN40-ESPR** ●

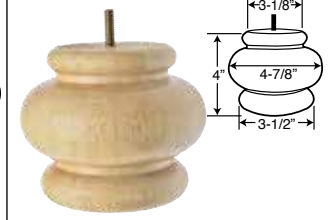

**BUN25-UN**  
**BUN25-CH**  
**BUN25-ESPR**

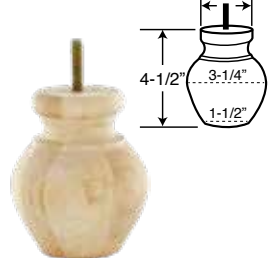

**BUN27-UN**

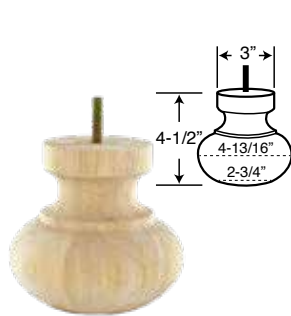

**BUN06-5-UN** ●  
**BUN06-5-CH** ●  
**BUN06-5-ESPR**

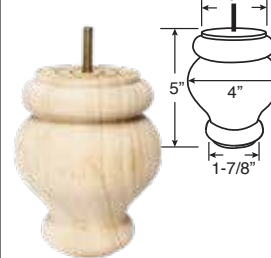

**BUN25-5-UN**  
**BUN25-5-CH**  
**BUN25-5-ESPR**

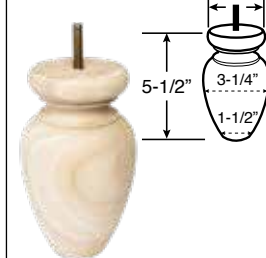

**BUN06-UN**  
**BUN06-CH**  
**BUN06-ESPR** ●

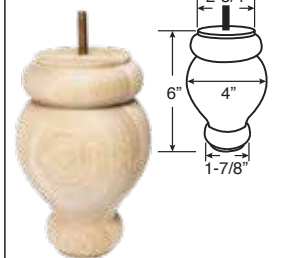

● Comes with a Soft Non-Skid Protective Pad



Square Bun Feet

<p><b>BUN09-UN</b></p>	<p><b>BUN34-2-UN</b> ●  <b>BUN34-2-CH</b>  <b>BUN34-2-ESPR</b>  <i>Includes glide/screws</i></p>	<p><b>BUN34-UN</b>  <b>BUN34-CH</b> ●  <b>BUN34-ESPR</b> ●  <i>Includes glide/screws</i></p>	<p><b>BUN57-UN</b></p>
<p><b>BUN103-UN</b></p>	<p><b>BUN47-UN</b></p>	<p><b>BUN48-UN</b></p>	<p><b>BUN49-UN</b>  <b>BUN49-CH</b> ●  <b>BUN49-ESPR</b> ●</p>
<p><b>BUN50-UN</b>  <b>BUN50-CH</b>  <b>BUN50-ESPR</b></p>	<p><b>BUN50-6-UN</b>  <b>BUN50-6-CH</b>  <b>BUN50-6-ESPR</b> ●</p>	<p><b>Queen Ann</b></p> <p><b>BUN51-UN</b></p> <p><b>BUN38-UN</b></p>	

Sofa Legs

<p><b>BUN121-UN</b></p>	<p><b>BUN330-UN</b></p>	<p><b>BUN88-UN</b> ●</p>	
<p><b>BUN14-4-UN</b>  <b>BUN14-4-CH</b>  <b>BUN14-4-ESPR</b></p>	<p><b>BUN14-UN</b>  <b>BUN14-CH</b>  <b>BUN14-ESPR</b></p>	<p><b>BUN14-6-UN</b>  <b>BUN14-6-CH</b>  <b>BUN14-6-ESPR</b></p>	

● Comes with a Soft Non-Skid Protective Pad, see E-11

**WFL20-4-UN**  
**WFL20-4-ESPR**

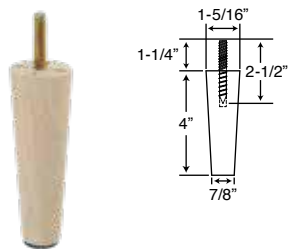

**WFL08-5-UN**

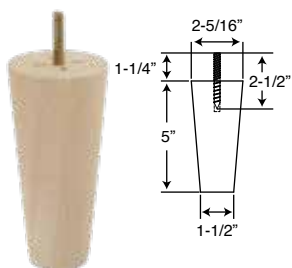

**WFL23-6-UN**  
**WFL23-6-ESPR**

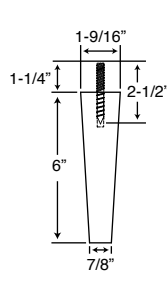

**WFL11-6-UN**

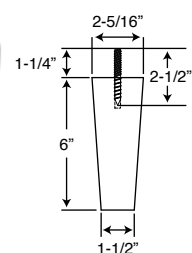

**WFL14-6-UN**  
**WFL14-6-ESPR**

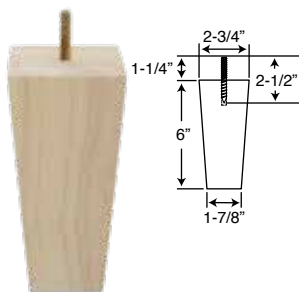

**WFL26-8-UN**  
**WFL26-8-ESPR**

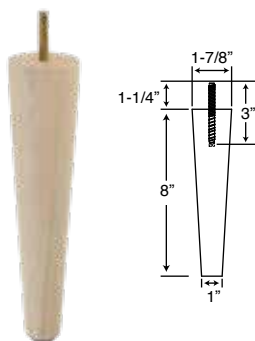

**WFL17-8-UN**  
**WFL17-8-ESPR**

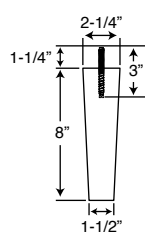

**WFL05-8-UN**  
**WFL05-8-ESPR**

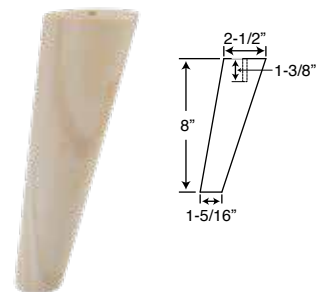

**WFL29-10-UN**  
**WFL29-10-ESPR**

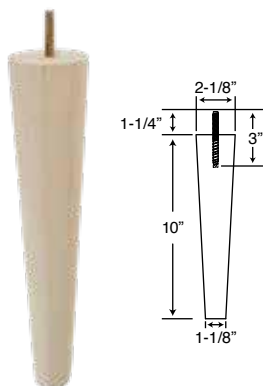

**WFL32-12-UN**  
**WFL32-12-ESPR**

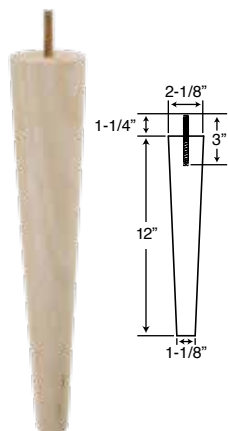

**WFL01-16-UN**  
**WFL01-16-ESPR**

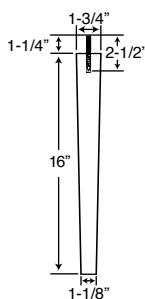

**ALL WOOD FURNITURE LEGS  
ON THIS PAGE  
COME WITH  
SOFT NON-SKID  
PROTECTIVE PADS**



# Adjustable Cabinet Legs

## Metal Leg Sets

### Groove Mount



### Screw Mount



- Adjustable from 4" to 6-1/2"
- Comes poly bagged in sets of 4 metal leg levelers, 4 metal sockets, 4 hollow bolts, 2 toe kick clips (screw mount or groove mount), 4 white & 4 almond cover caps
- 330 lb. weight capacity per leg

Part #	Toe Kick Clamp Style
<b>CLG-425G</b>	Groove Mount
<b>CLG-426S</b>	Screw Mount

## ABS Plastic Leg Set



- Comes packed in sets of 4 black legs, 4 top sockets & 2 black toe clips

Part #	Height Adjustment	Material	Load Capacity Per Leg	Toe Kick Clamp Style
<b>OPHS-2609</b>	3.68"-6.28"	Polystyrene	450 lbs.	Screw

## A La Carte Cabinet Legs & Accessories

### Cabinet Leg



**Material: ABS Plastic**

- Two piece white leveling leg (foot & shaft)
- 330 lb. load capacity per leg

Part #	Height Adjustment
<b>CLG-423-6</b>	6" - 6-5/8"

### Top Sockets

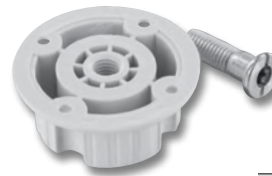

**Material: ABS Plastic**

- White
- Bolt included

Part #
<b>CLG-841</b>

### Toe Kick Clip



**Material: Steel Metal Clip, Black ABS Backing Plate**

- Screw mount 4-finger clip

Part #
<b>CLG-202-T2</b>

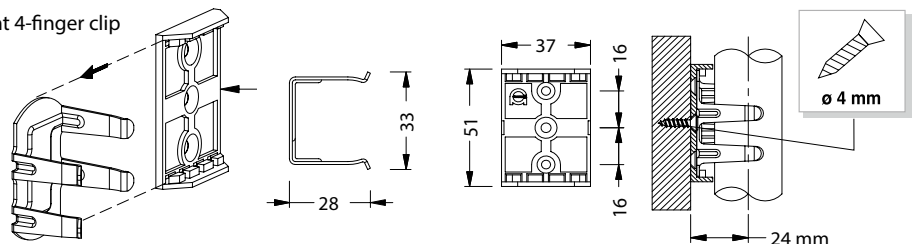

# Nylon Locking Hole Plugs



- Designed with multiple locks to snap in panel thicknesses from 1/64"-1/8"
- Used to close excess chassis holes, wiring outlets & production access holes
- Suitable for critical or elevated temperature application
- Can also be used for wood panel
- Heat stabilized nylon (UL94V2)
- ABS flammability rating (94-HB)

## CLEAR

Part #	Chassis Dimensions		Part Dimensions	
	Hole Dia.	Maximum Thickness	A Head Dia.	B Thickness
MP-1000CL	1"	1/8"	1.125	.453

**BLACK OR WHITE** All available in Black, or add a "W" for White.

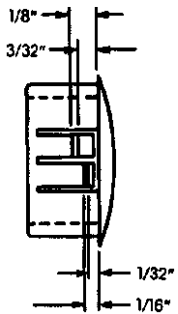
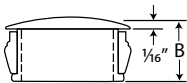
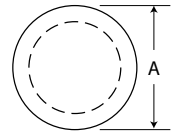

Part #	Chassis Dimensions		Part Dimensions	
	Hole Dia.	Maximum Thickness	A Head Dia.	B Thickness
MP-0187	3/16"	1/16"	.250	.234
MP-0250	1/4"	1/16"	.312	.312
MP-0312	5/16"	1/16"	.375	.312
MP-0375	3/8"	1/8"	.468	.406
MP-0437	7/16"	1/8"	.531	.406
MP-0500	1/2"	1/8"	.578	.406
MP-0562	9/16"	1/8"	.656	.406
MP-0625	5/8"	1/8"	.718	.406
MP-0750	3/4"	1/8"	.922	.406
MP-0875	7/8"	1/8"	1.016	.453
MP-1000	1"	1/8"	1.203	.453
MP-1093	1-3/32" - 1-7/32"	1/8"	1.218	.453
MP-1187	1-3/16"	1/8"	1.312	.453
MP-1250	1-1/4"	1/8"	1.375	.453
MP-1375	1-3/8"	1/8"	1.500	.453
MP-1500	1-1/2"	1/8"	1.672	.453
MP-1750	1-3/4"	1/8"	1.906	.453
MP-2000	2"	1/8"	2.140	.453

## LOCKING VENTED HOLE PLUGS



All available in Black, or add a "W" for White.



Part #	Hole Dia.	Maximum Thickness	A Head Dia.	B Thickness
MP-0750V	0.750"	0.125"	0.906"	0.406"
MP-0875V	0.875"	0.125"	1.1016"	0.453"

**REMOVABLE VENTED NYLON PLUGS AVAILABLE, PLEASE INQUIRE!**

# ABS Insert Cap Glides

- ABS plastic end cap/glides are designed to insert inside steel tubing for heavy duty applications.
- ABS - hard plastic, matte finish.
- The two ideal uses for insert caps are floor glides and tubing end caps.

## S50-Series

### Square

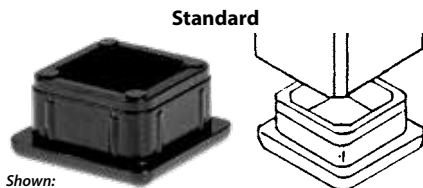

Shown:  
S50-3211BK

### Application



### PLEASE NOTE:

All sizes shown are outside dimensions of tube.

Insert caps are bulk packed for shipping, some scratching may occur.

Part#	Color	Outside Dim. Of Tube	Gauge Of Tubing
S50-1616BK	Black	1/2"	16
S50-1618WH	White ■	1/2"	18
S50-2016BK	Black	5/8"	16
S50-2018*	BK or WH ■	5/8"	18
S50-2414WH	White ■	3/4"	14
S50-2416BK	Black	3/4"	16
S50-2418BK	Black	3/4"	18
S50-2816*	BK or WH ■	7/8"	16
S50-3211BK	Black	1"	11
S50-3214BK	Black	1"	14
S50-3216BK	Black	1"	16
S50-3218BK	Black	1"	18
S50-3614WH	White ■	1-1/8"	14
S50-3616BK	Black	1-1/8"	16
S50-3618*	BK or WH ■	1-1/8"	18
S50-4011BK	Black	1-1/4"	11
S50-4014BK	Black	1-1/4"	14
S50-4016BK	Black	1-1/4"	16
S50-4018BK	Black	1-1/4"	18
S50-4811BK	Black	1-1/2"	11
S50-4814BK	Black	1-1/2"	14
S50-4816BK	Black	1-1/2"	16
S50-4818*	BK or WH ■	1-1/2"	18
S50-5611*	BK or WH ■	1-3/4"	11
S50-5614BK	Black	1-3/4"	14
S50-5616BK	Black	1-3/4"	16
S50-6411BK	Black	2"	11
S50-6414BK	Black	2"	14
S50-6416BK	Black	2"	16
S50-9611BK	Black	3"	11

■ WHILE SUPPLIES LAST

## S53-Series

### Round

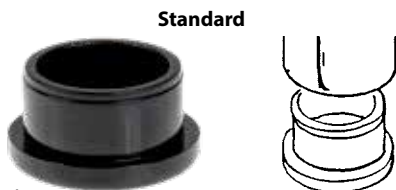

Shown:  
S53-3214BK

### Application



Part#	Color	Outside Dim. Of Tube	Gauge Of Tubing
S53-2018BK	Black	5/8"	18
S53-2416BK	Black	3/4"	16
S53-2418BK	Black	3/4"	18
S53-2816BK	Black	7/8"	16
S53-2818BK	Black	7/8"	18
S53-3214BK	Black	1"	14
S53-3216BK	Black	1"	16
S53-3218BK	Black	1"	18
S53-4014BK	Black	1-1/4"	14
S53-4018BK	Black	1-1/4"	18
S53-4816BK	Black	1-1/2"	16
S53-4818BK	Black	1-1/2"	18
S53-4820BK	Black ■	1-1/2"	20
S53-5618BK	Black ■	1-3/4"	18
S53-6416BK	Black	2"	16
S53-6418*	BK or WH ■	2"	18

■ WHILE SUPPLIES LAST

FOR QUANTITIES LESS THAN 100 PIECES AND VOLUME PRICING, PLEASE INQUIRE

OUTWATER INDUSTRIES, INC. • www.outwater.com

# Rectangular ABS Insert Cap Glides

- Rectangular ABS plastic end cap/glides are designed to insert inside steel tubing for heavy duty applications
- ABS - hard plastic, matte finish
- The two ideal uses for rectangular insert caps are floor glides and tubing end caps

## S56- Series

### Standard



Shown:  
S56-32-6414BK

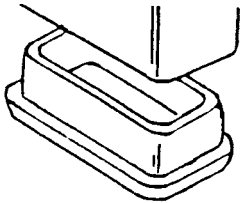

Part#	Color	Outside Dim. Of Tube	Gauge Of Tubing
S56-12-3220BK	Black ■	3/8" x 1"	20
S56-16-3216*	BK or WH ■	1/2" x 1"	16
S56-24-4816BK	Black	3/4" x 1-1/2"	16
S56-32-4814*	BK or WH	1" x 1-1/2"	14
S56-32-4815BK	Black ■	1" x 1-1/2"	15
S56-32-4816BK	Black	1" x 1-1/2"	16
S56-32-6414BK	Black	1" x 2"	14
S56-32-6416BK	Black	1" x 2"	16
S56-32-9611BK	Black ■	1" x 3"	11
S56-40-6416BK	Black ■	1-1/4" x 2"	16
S56-48-6411BK	Black	1-1/2" x 2"	11

■ WHILE SUPPLIES LAST

### Application



#### PLEASE NOTE:

All sizes shown are outside dimensions of tube.  
Insert caps are bulk packed for shipping, some scratching may occur.

**FOR QUANTITIES LESS THAN 100 PIECES AND VOLUME PRICING, PLEASE INQUIRE**

# Black Butyrate Insert Cap Glides

- Butyrate plastic end cap/glides are designed to insert inside steel tubing for heavy duty applications
- Butyrate - hard plastic, gloss finish
- The two ideal uses for insert caps are floor glides and tubing end caps
- Other sizes are available in Poly & ABS - please inquire

## S51- Series

### Square

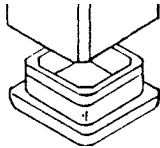

Part#	Outside Dim. Of Tube	Gauge Of Tube	Color
S51-3216BK	1"	16	Black
S51-3216CL	1"	16	Clear

NOTE: Shown are outside dimensions of tube.

# ABS Chrome-Plated Insert Cap Glides

- ABS Chrome-Plated Insert Cap Glides Are Designed To Insert Inside Steel Tubing For Heavy Duty Applications.
- These Caps Are Available In Various Sizes To Fit Your Appropriate Gauge Steel Tubing.
- Will Not Tarnish Or Rust!
- Shiny, Brite Mirror-Like Finish.
- Other Sizes & Finishes Available On A Special Order Basis - Minimums Apply - Please Inquire.

## S59 Series - Square Insert Caps



Part #	Outside Dia. Of Tube	Gauge Of Tubing	Finish
<b>S59-3216CH</b>	1"	16	Chrome
<b>S59-3218CH</b>	1"	18	Chrome

## S60 Series - Round Insert Caps



Part #	Outside Dia. Of Tube	Gauge Of Tubing	Finish
<b>S60-3214CH</b>	1"	14	Chrome
<b>S60-3216CH</b>	1"	16	Chrome
<b>S60-3218CH</b>	1"	18	Chrome

## S61 Series - Rectangular Insert Caps



Part #	Outside Dia. Of Tube	Gauge Of Tubing	Finish
<b>S61-16-4818CH</b>	1/2" x 1-1/2"	18	Chrome
<b>S61-32-6416CH</b>	1" x 2"	16	Chrome

## Plastic Caps

### Square Caps



\* **Black (BK) or White (WH)**  
Material: Low Density Polyethylene

Part #	Fits Over Tubing	Height
<b>S-16-*</b>	1/2"	.581"
<b>S-20-*</b>	5/8"	.593"
<b>S-24-*</b>	3/4"	.585"
<b>S-32-*</b>	1"	.582"

### Leg Protectors

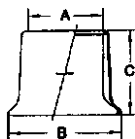

**Black**

Material: Low Density Polyethylene

Part #	Dimensions		
	A	B	C
<b>R71-510</b>	2"	3-1/8"	2-1/2"
<b>R71-511</b>	2-1/4"	3-3/8"	2-1/2"
<b>R71-512</b>	2-1/2"	3-5/8"	2-1/2"

### Heavy Caps

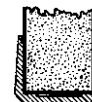

\* **Black (BK) or White (WH)**  
Material: Low Density Polyethylene

**(5/8" Tall)**

Part #	Iron Pipe	Fits Over Tubing
<b>AG-12-*</b>	1/8"	3/8"
<b>AG-16-BK</b>	1/4"	1/2"
<b>AG-16-WH</b>	1/4"	1/2"
<b>AG-20-BK</b>	3/8"	5/8"
<b>AG-20-WH</b>	3/8"	5/8"
<b>AG-24-*</b>	-	3/4"
<b>AG-28-*</b>	-	7/8"
<b>AG-32-*</b>	3/4"	1"
<b>AG-36-*</b>	-	1-1/8"
<b>AG-40-*</b>	1"	1-1/4"
<b>AG-48-*</b>	-	1-1/2"
<b>AG-52-BK</b>	1-1/4"	1-5/8"
<b>AG-52-WH</b>	1-1/4"	1-5/8"
<b>AG-56-BK</b>	-	1-3/4"
<b>AG-64-BK</b>	-	2"

**(1" Tall)**

Part #	Fits Over Tubing
<b>AH-20-WH</b>	5/8"
<b>AH-24-*</b>	
<b>AH-28-BK</b>	7/8"
<b>AH-28-WH</b>	7/8"
<b>AH-32-*</b>	1"

## Wire Tips

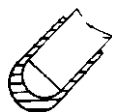

\* **Black (BK) or White (WH)**  
Material: Vinyl

Part #	Fits Over Wire	Height
<b>AW-6-*</b>	3/16"	.455"
<b>AW-8-BK</b>	1/4"	.455"

# Nickel-Plated Metal Spring Caps

- Nickel-Plated Metal Spring Caps Are Designed To Insert Inside Steel Tubing
- Fits 16 Or 18 Gauge Tubing
- These Caps Have A Shiny, Bright Finish
- These Caps Fit Flush With Edge And Provide An Excellent Finish For Tube Ends
- Other Finishes Are Available On A Special Order Basis - Please Inquire

## S68 Series

### Square Flat Metal Spring Caps



Part#	Outside Dia. Of Tube	Gauge Of Tubing	Finish
S68-24NP	3/4"	16, 18	Nickel Plated
S68-32NP	1"	16, 18	Nickel Plated

## S70 Series

### Round Domed Metal Spring Caps



Part#	Outside Dia. Of Tube	Gauge Of Tubing	Finish
S70-16NP	1/2"	16, 18	Nickel Plated
S70-20NP	5/8"	16, 18	Nickel Plated
S70-24NP	3/4"	16, 18	Nickel Plated
S70-28NP	7/8"	16, 18	Nickel Plated
S70-32NP	1"	16, 18	Nickel Plated
S70-40NP	1-1/4"	16, 18	Nickel Plated
S70-48NP	1-1/2"	16, 18	Nickel Plated
S70-64NP	2"	16, 18	Nickel Plated



- Low-Density Polyethylene
- Fits From 12 To 23 Gauge Tubing

- Perfect For Odd Gauge Tubing
- Color - Black And White Options

## Shark Finned Insert Caps



### Rectangle



Shown:  
SHK-12RT-BK

Part #	Tube O.D.	Gauge
SHK-12RT-BK	1" x 2"	11-19
DNW-RT3264-BK	1" x 2"	14-23
DNW-RT3264-WH	1" x 2"	14-23

### Square



Shown:  
SHK-32S-BK

Part #	Tube O.D.	Gauge
DNW-S24-BK	3/4"	14-23
DNW-S24-WH	3/4"	14-23
SHK-32S-BK	1"	12-18
DNW-S32-BK	1"	14-23
DNW-S32-WH	1"	14-23
SHK-48S-BK	1-1/2"	12-18
DNW-S48-BK	1-1/2"	14-23
DNW-S48-WH	1-1/2"	14-23
DNW-S56-BK	1-3/4"	14-18
SHK-64S-BK	2"	12-18

### Round



Shown:  
SHK-32R-BK

Part #	Tube O.D.	Gauge
SHK-32R-BK	1"	11-19
DNW-R32-WH	1"	14-23
SHK-40R-BK	1-1/4"	12-18
SHK-48R-BK	1-1/2"	11-19
SHK-96R-BK	3"	14-18

- Fits From 14-23 Gauge Tubing
- Provides Positive Fit
- Perfect For Odd Gauge Tubing (Ex. 15 Gauge, 17 Gauge, Etc)

- Advanced Textured Top, Resists Scarring & Scratching
- All Sizes Stocked In Black And White Unless Specified
- Low-Density Polyethylene

### For Rectangular Tubing



\* Black (BK) or White (WH)

Part #	Tube O.D.	Cap Height
P32-U64.*	1" x 2"	.78"
RCR-12RT-WH^	1" x 2"	.47"
P32-U96-BK	1" x 3"	.65"
P48-U96.*	1-1/2" x 3"	.781"
P64-U96.*	2" x 3"	.780"

^ Fits 11-19 Gauge Tubing

### For Square Tubing

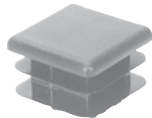

\* Black (BK) or White (WH)

Part #	Tube O.D.	Cap Height
T24-U2.*	3/4"	.657"
T28-U2.*	7/8"	.656"
T32-U2.*	1"	.656"
T40-U2.*	1-1/4"	.655"
T48-U2.*	1-1/2"	.71"
T64-U2.*	2"	.78"
T80-U2-BK	2-1/2"	.781"

### For Round Tubing



Domed round caps are smooth

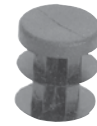

\* Black (BK) or White (WH)

Part #	Tube O.D.	Cap Height	Part #	Tube O.D.	Cap Height
C20-U21.*	5/8"	.818"	C16-U2.*	1/2"	.60"
C24-U21.*	3/4"	.8325"	C20-U2.*	5/8"	.542"
C28-U21.*	7/8"	.831"	C24-U2.*	3/4"	.645"
C32-U21.*	1"	.86"	C28-U2.*	7/8"	.64"
C40-U21.*	1-1/4"	1.25"	C32-U2.*	1"	.67"
C48-U21.*	1-1/2"	1.375"	C36-U2-BK	1-1/8"	.67"
C56-U21-BK	1-3/4"	.625"	C40-U2.*	1-1/4"	.835"
			C48-U2.*	1-1/2"	.789"
			C56-U2.*	1-3/4"	.790"
			C64-U2-BK	2"	.780"



# Double Star Metal Tube Connectors W/Thread

- Metal startype inserts are designed to insert inside steel tubular legs.
- These inserts are available in various sizes to fit 16 or 18 gauged steel tubing and thread size.
- External edges fit flush with outside edge of tubing for a clean, finished appearance.

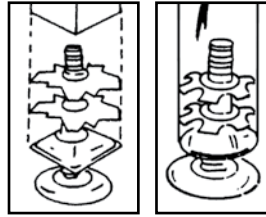

**IDEAL FOR CASTERS!**

## Square DS71 Series

### 5/16-18 THREAD



Part #	Thread	Outside Dia. Of Tube	Gauge Of Tube
<b>DS71-245</b>	5/16-18	3/4"	16/18
<b>DS71-325</b>	5/16-18	1"	16/18
<b>DS71-365</b>	5/16-18	1-1/8"	16/18
<b>DS71-405</b>	5/16-18	1-1/4"	16/18
<b>DS71-485</b>	5/16-18	1-1/2"	16/18
<b>DS71-645</b>	5/16-18	2"	16/18

### 3/8-16 THREAD



Part #	Thread	Outside Dia. Of Tube	Gauge Of Tube
<b>DS71-326</b>	3/8-16	1"	16/18
<b>DS71-366</b>	3/8-16	1-1/8"	16/18
<b>DS71-406</b>	3/8-16	1-1/4"	16/18
<b>DS71-486</b>	3/8-16	1-1/2"	16/18
<b>DS71-646</b>	3/8-16	2"	16/18

## Round DS72 Series

### 5/16-18 THREAD



Part #	Thread	Outside Dia. Of Tube	Gauge Of Tube
<b>DS72-245</b>	5/16-18	3/4"	16/18
<b>DS72-325</b>	5/16-18	1"	16/18
<b>DS72-365</b>	5/16-18	1-1/8"	16/18
<b>DS72-405</b>	5/16-18	1-1/4"	16/18
<b>DS72-485</b>	5/16-18	1-1/2"	16/18
<b>DS72-645</b>	5/16-18	2"	16/18

### 3/8-16 THREAD



Part #	Thread	Outside Dia. Of Tube	Gauge Of Tube
<b>DS72-326</b>	3/8-16	1"	16/18
<b>DS72-366</b>	3/8-16	1-1/8"	16/18
<b>DS72-406</b>	3/8-16	1-1/4"	16/18
<b>DS72-486</b>	3/8-16	1-1/2"	16/18
<b>DS72-646</b>	3/8-16	2"	16/18

## Metal Tube Connectors



- Heavy duty tube connector application.
- "Double" star tube connectors are designed to grip inside of round or square steel tubing.



- Light duty tube connector application.
- Washers grip inside of round steel tubing.



Round or Square adaptor fits 16/18 Gauge tubing for 7/16" x 1-1/2" friction ring stem caster

Part#	Member O.D.		Gauge Of Tube
	Flat To Flat	Thread	
<b>S67-204</b>	5/8"	1/4-20	16/18
<b>S67-244</b>	3/4"	1/4-20	16/18
<b>S67-324</b>	1"	1/4-20	16/18
<b>S67-404</b>	1-1/4"	1/4-20	16/18

Part#	Member O.D.		Gauge Of Tube
	Flat To Flat	Thread	
<b>S73-244</b>	3/4"	1/4-20	16/18
<b>S73-324</b>	1"	1/4-20	16/18

Part #	Adaptor	Gauge Of Tube
<b>DSFRW-485</b>	1-1/2" Round	16/18
<b>DSFRS-325</b>	1" Square	16/18
<b>DSFRS-485</b>	1-1/2" Square	16/18

**FOR QUANTITIES LESS THAN 100 PIECES, PLEASE INQUIRE**

- Metal startype inserts are designed to insert inside steel tubular legs.
- These inserts are available in various sizes to fit 16 or 18 gauged steel tubing and thread size.
  - External edges fit flush with outside edge of tubing for a clean, finished appearance.
  - To be used with levelers, not recommended to use with casters.

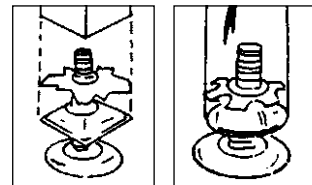

## Square S62/S71 Series



Part #	Square	Outside Dia. Of Tube	Gauge Of Tube	Part #	Square	Outside Dia. Of Tube	Gauge Of Tube
S71-204	1/4-20	5/8"	16/18	S62-365	5/16-18	1-18"	16/18
S71-244	1/4-20	3/4"	16/18	S71-405	5/16-18	1-1/4"	16/18
S62-284	1/4-20	7/8"	16/18	S71-485	5/16-18	1-1/2"	16/18
S71-324	1/4-20	1"	16/18	S71-645	5/16-18	2"	16/18
S62-364	1/4-20	1-1/8"	16/18	S62-286	3/8-16	7/8"	16/18
S71-404	1/4-20	1-1/4"	16/18	S71-326	3/8-16	1"	16/18
S71-484	1/4-20	1-1/2"	16/18	S62-366	3/8-16	1-1/8"	16/18
S71-644	1/4-20	2"	16/18	S71-406	3/8-16	1-1/4"	16/18
S62-285	5/16-18	7/8"	16/18	S71-486	3/8-16	1-1/2"	16/18
S71-325	5/16-18	1"	16/18	S71-646	3/8-16	2"	16/18

## Round S63/S72 Series



Part #	Round	Outside Dia. Of Tube	Gauge Of Tube	Part #	Round	Outside Dia. Of Tube	Gauge Of Tube
S72-204	1/4-20	5/8"	16/18	S72-405	5/16-18	1-1/4"	16/18
S72-244	1/4-20	3/4"	16/18	S72-485	5/16-18	1-1/2"	16/18
S63-284	1/4-20	7/8"	16/18	S72-645	5/16-18	2"	16/18
S72-324	1/4-20	1"	16/18	S63-725	5/16-18	2-1/4"	16/18
S63-364	1/4-20	1-1/8"	16/18	S63-286	3/8-16	7/8"	16/18
S72-404	1/4-20	1-1/4"	16/18	S72-326	3/8-16	1"	16/18
S72-484	1/4-20	1-1/2"	16/18	S63-366	3/8-16	1-1/8"	16/18
S72-644	1/4-20	2"	16/18	S72-406	3/8-16	1-1/4"	16/18
S63-724	1/4-20	2-1/4"	16/18	S72-486	3/8-16	1-1/2"	16/18
S63-285	5/16-18	7/8"	16/18	S63-566	3/8-16	1-3/4"	16/18
S72-325	5/16-18	1"	16/18	S72-646	3/8-16	2"	16/18
S63-365	5/16-18	1-1/8"	16/18	S63-726	3/8-16	2-1/4"	16/18

FOR QUANTITIES LESS THAN 100 PIECES, PLEASE INQUIRE

# Metal Threaded Grater Clips

- Square metal threaded grater clips are designed to insert inside square steel tubing
- External edges fit flush with the outside lip of tubing
- These clips are available in various sizes to fit 16 or 18 gauge steel tubing and various thread sizes
- Other gauges are available through special order. Minimums apply -please inquire
- These clips are barbed and flexible for fastening
- Heat treated and plated to resist rusting (steel with .060 thickness)



## Four-Sided

Part#	Outside Dim. Of Tube	Gauge Of Tubing	Thread Hole Size
S645-324	1"	16,18	1/4-20



## Four-Sided (Heavy Duty)

Part#	Outside Dim. Of Tube	Gauge Of Tubing	Thread Hole Size
S65-324	1"	16,18	1/4-20
S65-325	1"	16,18	5/16-18
S65-326	1"	16,18	3/8-16
S65-404	1-1/4"	16,18	1/4-20
S65-405	1-1/4"	16,18	5/16-18
S65-406	1-1/4"	16,18	3/8-16
S65-486	1-1/2"	16,18	3/8-16

Four-sided grater clips can be used as caster inserts in light duty applications.

# Plastic Threaded Insert Caps

## Black Nylon Caps w/Metal Thread

- HDPE with zinc plated steel threaded insert
- Ribbed to fit 16-18 gauge tubing unless noted

### Square S27 Series



Part#	Outside Dim. Of Tube	Gauge Of Tubing	Thread
S27-244BK	0.75"	16-18	1/4-20
S27-324BK	1"	16-18	1/4-20
S27-326BK	1.5"	16-18	3/8-16
S27-328BK	1"	16-18	5/16-18
S27-406BK	1.25"	16-18	3/8-16

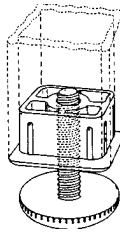

Material: White Nylon  
3/8" HOLE - 1/4-20 THREAD

Part#	Dimensions	
	A	B
PG-1	3/8"	1/2"

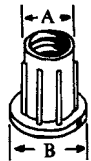

### Round S28 Series



S28-324BK	1"	16-18	1/4-20
S28-328BK	1"	16-18	5/16-18
S28-408BK	1.25"	16-18	5/16-18
S28-488BK	1.5"	16-18	5/16-18

### Rectangle S29 Series



S29-24-484BK	0.75" x 1.5"	16-18	1/4-20
S29-24-486BK	0.75" x 1.5"	16-18	5/16-18
S29-32-484BK	1" x 1.5"	16-18	1/4-20
S29-32-488BK	1" x 1.5"	16-18	5/16-18
S29-64-328BK	2" x 1"	16-18	5/16-18
S29-64-32148BK	2" x 1"	14-16	5/16-18

## Square Nylon Caps with Nylon Thread

- Threaded insert cap designed to fit 16 or 18 gauge
- Caps fit inside steel tubing

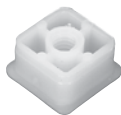

(White)

Part#	Outside Dim. Of Tube	Gauge Of Tubing	Thread	Color
S27-265WH	1"	16	1/4-20	White
S27-269BK	1"	18	5/16-18	Black

# Metal Threaded Inserts

## Tee Nuts

- Tee nuts are an economical method of fastening a threaded stem leveler to a wood component.
- 4 prong tee nuts can be used in either hard or soft wood.

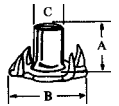

Part#	Thread	Dimensions		
		A	B	C
T-NUT250	1/4-20	5/16"	3/4"	5/16"
T-NUT3125	5/16-18	3/8"	7/8"	3/8"
T-NUT375	3/8-16	7/16"	1"	1/2"

## Propeller Nuts

- Propeller nuts provide excellent retention for blind applications such as levelers.
- Can be used in hard plastic applications.

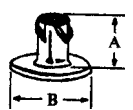

Part#	Thread	Dimensions	
		A	B
P-NUT250	1/4-20	1/2"	5/8"
P-NUT3125	5/16-18	3/8"	7/8"
P-NUT375	3/8-16	7/16"	1"

# Insert Nuts

- Available with & without flange.
- Offers high retention values in blind & edge grain applications.
- Features hex drive for quick engagement.
- With flange allows for flush applications; without flange allows insert to be set below the surface.
- May be used with threaded stem casters.

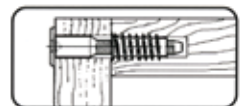
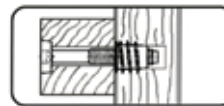
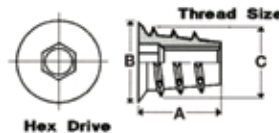

Part#	Type	Thread	Dimensions		
			A	B	C
I-NUT250	No Flange	1/4-20	.512"	-	.453"
I-NUT3125	No Flange	5/16-18	.512"	-	.559"
I-NUT250F	With Flange	1/4-20	.512"	.492"	.461"
I-NUT3125F	With Flange	5/16-18	.512"	.571"	.531"
I-NUT375F	With Flange	3/8-16	.512"	.630"	.594"



The longest lasting felt glide on the market today.

- Our glides will outlast all others 3 to 1 in comparison.
- Great for table and chairs. Especially when used in commercial applications such as schools, restaurants, offices and rest areas!

**Your Floors never "Felt" so Good!**

## Felt Bottom Adjustable Leveler

**Brown PE base with Gray Felt bottom**



Part #	Base	Thread	Stem	Height
<b>SGL-324</b>	1"	1/4-20	1"	.455
<b>SGL-325</b>	1"	5/16-18	1"	.455



## Felt Bottom Nail-On Glide

**Brown or White PE Base with Gray Felt Bottom**

MEDIUM DUTY			Head		Nail		
Part #	Color	Shape	Dia.	Thick.	Dia.	Length	Sharp
<b>R33F-92BR</b>	Brown	Flat	3/4"	21/64"	5/64"	19/32"	x
<b>R33F-92WH</b>	White	Flat	3/4"	21/64"	5/64"	19/32"	x
<b>R33F-93WH</b>	White	Flat	7/8"	21/64"	5/64"	19/32"	x
<b>R33F-94BR</b>	Brown	Flat	1"	21/64"	5/64"	19/32"	x
<b>R33F-94WH</b>	White	Flat	1"	21/64"	5/64"	19/32"	x
<b>R33F-95BR</b>	Brown	Flat	1-1/8"	21/64"	5/64"	19/32"	x
<b>R33F-95WH</b>	White	Flat	1-1/8"	21/64"	5/64"	19/32"	x

LIGHT DUTY			Head		Nail		
Part #	Color	Shape	Dia.	Thick.	Dia.	Length	Sharp
<b>SGLT-24WH</b>	White	Flat	1"	11/32"	1/16"	35/64"	x
<b>SGLT-28WH</b>	White	Flat	1-1/8"	11/32"	1/16"	35/64"	x

## Super Leveler

- 125 lb. load rating.
- The most complete and versatile types of automatic self leveling glides.
- Eliminates wobble by instantly self-leveling to any uneven surface.
- Adjusts to 1/4" of wobble.
- No manual adjustment needed.
- Corrosion resistant.
- Use indoors & outdoors.
- Built to last with high-grade impact plastic and heat treated stainless steel.
- Installs by hand - no tools needed.



Part #	Thread Size	Base Diameter	Installed Height	Maximum Load Rating	Movement System
<b>SL-250BK-4PK</b>	1/4"-20 x .375"	1.28"	.92"	125 lbs. per glide, 500 lbs. per set	Spring & Ramp Mechanism

## Super Shock



- 100 lb. load rating.
- Same function as the super leveler but slightly larger profile.
- Automatically adjusts up to 5/16"
- 3/8" Long threaded stem

Part #	Thread Size	Base Diameter	Installed Height	Maximum Load Rating	Movement System
<b>SPS-250BK</b>	1/4"-20 x .375	1.50"	1.15"	100 lbs. per glide, 400 lbs. per set	Hydraulic
<b>SPS-3125BK-4PK</b>	5/16"-18 x .375	1.50"	1.15"	100 lbs. per glide, 400 lbs. per set	Hydraulic
<b>SPS-375BK</b>	3/8"-16 x .375	1.50"	1.15"	100 lbs. per glide, 400 lbs. per set	Hydraulic

## Corner Block w/Barb Nut

5/16-18 Thread • Black



R44N-952BK



R448N-952BK

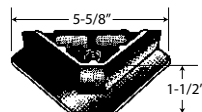

Part #	Material	Barb Nut Placement
<b>R44N-952BK</b>	Nylon	Top
<b>R448N-952BK</b>	Nylon - reversed thread	Underside

## Regal Swivel Glide

**Fits 16-18 Gauge Tubing**  
**Nickel Plated Steel**



All glides have a nickel plated shell. Please specify base material: N = white nylon or S = steel.



Part #	Base	Fits Tube Dia.	Ferrule Height
<b>REGAL-10</b>	1-1/4"	5/8"	9/16"
<b>REGAL-11</b>	1-1/4"	3/4"	9/16"
<b>REGAL-12</b>	1-1/4"	7/8"	1/2"

**FOR QUANTITIES LESS THAN 100 PIECES, PLEASE INQUIRE**

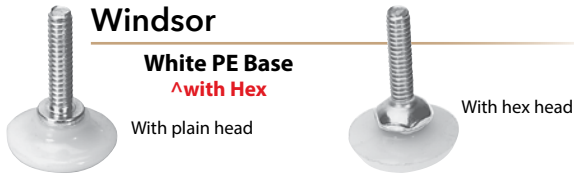

## Windsor

White PE Base  
^with Hex

With plain head

With hex head

Part #	A	B	C	D
■ ^WINDSOR-11	1-1/8"	1/4-20	1"	.6693
■ WINDSOR-14	1-1/8"	1/4-20	1"	.5512
■ ^WINDSOR-21	1-1/8"	5/16-18	1"	.6693
■ ^WINDSOR-22	1-1/8"	5/16-18	1-1/2"	.6693

**LEVELER SPECIFICATIONS**  
For All Levelers  
Shown:

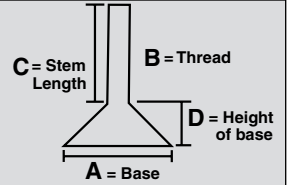

## Small Oval Base Leveler

HDPE Base

Part #	Colors	A	B	C	D
■ R33-124	White	5/8"	1/4-20	1"	1/4"
R33-130	Beige or White	3/4"	1/4-20	1"	1/4"
R33-131	■ Beige	7/8"	1/4-20	1"	1/4"
R33-132	White	1"	1/4-20	1"	1/4"
R33-139	White	1-1/8"	1/4-20	5/8"	1/4"



## Windsor

Clear K-Resin Base

Part #	A	B	C	D
WL78	1-1/8"	1/4-20	1"	.3937



## Thick Base Leveler

HDPE Base

Part #	Color	A	B	C	D
R33-358BK	Black	1-1/8"	5/16-18	1-1/2"	3/8"
R33-5340BK	Black	7/8"	5/16-18	1"	1/4"



## Large Flat Base Leveler

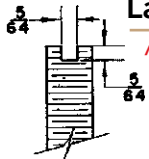

^Screw Slot

HDPE Base

Part #	Colors	A	B	C	D
R33-122	Black or White	1-1/2"	5/16-18	1-1/2"	19/64"
R33-123	Black	1-1/2"	1/4-20	1"	19/64"
R33-355	Black or White	1-1/2"	1/4-20	1-1/2"	19/64"
■ ^R33-516	Black or White	1-1/2"	3/8-16	1-1/2"	19/64"
R33-6010	Black	2"	3/8-16	1"	25/64"
^R33-6011	Black	1-3/4"	3/8-16	1-1/2"	21/64"



## Hex Base Leveler

Black Nylon Base

Part #	A	B	C	D	Hex Dia.
■ PL4-250	1"	1/4-20	1"	27/64"	5/8"
PL4-3125	1"	5/16-18	1"	27/64"	5/8"
■ PL4-375	1"	3/8-16	1"	7/16"	5/8"
■ PL6-250	1"	1/4-20	1-1/2"	27/64"	5/8"
■ PL6-3125	1"	5/16-18	1-1/2"	27/64"	5/8"
PL6-375	1"	3/8-16	1-1/2"	7/16"	5/8"
PL7-250	1-1/4"	1/4-20	1"	27/64"	7/8"
PL7-3125	1-1/4"	5/16-18	1"	27/64"	7/8"
■ PL7-375	1-1/4"	3/8-16	1"	27/64"	7/8"
PL8-250	1-1/4"	1/4-20	1-1/2"	27/64"	7/8"
■ PL8-3125	1-1/4"	5/16-18	1-1/2"	27/64"	7/8"
■ PL8-375	1-1/4"	3/8-16	1-1/2"	27/64"	7/8"



## Swivel Base Leveler

HDPE Base

25° Angle

Part #	Color	A	B	C	D
R33-134BK	Black	1-1/8"	1/4-20	1"	.455'
R33-134WH	White	1-1/8"	1/4-20	1"	.455'



## Robot Non-Skid Leveler

Thermoplastic Rubber Black Base

Part #	A	B	C	D
■ ROBOT10	1-1/8"	1/4-20	1"	27/64"
■ ROBOT12	1-1/8"	5/16-18	1"	27/64"
■ ROBOT14	1-1/8"	3/8-16	1"	27/64"



## With Screw Slot Beige HDPE Base

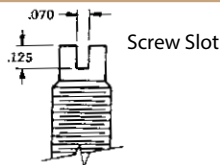

Part #	A	B	C	D
R33-7000BE	1-1/8"	5/16-18	4"	1/4"



## Slotted Hex Leveler

Black Nylon Base

Part #	A	B	C	D
R33-6600BK	1"	5/16-18	1-1/2"	.275



FOR QUANTITIES LESS THAN 100 PIECES, PLEASE INQUIRE

**LEVELER SPECIFICATIONS**  
For All Levelers  
Shown:

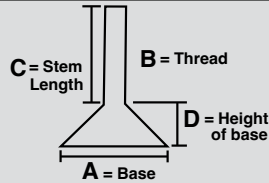

**Cushion Glide Leveler**



Nickel Plated Shell With Black HDPE Base

Part #	A	B	C	D
■ CG100	7/8"	1/4-20	1"	3/8"
■ CG102	1-1/16"	1/4-20	1"	3/8"
■ CG103	1-1/16"	5/16-18	1"	3/8"
■ CG104	1-1/4"	5/16-18	1"	3/8"

Zinc Plated Shell With Black Base

Part #	A	B	C	D
■ CG105	1-1/4"	3/8-16	1"	7/16"

**Monaco Swivel**

Nickel Plated With White Nylon Base

Part #	A	B	C	D
■ MONO-10	1-1/8"	1/4-20	1/2"	37/64"
■ MONO-11	1-1/8"	1/4-20	1"	37/64"
■ MONO-12	1-1/8"	5/16-18	1"	37/64"
■ MONO-13	1-1/8"	5/16-18	1-1/2"	37/64"
■ MONO-14	1-1/8"	3/8-16	1"	37/64"
■ MONO-15	1-1/8"	3/8-16	1-1/2"	37/64"



Swivel >

**Monaco Non-Swivel**

Nickel Plated With White PE Base

Part #	A	B	C	D
■ MONO-30	1-1/8"	1/4-20	1"	.6693
■ MONO-31	1-1/8"	5/16-18	1"	.6693
■ MONO-32	1-1/8"	5/16-18	1-1/2"	.6693
■ MONO-33	1-1/8"	3/8-16	1"	.6693
■ MONO-34	1-1/8"	3/8-16	1-1/2"	.6693



Non-Swivel >

**Monaco Adjustable Leveler**

Nickel Plated With White Nylon Base  
Slotted Bolt Swivel With Hex Base

Part #	A	B	C	D	O.A. HT.
■ R33-7500	1-1/2"	3/8-16	1-1/2"	5/8"	2"
■ R33-7510	1-1/2"	3/8-16	2-1/2"	5/8"	3"
■ R33-7520	1-1/2"	3/8-16	3"	5/8"	3-1/2"
■ R33-7530	1-1/2"	3/8-16	3-1/2"	5/8"	4"
■ R33-7540	1-1/2"	3/8-16	4"	5/8"	4-1/2"



**"Big Foot" Leveler with Hex Nut**

Nickel Plated With Black Nylon Base

Part #	A	B	C	D
■ BFL-375BK	2-1/2"	3/8-16	1-1/2"	.48"
■ BFL-3125BK	2-1/2"	5/16-18	1-1/2"	.48"



**Titan**

Nickel Plated With White HDPE Base  
^without Hex

< With plain head

With hex head >



Part #	A	B	C	D
■ TITAN-10	1"	1/4-20	1"	.5512
■ ^TITAN-11	1-3/8"	1/4-20	1"	.5906
■ ^TITAN-13	1-11/16"	1/4-20	1"	.5906
■ TITAN-14	1-3/8"	5/16-18	1"	.7087
■ TITAN-16	1-3/8"	5/16-18	1-1/2"	.7087
■ TITAN-17	1-11/16"	5/16-18	1"	.7087
■ TITAN-19	1-11/16"	5/16-18	1-1/2"	.7087
■ TITAN-20	1-3/8"	3/8-16	1"	.7087
■ TITAN-22	1-3/8"	3/8-16	1-1/2"	.7087
■ TITAN-23	1-11/16"	3/8-16	1"	.7087
■ TITAN-25	1-11/16"	3/8-16	1-1/2"	.7087

**Metal Levelators**

**K-75- 3/8" Thread 3" or 4" Long**

Corner Brace With Slotted Leveler & Hex Nut  
Set Includes 1 Brace & 1 Leveler



Part #	Description
K-75-3	3/8" x 3" Long
K-75-4	3/8" x 4" Long

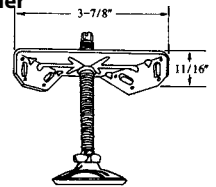

K-75 BRACE ONLY

**LI-158- 3/8" Thread 3" or 4" Long**

Support Brace With Slotted Leveler & Hex Nut  
Set Includes 1 Brace & 1 Leveler



Part #	Description
■ LL-158-3	3/8" x 3" Long
■ LL-158-4	3/8" x 4" Long

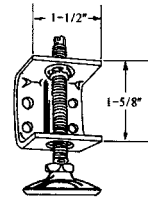

LL-158 BRACE ONLY  
LL-159 5/16-18 BRACE ONLY

**WL-218- M10 Thread 2-1/2" Long**

Support Brace With Leveler (adjust with 5mm hex key)  
Set Includes 1 Brace & 1 Leveler

Black Polypropylene Base



Part #	Description
■ WL-218-25	M10 x 2-1/2" Long

WL-218-25-B BRACE ONLY  
PL7-M10 LEVELER ONLY

Mounts with #6 or #8 screw, - see page G-32

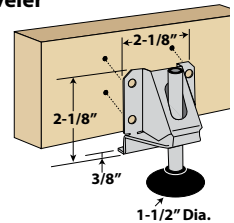

**Long Stem Leveler**

Zinc Plated Metal Glide with a Co-Polymer Plastic Base  
Socket and Nut Included

Part #	A	B	C	D
■ BG-38-4	2-5/16"	3/8-16	4-3/4"	.638



# Concealed Furniture Levelers

**Material:** Stainless Steel Core w/Black Polypropylene Base



- Sturdy metal levelers won't bend when moving furniture and no need to lift furniture
- One person adjustment with #4 hex key (sold separately)
- Up to 1" height adjustment (11/16" on CFL-1125)
- 660 lb. load capacity per leveler
- Drilling template & 12 mm drill bit available
- Minimum side board depth is 5/8" (16mm)

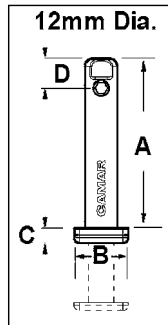

Part #	A	B	C	D
<b>CFL-1125</b>	1-1/4"			
<b>CFL-2000</b>	2"			
<b>CFL-2875</b>	2-7/8"	13/16" x 5/8"	7/32"	7/16"
<b>CFL-4000</b>	4"			
<b>CFL-4750</b>	4-3/4"			

Part #	Description
<b>CFL-HEX</b>	#4 Hex Key for concealed furniture leveler
<b>CFL-TEMP</b>	Drill Template for concealed furniture leveler
<b>CFL-BIT</b>	12mm Drill Bit for concealed furniture leveler

## INSTALLATION

**1**

**CFL-TEMP**

Use the Template to drill the placement hole.

**2**

**CFL-BIT**

**CFL-TEMP**

Drill the adjustment hole.

**3**

**LEVELER**

Insert 12mm Concealed Leveler into placement hole.

**4**

**CFL-HEX**

Adjust as needed through adjustment hole.

# Heavy Duty Furniture Levelers

**Material:** Iron Leveler with ABS Foot



- For wall units & furniture
- 220 lbs. or 330 lbs. capacity per leveler
- 3/4" height adjustment

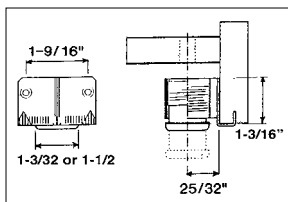

Part #	Load Capacity	Foot Diameter
<b>LL-220L</b>	220 lbs.	1-3/32"
<b>LL-330L</b>	330 lbs.	1-1/2"

LL-220L installs with 6mm Hex head screws (not included)  
 LL-330L installs with 6# Panhead screws (not included)

# Black Rubber-Like Non-Skid Case Feet

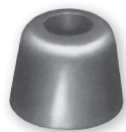

**Material:** Polyastomer\*

- Use on: bread boxes, cutting boards, cook book holders, etc.
- Also used as heavy duty bumpers for hinged & sliding doors.
- Use wood or machine screws (See screw chart below).
- Other sizes available - please inquire.
- Approximately 1/4" high.

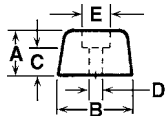

**Approx. Bottom**

Part #	Dia.	A	B	C	D	E	Uses Screw
R29-0421	1/2"	.25"	.50"	.10"	.15"	.28"	A
R29-0425	3/4"	.28"	.75"	.16"	.17"	.38"	B
R29-0425BR	3/4"	.28"	.75"	.16"	.17"	.38"	B
R29-0447	1"	.31"	1.00"	.13"	.18"	.60"	B

# Plastic Slippery Case Feet

**BROWN & BLACK**



**Material:** High Density Polyethylene

- Ideal use: Floor glides on movable furniture.
- Easily attached to wood, metal or plastic with wood screws - **NOT INCLUDED**.
- Multi-ribbed design gives exceptional strength for heavy loads.
- Use wood or machine screws (See screw chart below).

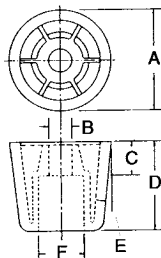

Part #	A	B Hole Dia.	C	D	E Taper	F	Uses Screw	Color
R29-140BK	7/8"	13/64"	1/4"	1/2"	10°	3/8"	B	Black
R29-142BK	1"	13/64"	3/8"	3/4"	8°	3/8"	C	Black
R29-142BR	1"	13/64"	3/8"	3/4"	8°	3/8"	C	Brown
R29-144BK	1-1/8"	1/4"	3/8"	1"	6°	1/2"	D	Black
R29-144BR	1-1/8"	1/4"	3/8"	1"	6°	1/2"	D	Brown
R29-275BK	7/8"	5/32"	3/16"	3/8"	8°	5/16"	A	Black

For quantities less than 100 pieces, please inquire.

## Screw Chart

Screw Part #	Description
A SCR-6625PHZ	#6 x 5/8" Pan Head Zinc
B SCR-8625PHZ	#8 x 5/8" Pan Head Zinc
C SCR-8100PHZ	#8 x 1" Pan Head Zinc
D SCR-1750PHZ	#10 x 3/4" Pan Head Zinc



**Material:** PVC/Polystyrol/Polystyrene

- Non-skid
- Non-marring
- Safe for hardwoods & tile floors
- Single screw application
- Extremely low profile only 3/8" height
- Works with 3/16" x 1" screw - **NOT INCLUDED**

Part #	Diameter
LPG-24BK	24mm
LPG-28BK	28mm

Also available in brown and white, minimum required - please inquire.



## Plastic Headed Tacks

Material: HDPE

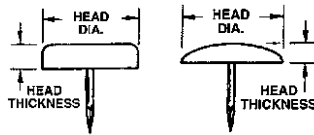

Part #	Color	Head		Nail			
		Shape	Dia.	Thick.	Dia.	Length	Sharp
R33-72WH	White	Oval	1/2"	3/16"	.072	11/16"	x
R33-72BE	Beige	Oval	1/2"	3/16"	.072	11/16"	x
R33-70BE	Beige	Oval	1/2"	1/4"	.072	11/16"	x
R33-73WH	White	Oval	5/8"	3/16"	.072	11/16"	x
R33-73BE	Beige	Oval	5/8"	3/16"	.072	11/16"	x
R33-18WH	White	Flat	5/8"	3/16"	.072	11/16"	x
R33-18BE	Beige	Flat	5/8"	3/16"	.072	11/16"	x
R33-91WH	White	Flat	5/8"	1/4"	.072	11/16"	x
R33-91BE	Beige	Flat	5/8"	1/4"	.072	11/16"	x
R33-2018DBR	Dk. Brown	Flat	5/8"	1/4"	.072	1/2"	x
R33-74BE	Beige	Oval	3/4"	3/16"	.072	11/16"	x
R33-19WH	White	Flat	3/4"	3/16"	.072	11/16"	x
R33-19BE	Beige	Flat	3/4"	3/16"	.072	11/16"	x
R33-92WH	White	Flat	3/4"	1/4"	.072	11/16"	x
R33-92BE	Beige	Flat	3/4"	1/4"	.072	11/16"	x
R33-75WH	White	Oval	7/8"	3/16"	.072	11/16"	x
R33-75BE	Beige	Oval	7/8"	3/16"	.072	11/16"	x
R33-79WH	White	Oval	7/8"	3/16"	.072	1/2"	x
R33-79BE	Beige	Oval	7/8"	3/16"	.072	1/2"	x
R33-20BE	Beige	Flat	7/8"	3/16"	.072	11/16"	x
R33-93WH	White	Flat	7/8"	1/4"	.072	11/16"	x
R33-93BE	Beige	Flat	7/8"	1/4"	.072	11/16"	x

## Plastic Nail Bumpers

Material: HDPE

R34-106

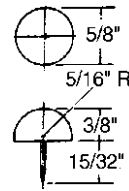

Part #	Color
R34-106BR	Brown
R34-106WH	White

R34-105

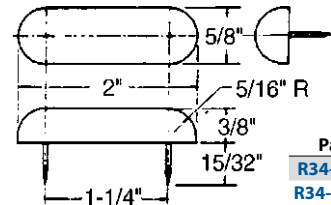

Part #	Color
R34-105BR	Brown
R34-105WH	White

## Plastic Corner Glide

Material: Beige HDPE

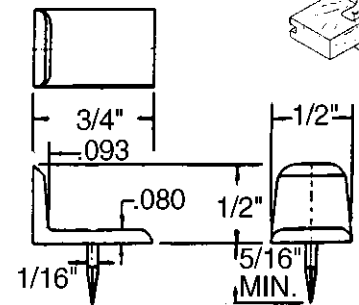
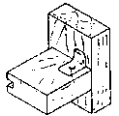

Part #  
R33-21BE

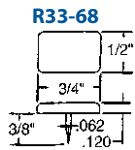
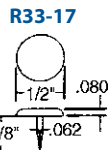
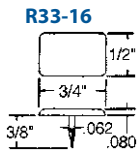

Part #	Color
R33-16BE	Beige
R33-16WH	White
R33-17BE	Beige
R33-68BE	Beige

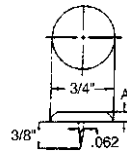

Part #	A	Color
R33-579BR	1/8"	Brown
R33-600BR	3/32"	Brown

## 1 Or 3 Prong Nail-On Glides Nickel Plated Steel

**1-PRONG GLIDES** are precision stamped with shanks tightly wedged into heavy heads. Points are sharp-easily driven. Supplied in high quality nickel plated steel.

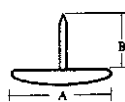

Part #	A	B
H-12	1/2"	1/2"
H-58	5/8"	5/8"
H-34	3/4"	3/4"

**3-PRONG GLIDES** are measured according to inside diameter, thus oversized. Precision stamped with long, sharp prongs. Supplied in heavy gauge, high quality nickel plated steel.

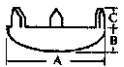

Part #	A	B	C
HGL-58	5/8"	13/64"	13/64"
HGL-34	3/4"	13/64"	1/4"
HGL-78	7/8"	1/4"	15/64"

## Nail-On Cushion Glides Nickel Plated Base With Rubber Cushion



Nail-On Glides with rubber cushion provides maximum floor protection, reduces vibration and noise and absorbs shock. Supplied with nickel plated base.

NICKEL PLATED NAIL-ON CUSHION GLIDE			
Part #	Base Dia.	Base Ht.	Nail Length
NCG-875	7/8"	13/32"	.740"
NCG-1062	1-1/8"	13/32"	.675"

*For quantities less than 100 pieces, please inquire.*

## Staple-On Strip Glide

- **Material:** HDPE
- Strip glides are molded 8 glides per strip for easy installation.
- Position first glide on leg. Hold remaining strip in your hand and drive staple through glide into the leg.
- Lift and twist remaining strip off.
- Use galvanized staples to prevent rust.
- Use staples at least 3/4" long.

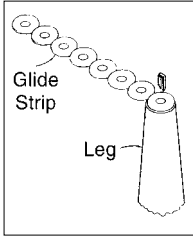

Lift, twist & separate strip from installed glide

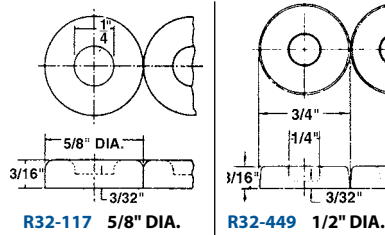

Part #	Color
R32-117BE	Beige
R32-449WH	White
R32-449DB	Dk. Brown

## In-Plant Floor Glide

- **Material:** HDPE
- Use to make moving furniture easier during manufacturing.
- Glide is stapled to frame rail or stretcher
- Glides are disposable

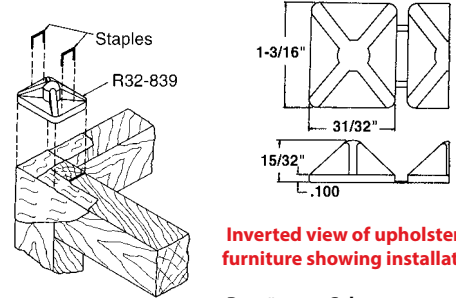

Part #	Color
R32-839	White

## Stud Type Button Glides

- **Material:** HDPE
- Slippery, self-lubricating plastic glide.
- Glides are soft, yet tough and resilient.
- Button glides install into a round drilled or punched hole.
- May be installed in wood, sheet metal or other materials.

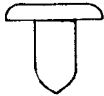

Part #	Color
R31-151WH	White
R31-156WH	White

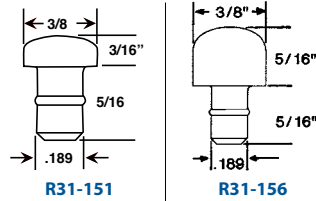

## Ganging Clip

**Material:** HDPE

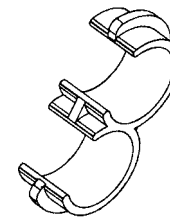

Designed for connecting 1" round chair legs together so chairs stay even in rows. Can also be used for 1" round tubing. To install simply snap into place.

Part #
1912-BK

## Adhesive Glide Strips

### Sections

- **Material:** HDPE
- Smooth gliding action after application.
- Used under glass tops where sliding action is needed, in heavy wood drawers where nailing is difficult and in metal drawers when drilling is to be avoided.

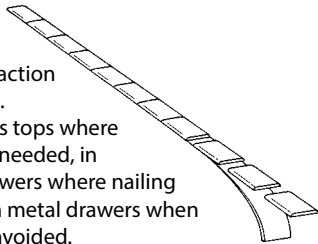

Part #	Color
R46-450OW	Off White
R46-4046BK	Black
R46-4023OW	Off White
R46-4023BK	Black

- Material is supplied in 12" sections.
- Glides can be peeled off one at a time.

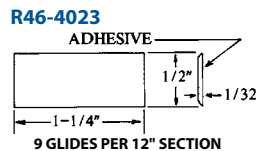
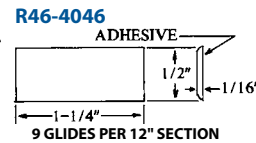
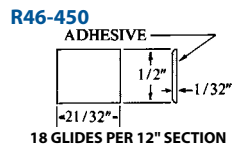

## Break-Away Plastic Furniture Wedge

**Material:** Polystyrene

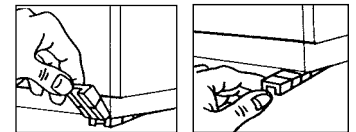
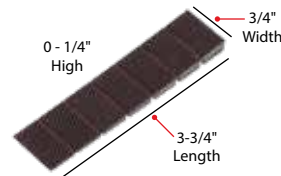

Part #	Color
58-076-400	Dk. Brown

## Continuous Coil

- **Material:** HDPE
- One piece glide strip.
- Coil may be cut to desired length.

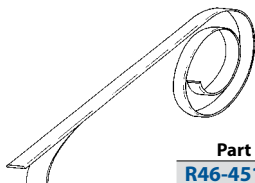

Part #	Color
R46-451OW	Off White

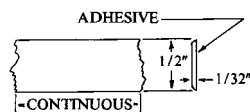

## Floor Glide And Protector



- **Material:** Polyethylene
- Staple to underside of cabinets or furniture
- Prevents damage to cabinets during handling and transportation.
- 1/4" (60mm) of clearance between cabinet and floor

Part #	Size	Color
R32-737	1-1/2"	Natural

# Hooded Die-Cast Twin Wheels



## Pac-50

### 2" Diameter Wheels

**Material:** Zinc Die-Cast Hood  
w/Nylon Wheel



Shown with  
Chrome  
#1 Top Plate



Shown with  
Antique Brass  
#2 Gripneck  
& Brake

### Swivel Without Brake

Part #	Hood Finish
PAC-50-*-CHR	Chrome
PAC-50-*-AB	Antique Brass

*\* Please use chart on right  
determine required top portion*

### Swivel With Brake

Part #	Hood Finish
PAC-50-*-CHR-BRK	Chrome
PAC-50-*-AB-BRK	Antique Brass

### Top Portions Available

<p><b>#(1)</b> Top Plate 3/16" Hole Dia. 1" sq.</p>	<p><b>#(2)</b> 5/16" x 1-1/2" Long Gripneck Comes with Socket for Wood</p>	<p><b>#(3)</b> 1/4-20 x 1/2" Thread <b>#(4)</b> 5/16-18 x 1-1/2" Thread <b>#(5)</b> 5/16-18 x 1" Thread</p>
<p><b>#(7)</b> 3/8-16 x 3/4" Thread</p>	<p><b>#(8)</b> 3/8-16 x 1" Thread <b>#(9)</b> 3/8-16 x 1-1/2" Thread</p>	<p><b>#(10)</b> 3/8" x 1" Friction <b>#(11)</b> 7/16" x 7/8" Friction <b>#(12)</b> 7/16" x 1-7/16" Friction</p>

### CASTER SPECIFICATIONS:

	Pac-50 (2")	Pac-60 (2-3/8")
Mounting Height With Top Plate	2-11/16"	3-1/16"
Mounting Height with Threaded Stem	2-1/2"	2-7/8"
Mounting Height with Friction Ring Stem	2-3/8"	2-3/4"
Swivel Radius Without Brake	1-3/4"	2-3/16"
Swivel Radius With Brake	2-7/16"	N/A

## Pac-60

### 2-3/8" Diameter Wheels

**Material:** Zinc Die-Cast Hood  
w/Nylon Wheel



Shown with  
Chrome  
#7 Thread



Shown with  
Antique Brass  
#10 Friction  
Stem

### Swivel Without Brake

Part #	Hood Finish
PAC-60-*-CHR	Chrome
PAC-60-*-AB	Antique Brass

*\* Please use chart below to  
determine required top portion*

### Top Portions Available

<p><b>#(1)</b> Top Plate 3/16" Hole Dia. 1" sq.</p>	<p><b>#(2)</b> 5/16" x 1-1/2" Long Gripneck Comes with Socket for Wood</p>	<p><b>#(3)</b> 5/16-18 x 1/2" Thread <b>#(4)</b> 5/16-18 x 7/8" Thread</p>	<p><b>#(5)</b> 5/16-18 x 1-1/4" Thread</p>	<p><b>#(7)</b> 3/8-16 x 3/4" Thread <b>#(8)</b> 3/8-16 x 1-1/2" Thread</p>	<p><b>#(9)</b> 3/8" x 1" Friction <b>#(10)</b> 7/16" x 7/8" Friction <b>#(11)</b> 7/16" x 1-7/16" Friction</p>
---	--	--	--	--	--



## Samson

### 2" Diameter Wheels

**Material:** Black Nylon w/Zinc Finish Stem/Plate

- 75 lb. Load Capacity, for Light Duty Mobility
- Variety of Mounting Options Available

Part #	Brake Option	Hood Finish
<b>SAMS-*-BK</b>	w/o Brake	Black
<b>SAMS-*-BK-BRK</b>	w/Brake	Black



Shown with #1 Top Plate & Brake



Shown with #14 Friction Stem

*\* Please use chart below to determine required top portion*

## Hercules

### 2-3/8" Diameter Wheels

**Material:** Black Nylon w/Zinc Finish Stem/Plate

- 100 lb. Load Capacity, for Light-Medium Duty Mobility
- Variety of Mounting Options Available

Part #	Brake Option	Hood Finish
<b>HERC-*-BK</b>	w/o Brake	Black
<b>HERC-*-BK-BRK</b>	w/Brake	Black



Shown with #10 Thread & Brake









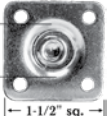

Shown with #2 Gripneck

*\* Please use chart below to determine required top portion*



CASTER SPECIFICATIONS:	Samson (2")	Hercules (2-3/8")
Mounting Height With Top Plate	2-9/16"	3"
Mounting Height with Threaded & Friction Ring Stems	2-5/16"	2-11/16"
Swivel Radius Without Brake	1-3/4"	2-3/16"
Swivel Radius With Brake	2-1/8"	2-7/8"

### Top Portions Available

<p><b>#(1)</b> Top Plate 3/16" Hole Dia. </p>	<p><b>#(2)</b> 5/16" x 1-1/2" Long Gripneck Comes with Socket for Wood </p>	<p><b>#(3)</b> 1/4-20 x 1/2" Thread <b>#(4)</b> 1/4-20 x 1" Thread </p>	<p><b>#(6)</b> 5/16-18 x 3/4" Thread <b>#(7)</b> 5/16-18 x 1" Thread </p>
<p><b>#(10)</b> 3/8-16 x 1" Thread </p>	<p><b>#(11)</b> 3/8" x 1" Friction <b>#(13)</b> 7/16" x 7/8" Friction <b>#(14)</b> 7/16" x 1-3/8" Friction </p>	<p><b>#(16)</b> Fits 3/4" Board <b>U-CLIP</b> </p>	

**SEE PAGE E-20 FOR METAL THREADED INSERTS AND PAGES E-18~19 FOR METAL THREADED STARTYPES**



## 2" Diameter Wheels

**Material:** Black Nylon Body, Soft Polyurethane Tread with Zinc Finish Stem/Plate

- 110 lb. Load Capacity
- Multiple Mounting Options Available

Part #	Brake Option
SM-50-1-BK	-
SM-50-1-BK-BRK	Brake
SM-50-13-BK	-
SM-50-13-BK-BRK	Brake
SM-50-6-BK	-
SM-50-6-BK-BRK	Brake



Shown with #13 Friction Stem



Shown with #13 Friction Stem & Brake

*\* Please use chart below to determine required top portion*

## 2-3/8" Diameter Wheels

**Material:** Black Nylon Body, Polyurethane Tread with Zinc Finish Stem/Plate

- 132 lb. Load Capacity
- Multiple Mounting Options Available



Shown with #6 Thread



Shown with #6 Thread & Brake



Shown with #1 Top Plate



Shown with #1 Top Plate & Brake

*\* Please use chart below to determine required top portion*

Part #	Brake Option
HC-60-1-BK	-
HC-60-1-BK-BRK	Brake
HC-60-13-BK	-
HC-60-13-BK-BRK	Brake
HC-60-6-BK	-
HC-60-6-BK-BRK	Brake

**Top Portions Available**

<p><b>#(1)</b> Top Plate 3/16" Hole Dia. 1" sq. 1-1/2" sq.</p>	<p><b>#(6)</b> 5/16-18 x 3/4" Threaded Stem 1-1/2"</p>	<p><b>#(13)</b> 7/16" x 7/8" Friction Ring Stem 1-1/2"</p>
--	--	--

**CASTER SPECIFICATIONS:**

	2"	2-3/8"
Mounting Height with Top Plate:	2-9/16"	3"
Mounting Height w/ Threaded & Friction Ring Stems:	2-5/16"	2-11/16"
Swivel Radius without Brake:	1-3/4"	2-3/16"
Swivel Radius with Brake:	2-1/8"	2-7/8"

SEE PAGE E-20 FOR METAL THREADED INSERTS AND PAGES E-18-19 FOR METAL THREADED STARTYPES

# Black Non-Hooded Nylon Twin Wheels



## Mity Mite Series

- All nylon construction provides high load ratings and durability.
- Sleek and contemporary rounded wheel design.
- Riveted axle for positive wheel retention, (4" & 5").



**IDEALLY SUITED FOR:**  
STORE FIXTURES, DISPLAYS, MEDICAL EQUIPMENT,  
UTILITY CARTS, FURNITURE AND OFFICE EQUIPMENT.

### Swivel Top Plate Models:

#### Without Brake

Wheel Diameter	Part #	Load Capacity	Mounting Height	Swivel Radius	Top Portion	Pcs. Per Carton
1-1/2"	<a href="#">MML2-1</a>	65 lbs.	2"	1-1/4"	Top Plate: 1-1/2" Sq. Mounting Hole: 1" x 1" Spacing	120
2"	<a href="#">MML3-1</a>	88 lbs.	2-7/16"	1-3/4"		120
3"	<a href="#">MM35-1</a>	150 lbs.	3-7/16"	2-1/2"		120
4"	<a href="#">MML4-1</a>	175 lbs.	4-5/8"	3-5/8"	Top Plate: 2-5/8" x 3-3/4" Mounting Hole: 1-3/4" x 2-3/4 to 3" Spacing	40
5"	<a href="#">MML5-1</a>	180 lbs.	5-5/8"	4-1/2"		20

#### With Brake

Wheel Diameter	Part #	Load Capacity	Mounting Height	Swivel Radius	Top Portion	Pcs. Per Carton
2"	<a href="#">MML3BR-1</a>	88 lbs.	2-7/16"	2-1/8"	Top Plate: 1-1/2" Sq.	120
3"	<a href="#">MM35BR-1</a>	150 lbs.	3-7/16"	3-1/8"	Mounting Hole: 1" x 1" Spacing	120
4"	<a href="#">MML4BR-1</a>	175 lbs.	4-5/8"	4-1/2"	Top Plate: 2-5/8" x 3-3/4"	40
5"	<a href="#">MML5BR-1</a>	180 lbs.	5-5/8"	5-1/8"	Mounting Hole: 1-3/4" x 2-3/4 to 3" Spacing	20

### Threaded Stem Models:

#### Without Brake

Wheel Diameter	Part #	Load Capacity	Mounting Height	Swivel Radius	Top Portion	Pcs. Per Carton
1-1/2"	<a href="#">MML2-6</a>	50 lbs.	2"	1-1/2"	5/16-18 x 3/4" Long	120
2"	<a href="#">MML3-6</a>	88 lbs.	2-1/4"	1-3/4"	5/16-18 x 3/4" Long	120
3"	<a href="#">MM35-10</a>	150 lbs.	3-1/4"	2-1/2"	3/8-16 x 1" Long	120
4"	<a href="#">MML4-10</a>	175 lbs.	4-3/8"	3-5/8"	3/8-16 x 1" Long	40
5"	<a href="#">MML5-18</a>	180 lbs.	5-7/16"	4-1/2"	1/2-13 x 1" Long	20

#### With Brake

Wheel Diameter	Part #	Load Capacity	Mounting Height	Swivel Radius	Top Portion	Pcs. Per Carton
2"	<a href="#">MML3BR-6</a>	88 lbs.	2-1/4"	2-1/8"	5/16-18 x 3/4" Long	120
3"	<a href="#">MM35BR-10</a>	150 lbs.	3-1/4"	3-1/8"	3/8-16 x 1" Long	120
4"	<a href="#">MML4BR-10</a>	175 lbs.	4-3/8"	4-1/2"	3/8-16 x 1" Long	40
5"	<a href="#">MML5BR-18</a>	180 lbs.	5-7/16"	5-1/8"	1/2-13 x 1" Long	20

### Friction Ring Stem Models:

Wheel Diameter	Part #	Load Capacity	Mounting Height	Swivel Radius	Top Portion	Pcs. Per Carton
2"	<a href="#">MML3-13</a>	88 lbs.	2-1/4"	1-3/4"	7/16 x 7/8" Friction Ring Stem	120
	<a href="#">MML3BR-13</a>			2-1/8"	7/16 x 7/8" Friction Ring Stem w/ Brake	

**SEE PAGE E-20 FOR METAL THREADED INSERTS AND PAGES E-18~19 FOR METAL THREADED STARTYPES**  
**OTHER TOP FITTINGS AVAILABLE, PLEASE INQUIRE**

# Black Non-Hooded Diecast Twin Wheels



- Rounded nylon wheels with zinc diecast body provides a greater load rating than typical 2" twin wheels.
- Exceeds ANSI/BIFMA test requirements.



**IDEALLY SUITED FOR:**  
STORE FIXTURES, DISPLAYS, ELECTRONIC EQUIPMENT,  
MEDICAL EQUIPMENT AND OFFICE EQUIPMENT.

## Swivel Top Plate Models:

Wheel Diameter	Part #	Load Capacity	Mounting Height	Swivel Radius	Top Portion	Mounting Holes	Pcs. Per Carton
2"	MM3-1 MM3BR-1	110 lbs.	2-11/32"	1-3/4" 2-1/8"	1-1/2" Square Top Plate 1-1/2" Square Top Plate w/ Brake	1" x 1" Spacing	120

## Threaded Stem Models:

Wheel Diameter	Part #	Load Capacity	Mounting Height	Swivel Radius	Top Portion	Pcs. Per Carton
2"	MM3-6 MM3-10	110 lbs.	2-3/16"	1-3/4"	5/16-18 x 3/4" Long 3/8-16 x 1" Long	120
2"	MM3BR-6 MM3BR-10	110 lbs.	2-3/16"	2-1/8"	5/16-18 x 3/4" Long w/ Brake 3/8-16 x 1" Long w/ Brake	120

## Friction Ring Stem Models:

Wheel Diameter	Part #	Load Capacity	Mounting Height	Swivel Radius	Top Portion	Pcs. Per Carton
2"	MM3-13 MM3BR-13	110 lbs.	2-3/16"	1-3/4" 2-1/8"	7/16" x 7/8" Friction Ring Stem 7/16" x 7/8" Friction Ring Stem w/ Brake	120



- 100% Nylon body construction
- Perfect for office chair replacements
- Meets or exceeds ANSI/BIFMA specifications
- Set includes 5 casters



Wheel Diameter	Part #	Load Capacity	Mounting Height	Swivel Radius	Top Portion
2"	EWTC-50-BK	250 lbs. per set of 5	2-3/16"	1-3/4"	7/16" x 7/8" Friction Ring Stem 38mm Euro Style Neck Diameter

SEE PAGE E-20 FOR METAL THREADED INSERTS AND PAGES E-18~19 FOR METAL THREADED STARTYPES  
OTHER TOP FITTINGS AVAILABLE, PLEASE INQUIRE



## 1-1/2" Diameter x 2" Wide (Nominal)

### **IDEALLY SUITED FOR:**

**MEDICAL EQUIPMENT, STORE FIXTURES, DISPLAYS,  
OFFICE EQUIPMENT, AND ELECTRONIC EQUIPMENT.**

- Housing & wheels are 1<sup>st</sup> class polyamide with special soft tread of polyurethane which provide a cushioned ride and quiet operation.
- Low profile and easy to conceal.
- High load rating provides great strength at an affordable cost.



With Brake



With Brake

#### Top Plate Models:

Wheel Diameter	Part #	Load Capacity	Mounting Height	Swivel Radius	Description
1-1/2" x 2" Wide	<b>MMW2-1</b>	90 lbs.	1-3/4"	1-11/16"	1-1/2" Dia. Mity Mite Wide Twinwheel. 1-1/2" Sq. Top Plate w/1" Sq. Mounting Hole - Black
	<b>MMW2BR-1</b>	90 lbs.	1-3/4"	1-11/16"	1-1/2" Dia. Mity Mite Wide Twinwheel w/Brake. 1-1/2" Sq. Top Plate w/1" Sq. Mounting Hole - Black

#### Threaded Stem Models:

Wheel Diameter	Part #	Load Capacity	Mounting Height	Swivel Radius	Description
1-1/2" x 2" Wide	<b>MMW2-6</b>	90 lbs.	1-5/8"	1-11/16"	1-1/2" Dia. Mity Mite Wide Twinwheel. 5/16-18 x 5/8" Long Threaded Stem - Black
	<b>MMW2BR-6</b>	90 lbs.	1-5/8"	1-11/16"	1-1/2" Dia. Mity Mite Wide Twinwheel w/Brake. 5/16-18 x 5/8" Long Threaded Stem w/Brake - Black

### **...AND IF YOU NEED A HEAVIER LOAD CAPACITY**



With Brake

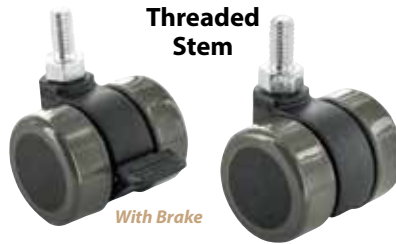

With Brake



With Brake

#### Top Plate Models:

Wheel Diameter	Part #	Load Capacity	Mounting Height	Swivel Radius	Description
1-1/2" x 2" Wide	<b>MMW2X-1</b>	150 lbs.	2.05"	1.85"	1-1/2" Dia. Mity Mite Wide Twinwheel. 1-1/2" Sq. Top Plate w/1" Sq. Mounting Hole. Black housing & wheels with a grey soft polyurethane tread.
	<b>MMW2XBR-1</b>	150 lbs.	2.05"	1.85"	1-1/2" Dia. Mity Mite Wide Twinwheel w/Brake. 1-1/2" Sq. Top Plate w/1" Sq. Mounting Hole. Black housing & wheels with a grey soft polyurethane tread.

#### Threaded Stem Models:

Wheel Diameter	Part #	Load Capacity	Mounting Height	Swivel Radius	Description
1-1/2" x 2" Wide	<b>MMW2X-6</b>	150 lbs.	1-7/8"	1.85"	1-1/2" Dia. Mity Mite Wide Twinwheel. 5/16-18 x 5/8" Long Threaded Stem. Black housing & wheels with a grey soft polyurethane tread.
	<b>MMW2XBR-6</b>	150 lbs.	1-7/8"	1.85"	1-1/2" Dia. Mity Mite Wide Twinwheel w/Brake. 5/16-18 x 5/8" Long Threaded Stem w/Brake. Black housing & wheels with a grey soft polyurethane tread.

#### "No-Noise" Friction Ring Stem Models:

Wheel Diameter	Part #	Load Capacity	Mounting Height	Swivel Radius	Description
1-1/2" x 2" Wide	<b>MMW2X-13</b>	150 lbs.	1-3/4"	1.85"	1-1/2" Dia. Mity Mite Wide Twinwheel. 7/16 x 3/4" "No-Noise" Friction Ring Stem. Black housing & wheels with a grey soft polyurethane tread.
	<b>MMW2XBR-13</b>	150 lbs.	1-7/8"	1.85"	1-1/2" Dia. Mity Mite Wide Twinwheel w/Brake. 7/16 x 3/4" "No-Noise" Friction Ring Stem. Black housing & wheels with a grey soft polyurethane tread.

**SEE PAGE E-20 FOR METAL THREADED INSERTS AND PAGES E-18~19 FOR METAL THREADED STARTYPES  
OTHER TOP FITTINGS AVAILABLE, PLEASE INQUIRE**





## Softech



- Soft tread gray thermoplastic elastomer twin wheel provides a quiet cushioned ride.
- This 2-toned gray twin wheel provides an attractive and stylish look while supporting a heavy load.
- Ideal for all hospital/medical equipment and furniture or wherever you want style and strength.

### Without Brake

Wheel Diameter	Part #	Load Capacity	Mounting Height	Swivel Radius	Top Portion	Mounting Hole Spacing	Pcs. Per Carton
2"	MMI2-10	75 lbs.	2-1/4"	1-13/16"	3/8-16 x 1" Threaded Stem	-	100
	MMI2-13		2-1/4"		7/16 x 7/8" Friction Ring Stem	-	
	MMI2-1		2-3/8"		1-1/2" Square Top Plate	1" x 1"	
2-3/8"	MMI28-10	100 lbs.	2-5/8"	2-1/16"	3/8-16 x 1" Threaded Stem	-	100
	MMI28-13		2-5/8"		7/16 x 7/8" Friction Ring Stem	-	
	MMI28-1		2-3/4"		1-1/2" Square Top Plate	1" x 1"	

### With Brake

Wheel Diameter	Part #	Load Capacity	Mounting Height	Swivel Radius	Top Portion	Mounting Hole Spacing	Pcs. Per Carton
2"	MMI2BR-10	75 lbs.	2-1/4"	2-3/8"	3/8-16 x 1" Threaded Stem	-	100
	MMI2BR-13		2-1/4"		7/16 x 7/8" Friction Ring Stem	-	
	MMI2BR-1		2-3/8"		1-1/2" Square Top Plate	1" x 1"	
2-3/8"	MMI28BR-10	100 lbs.	2-5/8"	2-1/2"	3/8-16 x 1" Threaded Stem	-	100
	MMI28BR-13		2-5/8"		7/16 x 7/8" Friction Ring Stem	-	
	MMI28BR-1		2-3/4"		1-1/2" Square Top Plate	1" x 1"	



## Total Locking Soft Ride



- Gray soft polyurethane tread with nylon construction provides a quiet and cushioned ride.
- Total locking brake option will securely lock the wheel and top portion when engaged.
- Sleek design and superior mobility rating - Best on the market!
- Ideal for electronic equipment, medical equipment, store fixtures and furniture.



### Without Brake

Wheel Diameter	Part #	Load Capacity	Mounting Height	Swivel Radius	Top Portion	Mounting Hole Spacing	Pcs. Per Carton
3"	MMI35-1	175 lbs.	3-7/8"	2-1/4"	2-3/4" x 2-5/16" Top Plate	1-21/32" x 2-5/32"	120
	MMI35-18		3-9/16"		1/2"-13 x 1" Long Threaded Stem	-	
4"	MMI4-1	220 lbs.	5-1/4"	3-1/16"	2-3/4" x 2-5/16" Top Plate	1-3/4" x 2-29/32"	120
	MMI4-18		5"		1/2"-13 x 1" Long Threaded Stem	-	

### With Brake

Wheel Diameter	Part #	Load Capacity	Mounting Height	Swivel Radius	Top Portion	Mounting Hole Spacing	Pcs. Per Carton
3"	MMI35BR-1	175 lbs.	3-7/8"	2-7/8"	2-3/4" x 2-5/16" Top Plate	1-21/32" x 2-5/32"	120
	MMI35BR-18		3-9/16"		1/2"-13 x 1" Long Threaded Stem	-	
4"	MMI4BR-1	220 lbs.	5-1/4"	3-3/4"	2-3/4" x 2-5/16" Top Plate	1-3/4" x 2-29/32"	120
	MMI4BR-18		5"		1/2"-13 x 1" Long Threaded Stem	-	

**SEE PAGE E-20 FOR METAL THREADED INSERTS AND PAGES E-18~19 FOR METAL THREADED STARTYPES  
OTHER TOP FITTINGS AVAILABLE, PLEASE INQUIRE**

## The X-Caster

### 2" Dual Wheels



- Designed specifically for the retail display industry
- Strongest composite caster on the market
- The X-Caster has a higher load capacity than twin wheel casters. High load capacity at a LOW price.
- Wide variety of top fittings and wheel materials available
- Exclusively from the Jacob Holtz Company



Top Plate

205-2XPU-04-WB



1" Long Threaded Stem

205-2XPP-27-WB



1-1/2" Long Threaded Stem

205-2XPU-24



Friction Ring Stem

205-2XPU-61

Wheel Dia.	Wheel Material	Tread Width	Mounting Height	Swivel Radius	Load Capacity Per Caster	Top Fitting	Swivel Part #	Swivel w/Brake Part #
2"	Black Polypropylene	3/4" x 2"	2-45/64"	1-27/32"	150 lbs.	1-1/4" x 2" Top Plate	205-2XPP-04	205-2XPP-04-WB
2"	Black Polypropylene	3/4" x 2"	2-45/64"	1-27/32"	150 lbs.	5/16-18 x 1-1/2" Threaded Stem	205-2XPP-24	205-2XPP-24-WB
2"	Black Polypropylene	3/4" x 2"	2-45/64"	1-27/32"	150 lbs.	3/8-16 x 1" Threaded Stem	205-2XPP-27	205-2XPP-27-WB
2"	Black Polypropylene	3/4" x 2"	2-45/64"	1-27/32"	150 lbs.	7/16" x 1-1/2" Friction Ring Stem	205-2XPP-61	205-2XPP-61-WB
2"	Grey Polyurethane on Black Polypropylene Core	3/4" x 2"	2-45/64"	1-27/32"	150 lbs.	1-1/4" x 2" Top Plate	205-2XPU-04	205-2XPU-04-WB
2"	Grey Polyurethane on Black Polypropylene Core	3/4" x 2"	2-45/64"	1-27/32"	150 lbs.	5/16-18 x 1-1/2" Threaded Stem	205-2XPU-24	205-2XPU-24-WB
2"	Grey Polyurethane on Black Polypropylene Core	3/4" x 2"	2-45/64"	1-27/32"	150 lbs.	3/8-16 x 1" Threaded Stem	205-2XPU-27	205-2XPU-27-WB
2"	Grey Polyurethane on Black Polypropylene Core	3/4" x 2"	2-45/64"	1-27/32"	150 lbs.	7/16" x 1-1/2" Friction Ring Stem	205-2XPU-61	205-2XPU-61-WB

## High Impact Styrene Wheel Casters

With 5/16" x 1-1/2" Long Socket Stems

- Brass
- Dependable
- Long Lasting
- Sturdy
- Economical
- Black Wheels
- Supplied With Metal Sockets



With Top Plate

- Black
- Dupont Nylon Thrust Bearing For Silent Swivel Action

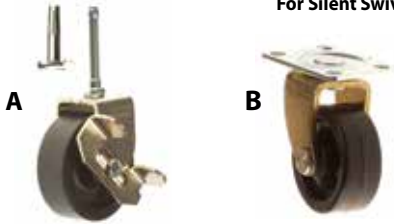

Part #	Finish	Description
A <b>231-71-2WB</b>	Brass	2" Dia. x 3/4" Wide w/Brake 45 lbs. Load Capacity
B <b>161-71-T.P.</b>	Brass w/ Black Wheel	1-5/8" Dia. x 5/8" Wide 35 lbs. Load Capacity

## Dual Wheel Appliance Caster

Designed for rolling refrigerators, dishwashers and other heavy appliances in the home or office.

### Specifications:

Wheel Size: 7/8" Dia. x 1-1/2" Wide

Rig Dimensions: 1-3/4"L x 1-1/2"W x 1-1/8"H

Color: White Only

Material: Polypropylene

Load Rating: 800 lbs. per set of 4

Mounting Height: 1-5/16"

Top Portion: 5/16-18 x 7/8" Long Threaded Stem w/Hex Nut

Rig: Heavy Duty Zinc Plated Steel



#APL78

## Dual Wheel Casters

- 2" Dia. x 7/8" Wide
- Load Capacity: 160 lbs. to 200 lbs.
- Zinc Finish
- Ruberex & Polypropylene Wheels

### EW459-2

Bore Dimension:

29/64" Dia. x 1-9/16" Deep



### EP659-2

Top Plate: 2-9/16" x 3-5/8"

Bolt Holes: 1-3/4" x 2-7/8" to 3"



Part #	Wheel Material	Load Capacity Per Caster	Mounting Height
<b>EW459-2</b>	Ruberex	160 lbs.	2-23/32"
<b>EP659-2</b>	Polypropylene	200 lbs.	2-27/32"

## Solid Brass Casters

### Square Cup



Wheel Diameter: 1.46"  
Cup I.D.: Tapers from 1-1/8" to 1"  
Cup Height is 1.63"



Part #	Finish
<b>BSC-48-BC</b>	Brushed Chrome

## Low Profile Spring Cup Caster

Ideal For: Display counters, T.V. stands, furniture, kitchen counters and islands.



- Super Load Capacity: 165 lbs. per caster.
- Recessed Mounting Design: Drill a 3-3/8" diameter hole with a depth of 3/4".
- Easy Installation: Push the spring cup caster into the hole until it is flush with mounting flange.
- Metal teeth mesh with the wood, particle board or other material. For extra security, there are 3 holes for screws.



Caster is recessed

#LPSC-75N

### Specifications:

Overall Height: 1.78"

Wheel Material: Nylon

Overall Rim Diameter: 4-3/32"

Insert Dimension: 3/4"

Turning Radius: 360°

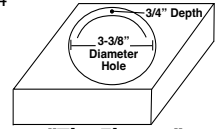
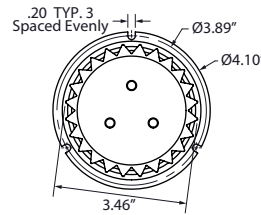

"The Floater"

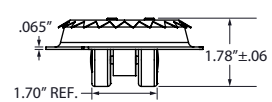
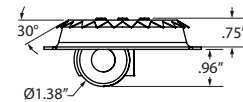

## Recessed Swivel Caster

- Material: Black Nylon
- Load Capacity: 110 lbs. per caster
- Wheel Diameter: 1-3/16"
- Drill Hole Size: 2-37/64"
- Cap Size: 2-1/4"



#RSC-65

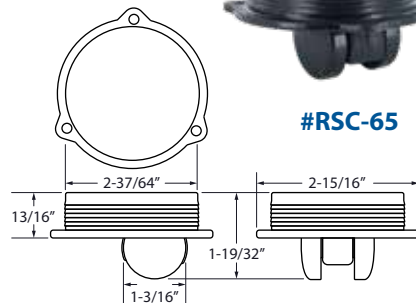

**1-1/2" & 2" Hooded**  
**Brite Chrome or Antique Brass Finish • 4 Top Portions Available**

**Medallion**



Shown:  
Brite Chrome



Shown:  
1/2" TPR Wheel

Wheel Diameter	Part #	Finish	Load Capacity Set Of 4	Mounting Height	Top Portion	Sets Per Carton
1-1/2"	<b>MEDALLION-40CHR</b>	Brite Chrome	300 lbs.	2-1/4"	2" x 1-3/16"	25
	<b>MEDALLION-40BRS</b>	Antique Brass		2-1/4"	Rectangular Top Plate, with 1-5/8" x 7/8" Bolt Holes	
2"	<b>MEDALLION-CHR</b>	Brite Chrome	400 lbs.	2-5/8"	1-1/2" Square Top Plate, 1-1/8" Hole Spacing, 13/64" Hole Diameter	
	<b>MEDALLION-BRS</b>	Antique Brass		2-5/8"		
1-1/2"	<b>MEDALLION-T-40CHR</b>	Grey/Black TPR Ball w/ Chrome Hood	352 lbs.	2-1/4"	25	
2"	<b>MEDALLION-T-CHR</b>		528 lbs.	2-3/8"		

**Neptune**



Shown:  
Antique Brass

Wheel Diameter	Part #	Finish	Load Capacity Set Of 4	Mounting Height	Top Portion	Sets Per Carton
1-1/2"	<b>NEPTUNE-40CHR</b>	Brite Chrome	300 lbs.	2-3/16"	7/16" x 1-3/8" Long Friction Ring Stem	25
	<b>NEPTUNE-40BRS</b>	Antique Brass		2-3/16"		
2"	<b>NEPTUNE-CHR</b>	Brite Chrome	400 lbs.	2-1/2"		
	<b>NEPTUNE-BRS</b>	Antique Brass		2-1/2"		

**Regency**



Shown:  
Antique Brass

Wheel Diameter	Part #	Finish	Load Capacity Set Of 4	Mounting Height	Top Portion	Sets Per Carton
1-1/2"	<b>REGENCY-40CHR</b>	Brite Chrome	300 lbs.	2-1/8"	5/16" x 1-1/2" Long Gripneck Stem With Metal Sockets	25
	<b>REGENCY-40BRS</b>	Antique Brass		2-1/8"		
2"	<b>REGENCY-CHR</b>	Brite Chrome	400 lbs.	2-1/2"		
	<b>REGENCY-BRS</b>	Antique Brass		2-1/2"		

**Magnum**



Shown: 2"  
Brite Chrome

Wheel Diameter	Part #	Finish	Load Capacity Set Of 4	Mounting Height	Top Portion	Sets Per Carton
1-1/2"	<b>MAGNUM-40CHR</b>	Brite Chrome	300 lbs.	2-1/4"	5/16-18 x 1" Long Threaded Stem	25
	<b>MAGNUM-40BRS</b>	Antique Brass		2-1/4"		
2"	<b>MAGNUM-CHR</b>	Brite Chrome	400 lbs.	2-1/2"		
	<b>MAGNUM-BRS</b>	Antique Brass		2-1/2"		



**Satellite Series Metal Ball Casters**

**50MM Metal**

**Brite Brass, Brite Chrome, Satin Chrome or Windsor Antique Finish • 3 Top Portions Available**

**Malibu**



Shown:  
Brite Chrome

Part #	Finish	Load Capacity Per Pc.	Mounting Height	Top Portion
<b>MALIBU-BB</b>	Brite Brass	75 lbs.	2-3/16"	5/16" x 1-1/2" Long Gripneck Stem Supplied With Gripneck Sleeves
<b>MALIBU-BC</b>	Brite Chrome			
<b>MALIBU-SC</b>	Satin Chrome			
<b>MALIBU-WA</b>	Windsor Antique			

**Madrid**



Shown:  
Windsor Antique

Part #	Finish	Load Capacity Per Pc.	Mounting Height	Top Portion
<b>MADRID-BB</b>	Brite Brass	75 lbs.	2-1/2"	1-1/2"
<b>MADRID-BC</b>	Brite Chrome			Square Top Plate, with 1" x 1" Bolt Holes
<b>MADRID-SC</b>	Satin Chrome			
<b>MADRID-WA</b>	Windsor Antique			

**Milan**



Shown:  
Brite Brass

Part #	Finish	Load Capacity Per Pc.	Mounting Height	Top Portion
<b>MILAN-BB</b>	Brite Brass	75 lbs.	2-5/16"	5/16" x 1" Long Threaded Stem
<b>MILAN-BC</b>	Brite Chrome			
<b>MILAN-SC</b>	Satin Chrome			
<b>MILAN-WA</b>	Windsor Antique			

# Ball Casters *Combine the Low-Profile, Omni-Directional and Load Capacity benefits of Ball Transfers with the Utility of Traditional Casters*

Applications include Retail or Point of Sale Displays, Furniture, Computer or Restaurant Equipment, Warehouse Racking or the Hospitality needs, almost anywhere you will need full mobility

**EZ Swivel Radius**

**Super Low Profile**



## 3 Types



**Flange**



**Threaded Stud Mounted**



**Drop-In**

## Ball Options

**White Nylon**



**Non-marring**

**Carbon Steel**



**Strength with Cost Effectiveness**

**Stainless Steel**



**Corrosion Resistant**

**Phenolic**



**Special Order Please Inquire**

## Ball Up

## Ball Down

# VS



Traditionally used on conveyor systems, load rating is highest in this position



A low profile option with omni-directional movement

*Carbon Steel is standard for housing material but Stainless Steel with Stainless Steel ball is available - please inquire*

## Flange Mounted Casters

### Round Flange

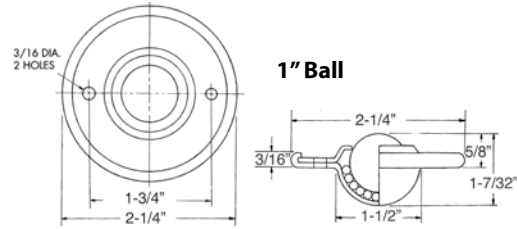
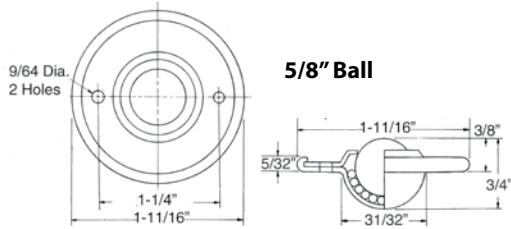

Part #	Ball Material	Housing Material	Ball Size	Load Rating	
				Ball Up	Ball Down
<b>HBCCRF-20</b>	Carbon Steel	Carbon Steel	5/8"	20 lbs.	10 lbs.
<b>HNBCRF-20</b>	Nylon	Carbon Steel	5/8"	20 lbs.	10 lbs.
<b>HSSBCRF-20</b>	Stainless Steel	Carbon Steel	5/8"	20 lbs.	10 lbs.
<b>HBCCRF-32</b>	Carbon Steel	Carbon Steel	1"	75 lbs.	35 lbs.
<b>HNBCRF-32</b>	Nylon	Carbon Steel	1"	75 lbs.	35 lbs.
<b>HSSBCRF-32</b>	Stainless Steel	Carbon Steel	1"	75 lbs.	35 lbs.
<b>HBCCRF-48</b>	Carbon Steel	Carbon Steel	1-1/2"	200 lbs.	100 lbs.
<b>HNBCRF-48</b>	Nylon	Carbon Steel	1-1/2"	200 lbs.	100 lbs.
<b>HSSBCRF-48</b>	Stainless Steel	Carbon Steel	1-1/2"	200 lbs.	100 lbs.

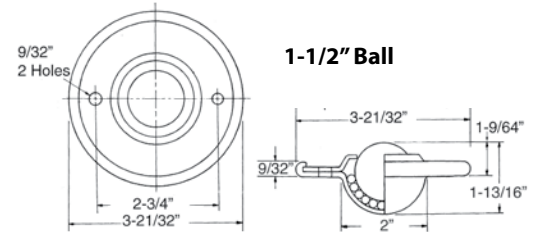

### Oblong Flange

Part #	Ball Material	Housing Material	Ball Size	Load Rating	
				Ball Up	Ball Down
<b>HBCOF-32</b>	Carbon Steel	Carbon Steel	1"	75 lbs.	35 lbs.
<b>HNBCOF-32</b>	Nylon	Carbon Steel	1"	75 lbs.	35 lbs.
<b>HSSBCOF-32</b>	Stainless Steel	Carbon Steel	1"	75 lbs.	35 lbs.

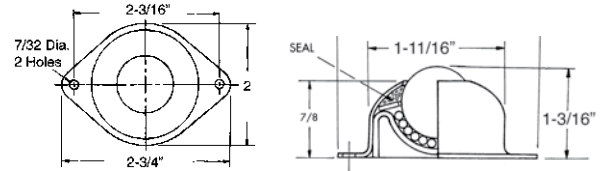

### Low Profile Oblong Flange

Part #	Ball Material	Housing Material	Ball Size	Load Rating	
				Ball Up	Ball Down
<b>HBLPOF-32</b>	Carbon Steel	Carbon Steel	1"	75 lbs.	35 lbs.
<b>HNBLPOF-32</b>	Nylon	Carbon Steel	1"	75 lbs.	35 lbs.
<b>HSSBLPOF-32</b>	Stainless Steel	Carbon Steel	1"	75 lbs.	35 lbs.

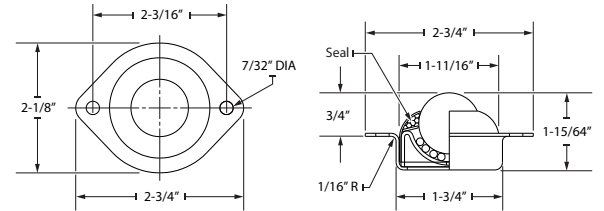

### Square Flange

Part #	Ball Material	Housing Material	Ball Size	Load Rating	
				Ball Up	Ball Down
<b>HBCSF-48</b>	Carbon Steel	Carbon Steel	1-1/2"	250 lbs.	125 lbs.
<b>HNBCSF-48</b>	Nylon	Carbon Steel	1-1/2"	250 lbs.	125 lbs.
<b>HSSBCSF-48</b>	Stainless Steel	Carbon Steel	1-1/2"	250 lbs.	125 lbs.

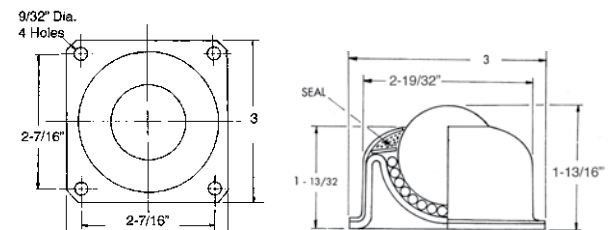

# Ball Caster/Transfers

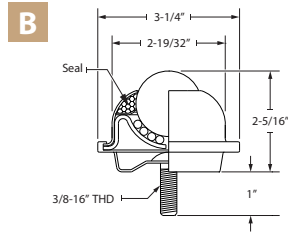
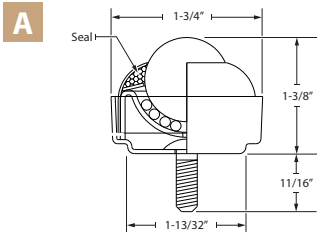

\*Available w/noise reducing cushion. Please Inquire.

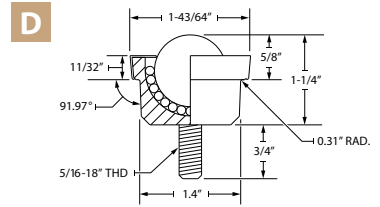
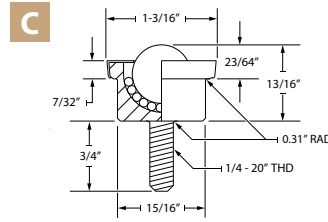

\*Brake option available. Please Inquire.



## Threaded Stud Mounted Casters

	Part #	Ball Material	Housing Material	Ball Size	Load Rating		Thread Size
					Ball Up	Ball Down	
A	HBSBT32-4	Carbon Steel	Carbon Steel	1"	75 lbs.	35 lbs.	1/4-20 x 1"
	HNBSBT32-4	Nylon	Carbon Steel	1"	75 lbs.	35 lbs.	1/4-20 x 1"
	HSSBSBT32-4	Stainless Steel	Carbon Steel	1"	75 lbs.	35 lbs.	1/4-20 x 1"
	HBSBT32-7	Carbon Steel	Carbon Steel	1"	75 lbs.	35 lbs.	5/16-18 x 1"
	HNBSBT32-7	Nylon	Carbon Steel	1"	75 lbs.	35 lbs.	5/16-18 x 1"
	HSSBSBT32-7	Stainless Steel	Carbon Steel	1"	75 lbs.	35 lbs.	5/16-18 x 1"
	HBSBT32-10	Carbon Steel	Carbon Steel	1"	75 lbs.	35 lbs.	3/8-16 x 1"
	HNBSBT32-10	Nylon	Carbon Steel	1"	75 lbs.	35 lbs.	3/8-16 x 1"
	HSSBSBT32-10	Stainless Steel	Carbon Steel	1"	75 lbs.	35 lbs.	3/8-16 x 1"
	B	HBSBT48-10	Carbon Steel	Carbon Steel	1-1/2"	250 lbs.	125 lbs.
HNBSBT48-10		Nylon	Carbon Steel	1-1/2"	250 lbs.	125 lbs.	3/8-16 x 1"
HSSBSBT48-10		Stainless Steel	Carbon Steel	1-1/2"	250 lbs.	125 lbs.	3/8-16 x 1"
C	HBSMBT20-4	Carbon Steel	Carbon Steel	5/8"	33 lbs.	16 lbs.	1/4-20 x 1"
	HNBSMBT20-4	Nylon	Carbon Steel	5/8"	33 lbs.	16 lbs.	1/4-20 x 1"
	HSSSMBT20-4	Stainless Steel	Carbon Steel	5/8"	33 lbs.	16 lbs.	1/4-20 x 1"
D	HBSMBT32-7	Carbon Steel	Carbon Steel	1"	200 lbs.	100 lbs.	5/16-18 x 1"
	HNBSMBT32-7	Nylon	Carbon Steel	1"	200 lbs.	100 lbs.	5/16-18 x 1"
	HSSSMBT32-7	Stainless Steel	Carbon Steel	1"	200 lbs.	100 lbs.	5/16-18 x 1"
E	HBSHDBT48-10	Carbon Steel	Carbon Steel	1-3/16"	750 lbs.	375 lbs.	3/8-16 x 1"
	HSSHDBT48-10	Stainless Steel	Carbon Steel	1-3/16"	750 lbs.	375 lbs.	3/8-16 x 1"

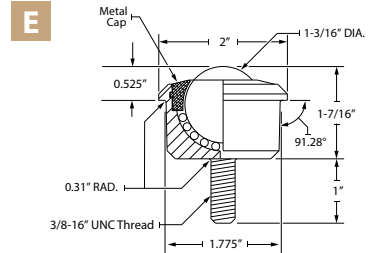

Heavy Duty

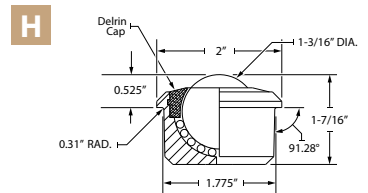
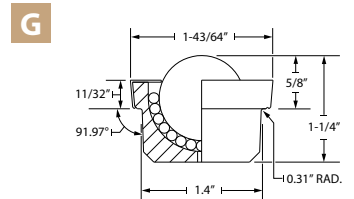
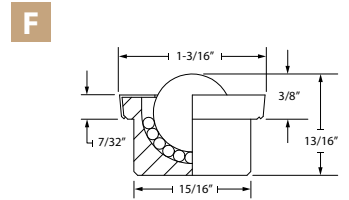

Heavy Duty

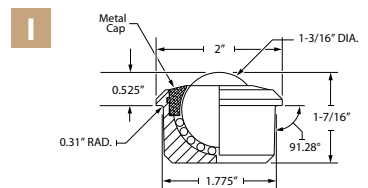

Heavy Duty

### Brake Option

Special order and available with the threaded stud mounted casters - please inquire



Shown: HBSMBT32-7-BRK



## Drop-In Caster/Transfers

	Part #	Ball Material	Housing Material	Ball Size	Load Rating	
					Ball Up	Ball Down
F	HBMBT-20	Carbon Steel	Carbon Steel	5/8"	33 lbs.	16 lbs.
	HBNMBT-20	Nylon	Carbon Steel	5/8"	33 lbs.	16 lbs.
	HSSMBT-20	Stainless Steel	Carbon Steel	5/8"	33 lbs.	16 lbs.
G	HBMBT-32	Carbon Steel	Carbon Steel	1"	200 lbs.	100 lbs.
	HBNMBT-32	Nylon	Carbon Steel	1"	200 lbs.	100 lbs.
H	HSSMBT-32	Stainless Steel	Carbon Steel	1"	200 lbs.	100 lbs.
	HBHDBT-56	Carbon Steel	Carbon Steel	1-3/16"	500 lbs.	250 lbs.
H	HSSHDBT-56	Stainless Steel	Carbon Steel	1-3/16"	500 lbs.	250 lbs.
	HBHDBTM-56	Carbon Steel	Carbon Steel	1-3/16"	750 lbs.	375 lbs.
I	HSSHDBTM-56	Stainless Steel	Carbon Steel	1-3/16"	750 lbs.	375 lbs.



## Polypropylene 2" Diameter Wheels



Single Ball Bearing Raceway • Nickel Finish  
Self Lubricating Bearings • Black Polypropylene

Lightweight, yet impact strength is far superior to hard rubber wheels. Offers superior resistance to most oils, chemicals, grease, solvents and acids. For light and medium duty applications.

Temperature Range: -5° F to 150° F

Hardness: 65(±5) Durometer Shore D Scale

### Without Brake

Part #	Top Portion	Wheel Material	Wheel Dia.	Wheel Width	Load Capacity Per Caster	Mounting Height	Swivel Radius	Pieces Per Carton
2IWP-A	A	Polypropylene	2"	13/16"	70 lbs.	2-5/8"	1-7/8"	100

### With Brake

Part #	Top Portion	Wheel Material	Wheel Dia.	Wheel Width	Load Capacity Per Caster	Mounting Height	Swivel Radius	Pieces Per Carton
2IWP-A-BR	A	Polypropylene	2"	13/16"	70 lbs.	2-5/8"	1-7/8"	100

### Top Portions Available:

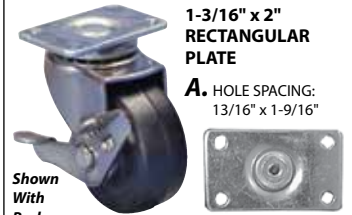

1-3/16" x 2" RECTANGULAR PLATE

A. HOLE SPACING: 13/16" x 1-9/16"

Shown With Brake



7/16" x 1-3/8" FRICTION RING STEM

B.

Shown Without Brake

## Thermoplastic Rubber (TPR) 1-1/2", 2" Diameter Wheels



Single Ball Bearing Raceway • Nickel Finish  
Self Lubricating Bearings • Gray Thermoplastic Rubber

High performance wheel offers the advantage of both hard and soft tread materials in a single wheel. Like a hard tread wheel, TPR rolls easily and is very durable. Like soft tread wheel, it rolls quietly, protects floors and resists impacts with a cushion ride. Non-marking wheel resists chemicals, water, steam, metal shavings and other floor debris. Features maximum weatherability.

Temperature Range: -5° F to 140° F

Hardness: 95(±5) Durometer Shore A Scale

### Without Brake

Part #	Top Portion	Wheel Material	Wheel Dia.	Wheel Width	Load Capacity Per Caster	Mounting Height	Swivel Radius	Pieces Per Carton
15IW-A-T	A	Thermoplastic Rubber	1-1/2"	11/16"	70 lbs.	2-5/16"	1-1/2"	100
15IW-B-T	B	Thermoplastic Rubber	1-1/2"	11/16"	70 lbs.	2-9/32"	1-1/2"	100
2IW-A-T	A	Thermoplastic Rubber	2"	3/4"	70 lbs.	2-9/16"	1-7/8"	100
2IW-B-T	B	Thermoplastic Rubber	2"	13/16"	70 lbs.	2-5/8"	1-7/8"	100

### With Brake

Part #	Top Portion	Wheel Material	Wheel Dia.	Wheel Width	Load Capacity Per Caster	Mounting Height	Swivel Radius	Pieces Per Carton
15IW-A-T-BR	A	Thermoplastic Rubber	1-1/2"	11/16"	70 lbs.	2-5/16"	1-13/16"	100
15IW-B-T-BR	B	Thermoplastic Rubber	1-1/2"	11/16"	70 lbs.	2-9/32"	1-13/16"	100
2IW-A-T-BR	A	Thermoplastic Rubber	2"	3/4"	70 lbs.	2-9/16"	1-7/8"	100
2IW-B-T-BR	B	Thermoplastic Rubber	2"	13/16"	70 lbs.	3-3/16"	2-3/16"	100

### Top Portions Available:

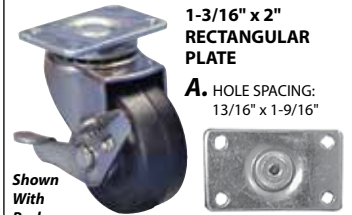

1-3/16" x 2" RECTANGULAR PLATE

A. HOLE SPACING: 13/16" x 1-9/16"

Shown With Brake

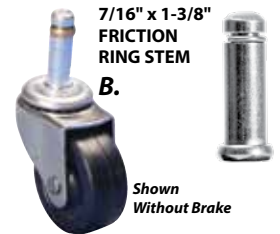

7/16" x 1-3/8" FRICTION RING STEM

B.

Shown Without Brake





## Soft Rubber 2", 2-1/2" & 3" Diameter Wheels

Single Ball Bearing Raceway • Nickel Finish  
Self Lubricating Bearings • Black Soft Rubber

Very attractive, all purpose wheel. Easy, quiet roll, resists impacts with a cushioned ride. Features maximum weatherability, resistance to chemicals, water and steam. Rejects floor debris.

**Temperature Range:** -30° F to 140° F

**Hardness:** 85(±5) Durometer Shore A Scale



### Without Brake

Part #	Top Portion	Wheel Material	Wheel Dia.	Wheel Width	Load Capacity Per Caster	Mounting Height	Swivel Radius	Pieces Per Carton
2IW-A	A							
2IW-B	B	Soft Rubber	2"	13/16"	70 lbs.	2-9/16"	1-7/8"	100
2IW-C	C							
2IW-D	D							
25IW-A	A					3-3/16"		
25IW-B	B	Soft Rubber	2-1/2"	13/16"	80 lbs.	3-1/16"	2-3/16"	100
25IW-C	C					3-1/16"		
25IW-D	D					3-1/16"		
3IW-A	A					3-5/8"		
3IW-B	B	Soft Rubber	3"	13/16"	90 lbs.	3-9/16"	2-1/2"	100
3IW-C	C					3-9/16"		
3IW-D	D					3-9/16"		

### With Brake

Part #	Top Portion	Wheel Material	Wheel Dia.	Wheel Width	Load Capacity Per Caster	Mounting Height	Swivel Radius	Pieces Per Carton
2IW-A-BR	A					2-9/16"	1-7/8"	
2IW-B-BR	B	Soft Rubber	2"	13/16"	70 lbs.	3-1/16"	2-3/16"	100
2IW-C-BR	C					2-9/16"	1-7/8"	
2IW-D-BR	D					2-9/16"	1-7/8"	
25IW-A-BR	A					3-3/16"		
25IW-B-BR	B	Soft Rubber	2-1/2"	13/16"	80 lbs.	3-1/16"	2-3/16"	100
25IW-C-BR	C					3-1/16"		
25IW-D-BR	D					3-1/16"		
3IW-A-BR	A					3-5/8"		
3IW-B-BR	B	Soft Rubber	3"	13/16"	90 lbs.	3-9/16"	2-1/2"	100
3IW-C-BR	C					3-9/16"		
3IW-D-BR	D					3-9/16"		

### Top Portions Available:



Shown With Brake

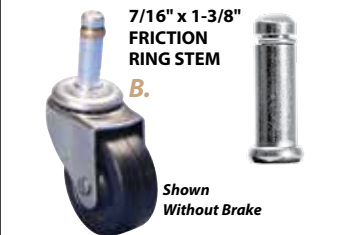

Shown Without Brake

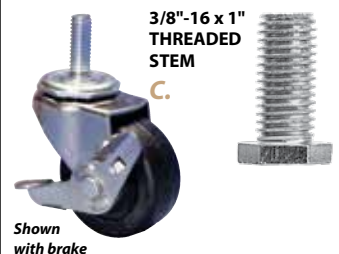

Shown with brake

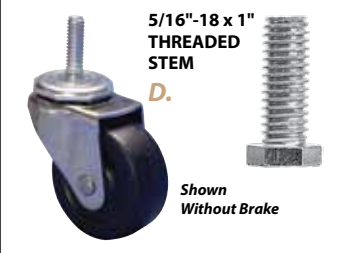

Shown Without Brake



## 2", 2-1/2", 3", 4" & 5" Diameter Wheels









SUMMIT Single Wheel Casters have been engineered and tested to exceed BIFMA, ANSI & GSA standards. APPLICATIONS: General usage, factories, warehouses, for display racks, dollies, boxes etc. A combination of STRENGTH and DURABILITY.

*A composition rubber wheel combining a soft rubber tread with a hard rubber core for quiet movement. A cushioned ride and maximum floor protection.*



- Double ball bearing raceway for long life and a smooth ride.
- Self lubricating bearings.
- Temperature operating range -40°F to 158°F.
- Brite Nickel or Zinc finish.

### Top Portions Available

<b>A.</b> 7/16" Dia. x 1" Long	
<b>B.</b> 7/16" Dia. x 1-3/8" Long	
<b>C.</b> 7/16" Dia. x 1-7/8" Long FRICTION RING STEM	
<b>D.</b> 5/16-18 x 1" Long	
<b>E.</b> 3/8-16 x 1/2" Long	
<b>F.</b> 3/8-16 x 1-1/2" Long THREADED STEM	
<b>G.</b> 1/2-13 x 1-1/2" Long THREADED STEM	
<b>H.</b> 1-3/16" x 2" TOP PLATE 13/16" x 1-9/16" Hole Spacing	

Top Portion	Part #	Wheel Dia.	Tread Width	Load Capacity Per Caster	Mounting Height	Swivel Radius	Pieces Per Carton
A	390-00-20DC-13-00	2"	1"	75 lbs.	2-9/16"	1-7/8"	80
	390-00-25DC-13-00	2-1/2"	1"	90 lbs.	3-1/16"	2-3/16"	80
	990-00-30DC-23-SD	3"	1"	100 lbs.	3-9/16"	2-1/2"	80
B	390-00-20DD-13-00	2"	1"	75 lbs.	2-9/16"	1-7/8"	80
	390-00-25DD-13-00	2-1/2"	1"	90 lbs.	3-1/16"	2-3/16"	80
	990-00-30DD-23-SD	3"	1"	100 lbs.	3-9/16"	2-1/2"	80
	990-01-31DD-23-SD	3"	1-1/4"	175 lbs.	3-9/16"	2-13/16"	32
	990-01-40DD-23-SD	4"	1"	125 lbs.	4-9/16"	3-3/8"	28
	990-01-41DD-23-SD	4"	1-1/4"	200 lbs.	4-15/16"	3-9/16"	28
C	990-01-50DD-23-SD	5"	1"	135 lbs.	5-9/16"	4-1/32"	20
	990-01-51DD-23-SD	5"	1-1/4"	210 lbs.	5-9/16"	4-5/32"	20
	990-00-30DF-23-SD	3"	1"	100 lbs.	3-9/16"	2-1/2"	80
D	990-01-50DF-23-SD	5"	1"	135 lbs.	5-9/16"	4-1/32"	20
	390-00-20BC-13-18	2"	1"	75 lbs.	2-9/16"	1-7/8"	80
E	390-00-25BC-13-18	2-1/2"	1"	90 lbs.	3-1/16"	2-3/16"	80
	990-00-30BC-23-18	3"	1"	100 lbs.	3-9/16"	2-1/2"	80
	390-00-20CA-13-16	2"	1"	75 lbs.	2-9/16"	1-7/8"	80
F	390-00-25CA-13-16	2-1/2"	1"	90 lbs.	3-1/16"	2-3/16"	80
	990-00-30CA-23-16	3"	1"	100 lbs.	3-9/16"	2-1/2"	80
	390-00-20CE-13-16	2"	1"	75 lbs.	2-9/16"	1-7/8"	80
G	990-00-25CE-13-16	2-1/2"	1"	90 lbs.	3-1/16"	2-3/16"	80
	990-00-30CE-23-16	3"	1"	100 lbs.	3-9/16"	2-1/2"	80
	990-01-31EE-23-13	3"	1-1/4"	175 lbs.	3-9/16"	2-13/16"	32
	990-01-40EE-23-13	4"	1"	125 lbs.	4-9/16"	3-3/8"	28
	990-01-41EE-23-13	4"	1-1/4"	200 lbs.	4-15/16"	3-9/16"	28
	990-01-50EE-23-13	5"	1"	135 lbs.	5-9/16"	4-1/32"	20
H	990-01-51EE-23-13	5"	1-1/4"	210 lbs.	5-15/16"	4-5/32"	20
	390-00-20TP-13-BO	2"	1"	75 lbs.	2-5/8"	1-7/8"	80
	390-00-25TP-13-BO	2-1/2"	1"	90 lbs.	3-3/16"	2-3/16"	80
	390-00-30TP-23-BO	3"	1"	100 lbs.	3-5/8"	2-1/2"	80

## Medium Duty

- Non-marring gray thermoplastic rubber (TPR) wheel
- Precision ball bearing supports heavier loads
- Full thread guard
- Tread lock brake
- Dual ball bearing raceway
- Zinc plated finish
- 3/8" diameter nut and bolt axle

*NSF Certificate Numbers And Manufacturer Name Available Upon Request.*

### Top Plate

**2-5/8" x 3-3/4" overall with 1-3/4" x 2-3/4" hole spacing for 5/16 bolts**

Swivel Part #	Swivel W/Side Brake Part #	Wheel Diameter	Tread Width	Load Capacity Per Caster	Mounting Height	Swivel Radius
<b>NF12-3TP</b>	<b>NF12-3TP-BRK</b>	3"		210 lbs.	4-1/4"	2-7/8"
<b>NF12-4TP</b>	<b>NF12-4TP-BRK</b>	4"	1-1/4"	260 lbs.	5-1/4"	3-3/8"
<b>NF12-5TP</b>	<b>NF12-5TP-BRK</b>	5"		280 lbs.	6-1/4"	3-7/8"



*Shown W/  
Side Brake*

### Threaded Stem

**1/2 - 13 x 1-1/2" Long**

Swivel Part #	Swivel W/Side Brake Part #	Wheel Diameter	Tread Width	Load Capacity Per Caster	Mounting Height	Swivel Radius
<b>NF12-3THR</b>	<b>NF12-3THR-BRK</b>	3"		210 lbs.	4-1/8"	2-7/8"
<b>NF12-4THR</b>	<b>NF12-4THR-BRK</b>	4"	1-1/4"	260 lbs.	5-1/8"	3-3/8"
<b>NF12-5THR</b>	<b>NF12-5THR-BRK</b>	5"		280 lbs.	6-1/8"	3-7/8"



*Shown W/  
Side Brake*

# Institutional Ergonomic Precision Raceway Casters

## 4" & 5" Diameter Wheels

Ideal for industrial, bakery, food service and medical equipment.

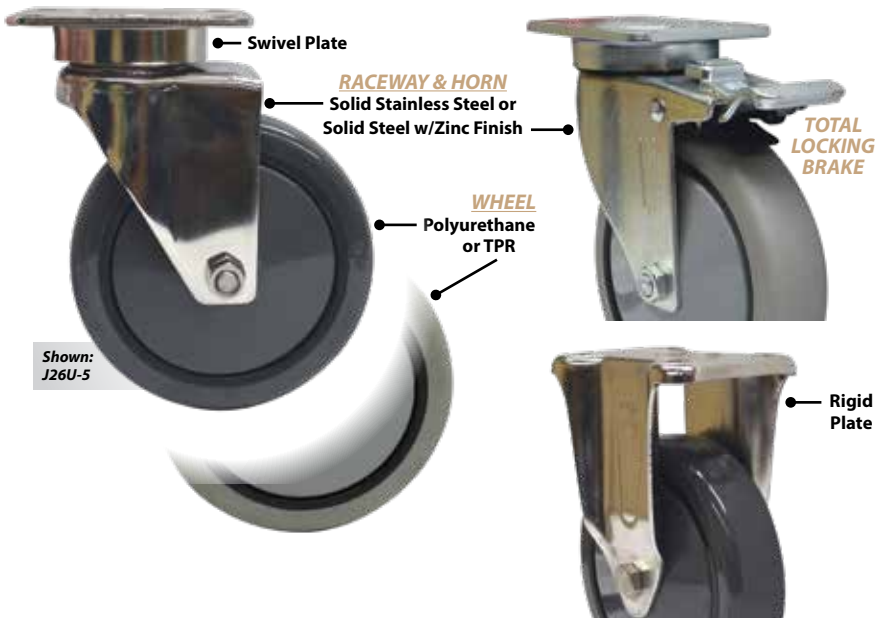

Shown: J26U-5

- Mounting hole diameter is 11/32" with plate
- Precision ball bearing raceway provides smooth mobility and quiet movement
- Sealed raceway
- Corrosion resistant Stainless Steel or Zinc Finish
- Durable high strength steel
- Tread guards on all precision bearing wheels
- **TPR:** Non-marring grey tread, rugged polypropylene core, Hardness is 70A, Temperature range (-40°F to +180°F)
- **Polyurethane:** PU Tread offers extended wear, Rugged polypropylene core, Hardness is 90A, Temperature range (-40°F to +180°F)
- **Both materials resist chemicals and oils**
- **Both treads are interlocked to avoid separation**

## Solid Stainless Steel Precision Raceway Casters

Part #	Wheel Material	Wheel Dia.	Wheel Color	Wheel Bearing	Tread Width	Mounting Height	Swivel Radius	Function	Plate Size	Load Capacity Per Caster	Carton Qty.
J26T-4	TPR	4"	Light Grey	Delrin	1-1/4"	5-7/16"	4-1/8"	Swivel	3-5/8" x 2-7/8"	250 lbs.	20
J26T-4BRK		4"	Tread and Hub	Delrin	1-1/4"	5-7/16"	4-1/8"	Total Locking Brake	3-5/8" x 2-7/8"	250 lbs.	20
J26T-4RG		4"		Delrin	1-1/4"	5-7/16"	4-1/8"	Rigid	4-1/8" x 2-15/16"	250 lbs.	20
J26U-4	Polyurethane	4"	Dark Grey	Delrin	1-1/4"	5-7/16"	4-1/8"	Swivel	3-5/8" x 2-7/8"	300 lbs.	20
J26U-4BRK		4"	Tread and Hub	Delrin	1-1/4"	5-7/16"	4-1/8"	Total Locking Brake	3-5/8" x 2-7/8"	300 lbs.	20
J26U-4RG		4"		Delrin	1-1/4"	5-7/16"	4-1/8"	Rigid	4-1/8" x 2-15/16"	300 lbs.	20
J26T-5	TPR	5"	Light Grey	Delrin	1-1/4"	6-1/2"	4-1/8"	Swivel	3-5/8" x 2-7/8"	300 lbs.	20
J26T-5BRK		5"	Tread and Hub	Delrin	1-1/4"	6-1/2"	4-1/8"	Total Locking Brake	3-5/8" x 2-7/8"	300 lbs.	20
J26T-5RG		5"		Delrin	1-1/4"	6-1/2"	4-1/8"	Rigid	4-1/8" x 2-15/16"	300 lbs.	20
J26U-5	Polyurethane	5"	Dark Grey	Delrin	1-1/4"	6-1/2"	4-1/8"	Swivel	3-5/8" x 2-7/8"	325 lbs.	20
J26U-5BRK		5"	Tread and Hub	Delrin	1-1/4"	6-1/2"	4-1/8"	Total Locking Brake	3-5/8" x 2-7/8"	325 lbs.	20
J26U-5RG		5"		Delrin	1-1/4"	6-1/2"	4-1/8"	Rigid	4-1/8" x 2-15/16"	325 lbs.	20

## Solid Steel w/Zinc Finish Precision Raceway Casters

Part #	Wheel Material	Wheel Dia.	Wheel Color	Wheel Bearing	Tread Width	Mounting Height	Swivel Radius	Function	Plate Size	Load Capacity Per Caster	Carton Qty.
A26T-4	TPR	4"	Light Grey	Precision	1-1/4"	5-7/16"	4-1/8"	Swivel	3-5/8" x 2-7/8"	250 lbs.	20
A26T-4BRK		4"	Tread and Hub	Precision	1-1/4"	5-7/16"	4-1/8"	Total Locking Brake	3-5/8" x 2-7/8"	250 lbs.	20
A26T-4RG		4"		Precision	1-1/4"	5-7/16"	4-1/8"	Rigid	4-1/8" x 2-15/16"	250 lbs.	20
A26U-4	Polyurethane	4"	Dark Grey	Precision	1-1/4"	5-7/16"	4-1/8"	Swivel	3-5/8" x 2-7/8"	300 lbs.	20
A26U-4BRK		4"	Tread and Hub	Precision	1-1/4"	5-7/16"	4-1/8"	Total Locking Brake	3-5/8" x 2-7/8"	300 lbs.	20
A26U-4RG		4"		Precision	1-1/4"	5-7/16"	4-1/8"	Rigid	4-1/8" x 2-15/16"	300 lbs.	20
A26T-5	TPR	5"	Light Grey	Precision	1-1/4"	6-1/2"	4-1/8"	Swivel	3-5/8" x 2-7/8"	300 lbs.	20
A26T-5BRK		5"	Tread and Hub	Precision	1-1/4"	6-1/2"	4-1/8"	Total Locking Brake	3-5/8" x 2-7/8"	300 lbs.	20
A26T-5RG		5"		Precision	1-1/4"	6-1/2"	4-1/8"	Rigid	4-1/8" x 2-15/16"	300 lbs.	20
A26U-5	Polyurethane	5"	Dark Grey	Precision	1-1/4"	6-1/2"	4-1/8"	Swivel	3-5/8" x 2-7/8"	325 lbs.	20
A26U-5BRK		5"	Tread and Hub	Precision	1-1/4"	6-1/2"	4-1/8"	Total Locking Brake	3-5/8" x 2-7/8"	325 lbs.	20
A26U-5RG		5"		Precision	1-1/4"	6-1/2"	4-1/8"	Rigid	4-1/8" x 2-15/16"	325 lbs.	20

# C100/C500 General Duty Plate Casters



## Soft Rubber • Hard Rubber • Polypropylene 2", 2-1/2", 3" & 4" Diameter Wheels

*Ideal for general use in factories, warehouses, stores, hotels, schools, offices, etc.  
Such applications may include furniture dollies, display racks, tool boxes, equipment carts, etc.*

### Available in 3 Wheel Styles:

**SOFT RUBBER** - This composition rubber wheel combines a soft rubber tread with a hard rubber core for quiet movement, a cushioned ride, and maximum floor protection. Temperature operating range is -40°F to +180°F. Hardness is 75A.

**HARD RUBBER** - A hard rubber molded composition throughout. It is impervious to oils, greases and gasoline. It offers many desirable characteristics; high load rating, good mobility, high impact resistance, and good floor protection. Temperature operating range is -40°F to +180°F. Hardness is 75A.

**POLYPROPYLENE** - This polypropylene wheel is light in weight, low in cost and high in impact strength. It resists water and chemical absorption and even stands up to repeated steam cleaning non-marking tread provides excellent floor protection. Temperature operating range is -20°F to +180°F. Hardness is 60D.

**TOP PLATE DIMENSIONS:**

**For Swivel & Swivel w/Brake Casters**

Wheel Dia.	Size of Top Plate D x E	Mounting Hole Spacing F x G	Mounting Hole Dia.
2"	1-7/8" x 2-9/16"	15/16" x 2-1/8"	1/4"
2-1/2"	2-3/4" x 3-13/16"	1-3/4" x 3"	5/16"
3"	3-1/8" x 4-1/8"	2-3/8" x 3-3/8" to 3-7/16"	5/16"
4"	4" x 5-1/8"	3" x 4"	3/8"

**TOP PLATE DIMENSIONS:**

**For Rigid Plate Casters**

Wheel Dia.	Size of Top Plate D x E	Mounting Hole Spacing F x G	Mounting Hole Dia.
2"	1-1/2" x 2-21/32"	15/16" x 2-1/8"	1/4"
2-1/2"	2-1/4" x 4-7/16"	1-1/16" x 3-1/2"	5/16"
3"	2-1/2" x 4-15/16"	1-3/16" x 4"	5/16"
4"	3-1/8" x 6-1/4"	1-3/4" x 5"	3/8"

### Swivel Plate Caster



Part #	Wheel Material	Wheel Dia.	Tread Width	Load Capacity Per Caster	Mounting Height	Swivel Radius	Pieces Per Carton
<b>C121-2</b>	Soft Rubber	2"	1"	90 lbs.	2-1/2"	1-11/16"	50
<b>C127-2</b>	Hard Rubber	2"	1"	150 lbs.	2-1/2"	1-11/16"	50
<b>C160-2</b>	Polypropylene	2"	15/16"	150 lbs.	2-1/2"	1-11/16"	50
<b>C127-25</b>	Hard Rubber	2-1/2"	1-1/8"	200 lbs.	3-3/16"	2-1/4"	50
<b>C121-3</b>	Soft Rubber	3"	1-1/4"	175 lbs.	3-13/16"	2-3/8"	24
<b>C127-3</b>	Hard Rubber	3"	1-1/4"	270 lbs.	3-13/16"	2-3/8"	24
<b>C160-3</b>	Polypropylene	3"	1-1/4"	270 lbs.	3-13/16"	2-3/8"	24
<b>C121-4</b>	Soft Rubber	4"	1-5/16"	225 lbs.	5"	3-3/16"	20
<b>C127-4</b>	Hard Rubber	4"	1-5/16"	350 lbs.	5"	3-3/16"	20

### Swivel Plate Caster w/Brake



Part #	Wheel Material	Wheel Dia.	Tread Width	Load Capacity Per Caster	Mounting Height	Swivel Radius	Pieces Per Carton
<b>C121-2SB</b>	Soft Rubber	2"	1"	90 lbs.	2-1/2"	1-15/16"	50
<b>C127-2SB</b>	Hard Rubber	2"	1"	150 lbs.	2-1/2"	1-15/16"	50
<b>C121-3SB</b>	Soft Rubber	3"	1-1/4"	175 lbs.	3-13/16"	2-1/2"	24
<b>C127-3SB</b>	Hard Rubber	3"	1-1/4"	270 lbs.	3-13/16"	2-1/2"	24
<b>C121-4SB</b>	Soft Rubber	4"	1-5/16"	225 lbs.	5"	3-5/16"	20
<b>C127-4SB</b>	Hard Rubber	4"	1-5/16"	350 lbs.	5"	3-5/16"	20

### Rigid Plate Caster



Part #	Wheel Material	Wheel Dia.	Tread Width	Load Capacity Per Caster	Mounting Height	Pieces Per Carton
<b>C521-2</b>	Soft Rubber	2"	1"	90 lbs.	2-1/2"	50
<b>C527-2</b>	Hard Rubber	2"	1"	150 lbs.	2-1/2"	50
<b>C560-2</b>	Polypropylene	2"	15/16"	150 lbs.	2-1/2"	50
<b>C521-25</b>	Soft Rubber	2-1/2"	1-1/8"	100 lbs.	3-3/16"	50
<b>C527-25</b>	Hard Rubber	2-1/2"	1-1/8"	200 lbs.	3-3/16"	50
<b>C521-3</b>	Soft Rubber	3"	1-1/4"	175 lbs.	3-13/16"	24
<b>C527-3</b>	Hard Rubber	3"	1-1/4"	270 lbs.	3-13/16"	24
<b>C560-3</b>	Polypropylene	3"	1-1/4"	270 lbs.	3-13/16"	24
<b>C521-4</b>	Soft Rubber	4"	1-5/16"	225 lbs.	5"	20
<b>C527-4</b>	Hard Rubber	4"	1-5/16"	350 lbs.	5"	20



## 2", 2-1/2" & 3" Diameter Wheels - SOFT WHEEL RUBBER

**APPLICATIONS:** General usage in factories, warehouses, display racks, trucks, tool boxes, etc.  
A combination of **STRENGTH, DURABILITY** and **ECONOMY.**

- Single Ball Bearing Raceway
- Zinc Finish
- Soft Rubber Wheel

### TOP PLATE DIMENSIONS:

FOR SWIVEL & SWIVEL W/BRAKE CASTERS

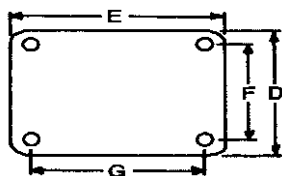

**821 PLATE**

FOR RIGID PLATE CASTERS

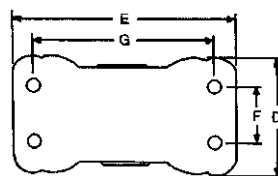

**921 PLATE**

Part #	Size Of Top Plate D x E	Mounting Hole Spacing F x G	Mounting Hole Dia.
<b>821-2</b>	1-7/8" x 2-5/8"	15/16" x 2-1/8"	1/4"
<b>821-25</b>	2-3/4" x 3-13/16"	1-3/4" x 3"	5/16"
<b>821-3</b>	3-1/8" x 4-1/8"	2-3/8" x 3-3/8"	5/16"

Part #	Size Of Top Plate D x E	Mounting Hole Spacing F x G	Mounting Hole Dia.
<b>921-2</b>	1-7/8" x 2-5/8"	15/16" x 2-1/8"	1/4"
<b>921-25</b>	2-3/8" x 4-3/8"	1" x 3-1/2"	5/16"
<b>921-3</b>	2-1/2" x 4-15/16"	1-3/16" x 4"	5/16"



### #821 Swivel Plate Caster

Part #	Wheel Dia.	Wheel Width	Load Capacity Per Caster	Overall Height	Swivel Radius
<b>821-2</b>	2"	1"	55 lbs.	2-5/8"	1-11/16"
<b>821-25</b>	2-1/2"	1-1/8"	66 lbs.	3-1/8"	2-3/16"
<b>821-3</b>	3"	1-1/4"	88 lbs.	3-13/16"	2-7/16"



### #821SB Swivel Plate Caster w/Brake

Part #	Wheel Dia.	Wheel Width	Load Capacity Per Caster	Overall Height	Swivel Radius
<b>821-2SB</b>	2"	1"	55 lbs.	2-5/8"	1-11/16"
<b>821-25SB</b>	2-1/2"	1-1/8"	66 lbs.	3-1/8"	2-3/16"
<b>821-3SB</b>	3"	1-1/4"	88 lbs.	3-13/16"	2-7/16"



### #921 Rigid Plate Caster

Part #	Wheel Dia.	Wheel Width	Load Capacity Per Caster	Overall Height
<b>921-2</b>	2"	1"	55 lbs.	2-5/8"
<b>921-25</b>	2-1/2"	1-1/8"	66 lbs.	3-1/8"
<b>921-3</b>	3"	1-1/4"	88 lbs.	3-13/16"



# DF Series - Dura Foam & TPR Wheels

## 3", 4" & 5" Diameter Wheels

- **1" Wide Tread:** 90-150 lbs. load capacity per caster
- **1-1/4" Wide Tread:** 270-350 lbs. load capacity per caster

**DURA FOAM** wheels are molded from a blended polyolefin thus producing a wheel for almost every application. This hard, non-marring, stain resistant compound is impervious to fat, acid & grease while providing a long lasting, maintenance-free wheel.

**APPLICATIONS:** Light-medium duty, usage in factories, warehouses, display racks, dollies, etc...



Shown: **DFS41**  
Swivel Plate Caster

### Polypropylene Wheel

- Hardness is 60D
- Temperature range (-20°F to +180°F)
- Low cost with high impact



Shown: **DFS42**  
Swivel Plate Caster  
w/Brake

### TPR Wheel

- Hardness is 70A
- Temperature range (-40°F to +180°F)
- Rugged polypropylene core with Soft Cushioned Tread

- Duo-level swivel construction
- Fully hardened raceways
- Factory lubricated with hi-temp grease
- Zinc plated with iridite dip for rust prevention and appearance
- Plain bearing
- 5/16" Hole diameter

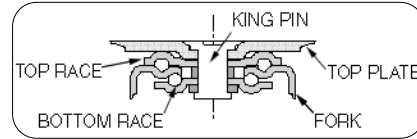

## Swivel Plate Caster

Part #	Wheel Material	Wheel Dia.	Tread Width	Plate Size	Plate Hole Spacing	Load Capacity Per Caster	Mounting Height	Swivel Radius	Carton Qty.
<b>DFS31-TPR</b>	TPR	3"	31/32"	3-5/8" x 2-9/16"	2-7/8" x 1-3/4"	90 lbs.	3-3/4"	2-3/4"	52
<b>DFS32</b>	Polypropylene	3"	1-1/4"	3-5/8" x 2-7/8"	2-15/16" x 1-3/4"	270 lbs.	3-13/16"	2-3/4"	40
<b>DFS41</b>	Polypropylene	4"	1"	3-5/8" x 2-9/16"	2-7/8" x 1-3/4"	140 lbs.	4-13/16"	3-5/16"	32
<b>DFS41-TPR</b>	TPR	4"	1"	3-5/8" x 2-9/16"	2-7/8" x 1-3/4"	115 lbs.	4-13/16"	3-5/16"	32
<b>DFS42</b>	Polypropylene	4"	1-1/4"	3-5/8" x 2-7/8"	2-15/16" x 1-3/4"	300 lbs.	5"	3-7/16"	30
<b>DFS51</b>	Polypropylene	5"	1"	3-5/8" x 2-9/16"	2-7/8" x 1-3/4"	150 lbs.	5-13/16"	3-15/16"	20
<b>DFS51-TPR</b>	TPR	5"	1"	3-5/8" x 2-9/16"	2-7/8" x 1-3/4"	125 lbs.	5-13/16"	3-15/16"	20
<b>DFS52</b>	Polypropylene	5"	1-1/4"	3-5/8" x 2-7/8"	2-15/16" x 1-3/4"	350 lbs.	6-1/8"	3-15/16"	20

## Swivel Plate Caster w/Brake

Part #	Wheel Material	Wheel Dia.	Tread Width	Plate Size	Plate Hole Spacing	Load Capacity Per Caster	Mounting Height	Swivel Radius	Carton Qty.
<b>DFS31-TPR</b>	TPR	3"	31/32"	3-5/8" x 2-9/16"	2-7/8" x 1-3/4"	90 lbs.	3-3/4"	2-3/4"	52
<b>DFS32</b>	Polypropylene	3"	1-1/4"	3-5/8" x 2-7/8"	2-15/16" x 1-3/4"	270 lbs.	3-13/16"	2-3/4"	40
<b>DFS41-TPR</b>	TPR	4"	1"	3-5/8" x 2-9/16"	2-7/8" x 1-3/4"	115 lbs.	4-13/16"	3-5/16"	32
<b>DFS42</b>	Polypropylene	4"	1-1/4"	3-5/8" x 2-7/8"	2-15/16" x 1-3/4"	300 lbs.	5"	3-7/16"	30
<b>DFS51</b>	Polypropylene	5"	1"	3-5/8" x 2-9/16"	2-7/8" x 1-3/4"	150 lbs.	5-13/16"	3-15/16"	20
<b>DFS51-TPR</b>	TPR	5"	1"	3-5/8" x 2-9/16"	2-7/8" x 1-3/4"	125 lbs.	5-13/16"	3-15/16"	20
<b>DFS52</b>	Polypropylene	5"	1-1/4"	3-5/8" x 2-7/8"	2-15/16" x 1-3/4"	350 lbs.	6-1/8"	3-15/16"	20

## Rigid Plate Caster



Shown: **DFR32**

Part #	Wheel Material	Wheel Dia.	Tread Width	Plate Size	Plate Hole Spacing	Load Capacity Per Caster	Mounting Height	Carton Qty.
<b>DFR31-TPR</b>	TPR	3"	31/32"	3-5/8" x 2-9/16"	2-7/8" x 1-3/4"	90 lbs.	3-3/4"	52
<b>DFR32</b>	Polypropylene	3"	1-1/4"	4-1/8" x 2-15/16"	2-15/16" x 1-3/4"	270 lbs.	3-13/16"	40
<b>DFR41-TPR</b>	TPR	4"	1"	3-5/8" x 2-9/16"	2-7/8" x 1-3/4"	115 lbs.	4-13/16"	32
<b>DFR42</b>	Polypropylene	4"	1-1/4"	4-1/8" x 2-15/16"	2-15/16" x 1-3/4"	300 lbs.	5"	30
<b>DFR51</b>	Polypropylene	5"	1"	3-5/8" x 2-9/16"	2-7/8" x 1-3/4"	150 lbs.	5-13/16"	20
<b>DFR51-TPR</b>	TPR	5"	1"	3-5/8" x 2-9/16"	2-7/8" x 1-3/4"	125 lbs.	5-13/16"	20
<b>DFR52</b>	Polypropylene	5"	1-1/4"	4-1/8" x 2-15/16"	2-15/16" x 1-3/4"	350 lbs.	6-1/8"	20

**110** **LOAD** **190**  
**lbs.** **TO** **lbs.**  
**CAPACITY**  
**PER CASTER**



**ADDS**  
**STRENGTH**  
**AND**  
**STYLE**

- Dust seal
- Thread guard
- Nut & bolt axle

## Super "G" Casters

- Gray, non-marring rubber wheel on polypropylene hub
- Economic Zinc finish
- Brake pedal material: Zinc plated steel
- Horn assembly: Pressed steel w/Zinc plating



Part #	Wheel Option	Wheel Diameter	Wheel Width	Mounting Height	Plate Size	Mounting Hole Spacing	Swivel Radius	Load Capacity Per Caster
<b>ISG100-1</b>	Swivel	4"	1-1/16"	5-1/4"	2-15/16" x 2-15/16"	1-29/32" x 1-29/32"	3-7/16"	160 lbs.

## Super "H" Casters

- Gray, non-marring TPR wheel on polypropylene hub
- Stylish nickel finish, (Polished mirror appearance)
- Horn assembly: Pressed steel w/Chrome plating



Part #	Wheel Option	Wheel Diameter	Wheel Width	Mounting Height	Plate Size	Mounting Hole Spacing	Swivel Radius	Load Capacity Per Caster
<b>7100-CHR</b>	Swivel	4"	15/16"	4-3/4"	2-3/8" x 2-3/8"	1-13/16" x 1-13/16"	3-5/32"	190 lbs.



## Gray Dyna - Tread TPR Casters

### 3", 4" & 5" Diameter Wheels



*Ideal For Tool Boxes, Bakery Racks, Dollies, Stock Trucks And Other Institutional Uses Requiring Good Mobility.*

- **Dyna-Tread TPR Wheels:** Gray thermoplastic rubber. Can resist most chemicals, caustics, oils & acids. Rugged polypropylene hub won't dent, mar, fade or stain. Tread and hub are double bonded and mechanically interlocked to eliminate thread separation. Give dollies, carts, and trucks a soft and cushioned non-marking ride. Temperature operating range in -40°F to +180°F.
- **Two independent rows** of hardened and polished ball bearings raceways.
- **Thread Guard Hub:** Thread guards can help protect wheel bearings from buildup of material such as threads that can cause binding. Thread guards promote longer life and lower maintenance of casters & wheels.
- **Self lubricated bearings**
- **Corrosion resistant zinc finish**
- **Nut & Bolt wheel attachment**

493-3TG  
(with Thread Guard)

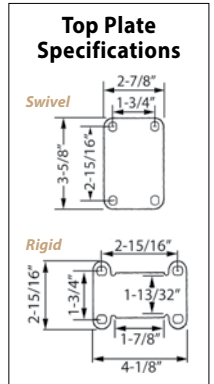

### Swivel Plate Caster



490-3

Part #	Wheel Dia.	Tread Width	Load Capacity Per Caster	Mounting Height	Swivel Radius	# Of Pieces Per Carton
<b>490-3</b>	3"	1-1/4"	180 lbs.	3-13/16"	2-3/4"	24
<b>493-3TG</b> (Thread Guard)	3"	1-1/4"	180 lbs.	3-13/16"	2-3/4"	24
<b>490-4</b>	4"	1-1/4"	250 lbs.	5"	3-7/16"	20
<b>493-4TG</b> (Thread Guard)	4"	1-1/4"	250 lbs.	5"	3-7/16"	20
<b>490-5</b>	5"	1-1/4"	300 lbs.	6-1/8"	3-15/16"	10
<b>493-5TG</b> (Thread Guard)	5"	1-1/4"	300 lbs.	6-1/8"	3-15/16"	10

### Swivel Plate Caster w/Brake



490-3SB

Part #	Wheel Dia.	Tread Width	Load Capacity Per Caster	Mounting Height	Swivel Radius	# Of Pieces Per Carton
<b>490-3SB</b>	3"	1-1/4"	180 lbs.	3-13/16"	2-3/4"	24
<b>493-3SB-TG</b> (Thread Guard)	3"	1-1/4"	180 lbs.	3-13/16"	2-3/4"	24
<b>490-4SB</b>	4"	1-1/4"	250 lbs.	5"	3-7/16"	20
<b>493-4SB-TG</b> (Thread Guard)	4"	1-1/4"	250 lbs.	5"	3-7/16"	20
<b>490-5SB</b>	5"	1-1/4"	250 lbs.	6-1/8"	3-15/16"	10
<b>493-5SB-TG</b> (Thread Guard)	5"	1-1/4"	250 lbs.	6-1/8"	3-15/16"	10

### Rigid Plate Caster



7790-3

Part #	Wheel Dia.	Tread Width	Load Capacity Per Caster	Mounting Height	# Of Pieces Per Carton
<b>7790-3</b>	3"	1-1/4"	180 lbs.	3-13/16"	24
<b>7793-3TG</b> (Thread Guard)	3"	1-1/4"	180 lbs.	3-13/16"	24
<b>7790-4</b>	4"	1-1/4"	250 lbs.	5"	20
<b>7793-4TG</b> (Thread Guard)	4"	1-1/4"	250 lbs.	5"	20
<b>7790-5</b>	5"	1-1/4"	300 lbs.	6-1/8"	10
<b>7793-5TG</b> (Thread Guard)	5"	1-1/4"	300 lbs.	6-1/8"	10

## Low Profile Medium/Heavy Duty

### 2" & 3" Diameter Wheels



*Made to support & move heavy office equipment where overall height is a limiting factor. Ideal for use on copiers, computers, large printers, & other heavy diagnostic equipment.*



HXEP629R

- Low profile, but does not compromise strength. Is produced in smaller diameters with high load rating capacities.
- Excellent floor protection; non marring.
- Will roll on carpeted floors.



HA435-3

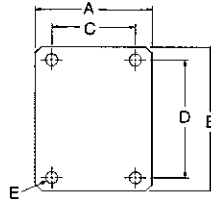

#### Wheel Material:

- **Polyflex (2" dia.):** This polypropylene wheel is light in weight, low in cost and high in impact strength. It resists water and chemical absorption and even stands up to repeated steam cleaning. Non-marking tread provides excellent floor protection.
- **Glass Filled Nylon (3" dia.):** This wheel offers high impact strength. It is produced with a roller bearing so that can withstand heavy loads. Non-marking tread provides excellent floor protection.
- **Finish:** Black oxide with corrosion resistant zinc top plate.
- **Stocked in swivel only.** Optional thumb screw brake may be available. Please inquire. Minimums apply.

#### TOP PLATE SPECIFICATIONS:

DIA.	A	B	C	D	E
2"	2-9/16"	3-5/8"	1-3/4"	2-7/8" to 3"	5/16"
3"	3-1/8"	4-1/8"	2-3/8"	3-13/32"	5/16"

Part #	Wheel Material	Wheel Dia.	Tread Width	Load Capacity Per Caster	Mounting Height	Swivel Radius	# Of Pieces Per Carton
HXEP629R	Polyflex	2"	1-11/16"	300 lbs.	2-27/32"	2-1/16"	40
HA435-3	Glass Filled Nylon	3"	1-13/16"	500 lbs.	3-31/32"	2-5/16"	25

## Low Profile Heavy Duty

### 3" Diameter Wheels



*Made to support HEAVY office equipment. Ideal for server cabinets, business machines, data storage racks, diagnostic equipment and mainframe enclosures.*

- Black Phenolic wheel
- Low profile single wheel
- Nut & Bolt wheel attachment



BMCH-3

Part #	Wheel Material	Wheel Dia.	Tread Width	Function	Plate Size	Load Capacity Per Caster	Mounting Height	Swivel Radius	# Of Pieces Per Carton
BMCH-3	Phenolic	3"	2"	Swivel w/Brake	3-1/8" x 4-1/4"	1200 lbs.	3-7/8"	2-1/8"	4

# Medium/Heavy Duty Industrial Casters

## 4", 5", 6" & 8" Diameter Wheels

Ideal for industrial, bakery, food service and medical equipment.



### Glass Filled Nylon Wheel

- High load capacity
- Water and chemical resistant
- Hardness is 65D
- Temperature range (-20°F to +250°F)



### TPR Wheel

- Non-marring grey tread
- Rugged polypropylene core
- Resists chemicals and oils
- Hardness is 70A
- Temperature range (-40°F to +180°F)



### Blue Poly Max Wheel

- High strength urethane tread
- Autoclave safe
- Resists chemical absorption
- Hardness is 90A
- Temperature range (-40°F to +180°F)

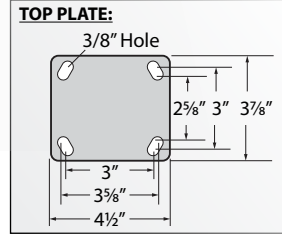

Part #	Wheel Material	Wheel Dia.	Wheel Color	Tread Width	Mounting Height	Swivel Radius	Function	Plate Size	Load Capacity Per Caster	# Of Pieces Per Carton
14GFN-4	Glass Filled	4"	Black	2"	5-5/8"	3-3/4"	Swivel	3-7/8" x 4-1/2"	400 lbs.	4
34GFN-4	Filled	4"	Black	2"	5-5/8"	3-3/4"	Rigid	3-7/8" x 4-1/2"	400 lbs.	4
14GFN-4BRK	Nylon	4"		2"	5-5/8"	3-3/4"	Swivel w/Brake	3-7/8" x 4-1/2"	400 lbs.	4
14TPR-4	TPR	4"	Grey Tread with	2"	5-5/8"	3-3/4"	Swivel	3-7/8" x 4-1/2"	350 lbs.	4
34TPR-4		4"	Black Hub	2"	5-5/8"	3-3/4"	Rigid	3-7/8" x 4-1/2"	350 lbs.	4
14TPR-4BRK		4"	Black Hub	2"	5-5/8"	3-3/4"	Swivel w/Brake	3-7/8" x 4-1/2"	350 lbs.	4
14PLY-4	Poly Max	4"	Blue Tread with	2"	5-5/8"	3-3/4"	Swivel	3-7/8" x 4-1/2"	600 lbs.	4
34PLY-4		4"	Black Hub	2"	5-5/8"	3-3/4"	Rigid	3-7/8" x 4-1/2"	600 lbs.	4
14PLY-4BRK		4"	Black Hub	2"	5-5/8"	3-3/4"	Swivel w/Brake	3-7/8" x 4-1/2"	600 lbs.	4
14GFN-5	Glass Filled	5"	Black	2"	6-1/2"	4-1/4"	Swivel	3-7/8" x 4-1/2"	650 lbs.	4
34GFN-5	Filled	5"	Black	2"	6-1/2"	4-1/4"	Rigid	3-7/8" x 4-1/2"	650 lbs.	4
14GFN-5BRK	Nylon	5"		2"	6-1/2"	4-1/4"	Swivel w/Brake	3-7/8" x 4-1/2"	650 lbs.	4
14TPR-5	TPR	5"	Grey Tread with	2"	6-1/2"	4-1/4"	Swivel	3-7/8" x 4-1/2"	450 lbs.	4
34TPR-5		5"	Black Hub	2"	6-1/2"	4-1/4"	Rigid	3-7/8" x 4-1/2"	450 lbs.	4
14TPR-5BRK		5"	Black Hub	2"	6-1/2"	4-1/4"	Swivel w/Brake	3-7/8" x 4-1/2"	450 lbs.	4
14PLY-5	Poly Max	5"	Blue Tread with	2"	6-1/2"	4-1/4"	Swivel	3-7/8" x 4-1/2"	900 lbs.	4
34PLY-5		5"	Black Hub	2"	6-1/2"	4-1/4"	Rigid	3-7/8" x 4-1/2"	900 lbs.	4
14PLY-5BRK		5"	Black Hub	2"	6-1/2"	4-1/4"	Swivel w/Brake	3-7/8" x 4-1/2"	900 lbs.	4
14GFN-6	Glass Filled	6"	Black	2"	7-1/2"	5"	Swivel	3-7/8" x 4-1/2"	650 lbs.	4
34GFN-6	Filled	6"	Black	2"	7-1/2"	5"	Rigid	3-7/8" x 4-1/2"	650 lbs.	4
14GFN-6BRK	Nylon	6"		2"	7-1/2"	5"	Swivel w/Brake	3-7/8" x 4-1/2"	650 lbs.	4
14TPR-6	TPR	6"	Grey Tread with	2"	7-1/2"	5"	Swivel	3-7/8" x 4-1/2"	550 lbs.	4
34TPR-6		6"	Black Hub	2"	7-1/2"	5"	Rigid	3-7/8" x 4-1/2"	550 lbs.	4
14TPR-6BRK		6"	Black Hub	2"	7-1/2"	5"	Swivel w/Brake	3-7/8" x 4-1/2"	550 lbs.	4
14PLY-6	Poly Max	6"	Blue Tread with	2"	7-1/2"	5"	Swivel	3-7/8" x 4-1/2"	1100 lbs.	4
34PLY-6		6"	Black Hub	2"	7-1/2"	5"	Rigid	3-7/8" x 4-1/2"	1100 lbs.	4
14PLY-6BRK		6"	Black Hub	2"	7-1/2"	5"	Swivel w/Brake	3-7/8" x 4-1/2"	1100 lbs.	4
14GFN-8	Glass Filled	8"	Black	2"	9-1/2"	6-1/8"	Swivel	3-7/8" x 4-1/2"	675 lbs.	4
34GFN-8	Filled	8"	Black	2"	9-1/2"	6-1/8"	Rigid	3-7/8" x 4-1/2"	675 lbs.	4
14GFN-8BRK	Nylon	8"		2"	9-1/2"	6-1/8"	Swivel w/Brake	3-7/8" x 4-1/2"	675 lbs.	4
14TPR-8	TPR	8"	Grey Tread with	2"	9-1/2"	6-1/8"	Swivel	3-7/8" x 4-1/2"	700 lbs.	4
34TPR-8		8"	Black Hub	2"	9-1/2"	6-1/8"	Rigid	3-7/8" x 4-1/2"	700 lbs.	4
14TPR-8BRK		8"	Black Hub	2"	9-1/2"	6-1/8"	Swivel w/Brake	3-7/8" x 4-1/2"	700 lbs.	4
14PLY-8	Poly Max	8"	Blue Tread with	2"	9-1/2"	6-1/8"	Swivel	3-7/8" x 4-1/2"	1200 lbs.	4
34PLY-8		8"	Black Hub	2"	9-1/2"	6-1/8"	Rigid	3-7/8" x 4-1/2"	1200 lbs.	4
14PLY-8BRK		8"	Black Hub	2"	9-1/2"	6-1/8"	Swivel w/Brake	3-7/8" x 4-1/2"	1200 lbs.	4

## Plastic Caster Inserts Material - Polyethylene

Tube Gauges vary - always test - free samples are available

### SQUARE

Square Insert



Stem Type 1

5/16" Gripneck Stem

Part #	Fits Tubing w/O.D. w/Dim.	Works w/Stem Type	Color
<b>1116-4</b>	1" x 16 GA.	2	Black
<b>1120-4</b>	1" x 18-20 GA.	2	Black
<b>975-1</b>	7/8" x 20 GA.	1	Black

### ROUND

Round Insert



Stem Type 2

7/16" Friction Ring Stem

Part #	Fits Tubing w/O.D. w/Dim.	Works w/Stem Type	Color
<b>1152-1</b>	5/8" x 20-22 GA.	1	Black
<b>1165-1</b>	3/4" x 20-22 GA.	1	Black
<b>205-PG-1318</b>	1" x 16 GA.	2	Black
<b>1158-4</b>	1" x 18 GA.	2	Black
<b>1157-1</b>	1" x 20-22 GA.	1	Black
<b>1190-4</b>	1-1/4" x 18 GA.	2	Black

▲ MAY BE USED FOR WOOD APPLICATIONS

## Medium Duty R.T. Caster Inserts

- An alternative to diecast metal inserts.
- The reinforced thermoplastic (R.T.) construction is virtually indestructible.
- Casters can be removed & replaced continuously.
- Will work with a 7/16" friction ring stem.

### SQUARE

Part #	Tube O.D.	GA.	Minimum Depth Required
<b>RT620SQ</b>	3/4"	16	2-1/4"
<b>RT650SQ</b>	3/4"	18	2-1/4"

### ROUND

Part #	Tube O.D.	GA.	Minimum Depth Required
<b>RT125RD</b>	1"	18	2-1/4"
<b>RT1370RD</b>	1-1/2"	16	2-1/4"

## Spring Steel Gripneck Sleeves



- Designed for wood applications.
- Hold 5/16" gripneck stem casters securely.

Socket Number	Description	Hole Diameter	Depth
<b>GN-505</b>	3/4" Toothed Trackplate	3/8"	1-5/8"

## Metal Caster Inserts



Part #	Fits	Works w/Stem Type
<b>A MS-40</b>	1/2" Hole	1
<b>B MS-716-ZP</b>	9/16" Hole	2

## Steel Brackets For Casters

- Brackets can be bolted on or welded to a variety of channel or angle iron legs.
- Fits a 7/16" dia. friction stem - maximum length of 1-3/8" long.

### Zinc Plated



**49**  
Inside Angle



**81-O**  
Flat Bracket

### Raw Steel



**81R**  
Flat Bracket

## Adaptors



Round or Square adaptor fits 16/18 Gauge tubing for 7/16" x 1-1/2" friction ring stem caster

Part #	Adaptor	Gauge Of Tube
<b>DSFRW-325</b>	1" Round	16/18
<b>DSFRW-485</b>	1-1/2" Round	16/18
<b>DSFRS-325</b>	1" Square	16/18
<b>DSFRS-485</b>	1-1/2" Square	16/18

## Self-Stick Casters & Feet

### Self-Stick Display Caster

- Set of 4 steel reinforced wheels hold up to 240 lbs.
- Stick surface measures 2" x 2".
- Wheels measure 1-1/4" diameter.
- Industrial grade adhesive bonds and holds permanently.
- Molded of Black HIPS.



**SA-C10**

### Self-Stick Display Foot

- Attaches to bottom of display with a permanent self adhesive.
- Holds approximately 400 lbs. per set of four.
- Lifts displays off of the floor by 3/4".
- Size is 2" x 2".
- Made of durable polyethylene.

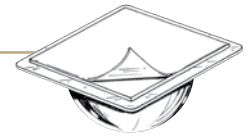

**SA-F10**



## TLR Series - Round and Square Adjustable Table Table Legs

**Material:** Steel (*Stainless Steel where noted*)

**Finishes:** Matte Black, Aluminum Silver, Brushed Steel, Chrome Plated, Stainless Steel

- Set of 4 Table Legs
- Steel Construction (*Stainless Steel where noted*)
- 28" Dining Height
- Load Rated at 220 lbs. per leg
- Optional stainless steel decorative set of feet, available for 60mm and 76mm round table legs.
- Includes mounting bracket and hardware



### ROUND TABLE LEG SETS

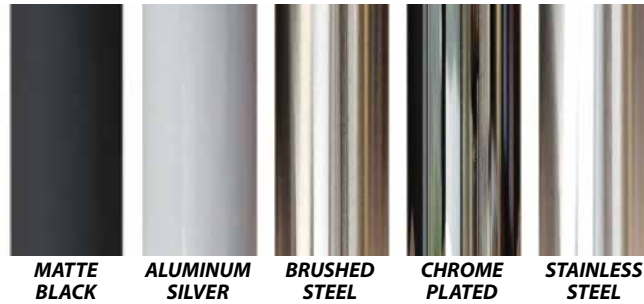
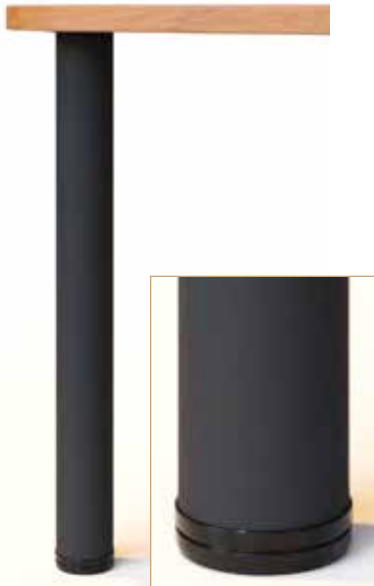

Part #	Size	Finish	Height
<b>TLR-50R-MB</b>		Matte Black	
<b>TLR-50R-AS</b>	50mm	Aluminum Silver	28"
<b>TLR-50R-BS</b>		Brushed Steel	
<b>TLR-60R-MB</b>		Matte Black	
<b>TLR-60R-AS</b>		Aluminum Silver	
<b>TLR-60R-BS</b>	60mm	Brushed Steel	28"
<b>TLR-60R-CHR</b>		Chrome Plated	
<b>TLR-60R-SS</b>		Stainless Steel	
<b>TLR-76R-MB</b>		Matte Black	
<b>TLR-76R-AS</b>		Aluminum Silver	
<b>TLR-76R-BS</b>	76mm	Brushed Steel	28"
<b>TLR-76R-CHR</b>		Chrome Plated	
<b>TLR-76R-SS</b>		Stainless Steel	

### OPTIONAL ACCESSORIES



**Brushed Stainless Steel decorative foot for 60mm & 76mm round legs, metal insert included**

Part #	Description
<b>TLR-60R-DECO-SS</b>	for 60mm round legs
<b>TLR-76R-DECO-SS</b>	for 76mm round legs

### SQUARE TABLE LEG SETS

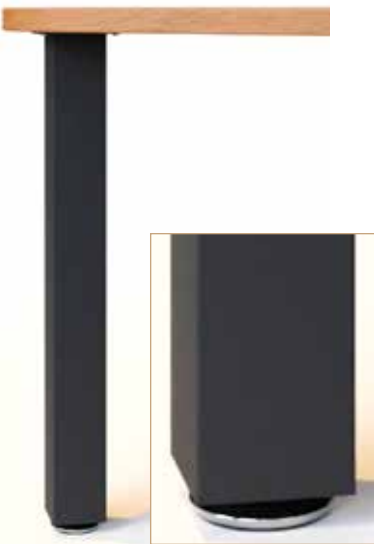

Part #	Size	Finish	Height
<b>TLR-50S-MB</b>		Matte Black	
<b>TLR-50S-BS</b>	50mm	Brushed Steel	28"
<b>TLR-50S-SS</b>		Stainless Steel	
<b>TLR-60S-MB</b>		Matte Black	
<b>TLR-60S-BS</b>	60mm	Brushed Steel	28"
<b>TLR-60S-SS</b>		Stainless Steel	
<b>TLR-76S-MB</b>		Matte Black	
<b>TLR-76S-BS</b>	76mm	Brushed Steel	28"
<b>TLR-76S-SS</b>		Stainless Steel	

