

Bring back that "Old World Appeal"



Closed on both ends

Shown: Hand Hewn, Walnut

- Realistic
- Lightweight and durable polyurethane
- 1" thickness
- Easy to install
- Will not warp, rot, decay or split

3 Sizes:

- 48"W x 6"H x 8"D
- 54"W x 6"H x 8"D
- 60"W x 6"H x 8"D

2 Finishes :

PECAN & WALNUT

2 Styles :

RIVERWOOD

texture resembling board lumber cut from an old sawmill.

HAND HEWN

with rugged texture and character.

Adding rustic flare, warmth, charm and architectural detail to any setting

HAND HEWN



Walnut

Pecan

RIVERWOOD



Walnut

Pecan

Part #	Finish	Style	Size
M4868-HH-WAL	Walnut	Hand Hewn	48"W x 6"H x 8"D
M4868-HH-PEC	Pecan	Hand Hewn	48"W x 6"H x 8"D
M4868-RW-WAL	Walnut	Riverwood	48"W x 6"H x 8"D
M4868-RW-PEC	Pecan	Riverwood	48"W x 6"H x 8"D
M5468-HH-WAL	Walnut	Hand Hewn	54"W x 6"H x 8"D
M5468-HH-PEC	Pecan	Hand Hewn	54"W x 6"H x 8"D
M5468-RW-WAL	Walnut	Riverwood	54"W x 6"H x 8"D
M5468-RW-PEC	Pecan	Riverwood	54"W x 6"H x 8"D
M6068-HH-WAL	Walnut	Hand Hewn	60"W x 6"H x 8"D
M6068-HH-PEC	Pecan	Hand Hewn	60"W x 6"H x 8"D
M6068-RW-WAL	Walnut	Riverwood	60"W x 6"H x 8"D
M6068-RW-PEC	Pecan	Riverwood	60"W x 6"H x 8"D

ARTISAN 16' BEAM KITS

New!

INSPIRED BY NATURE

Our Artisan Faux Wood Beams are molded from real wood. We only use high-end rigid polyurethane to achieve strength and stability, delivering a maintenance-free faux wood ceiling beam.

All of our Artisan Beams are hand-painted by our incredible team of craftsmen providing unique pieces just for your home.

- Material: Polyurethane
- For Interior Use
- Linear Coverage: 15'-8"
- Weight: 8 lbs. per beam
- 3-Sided "U" Beam measures:
6" W x 6" D x 94" L
with 1 open end & 1 closed end
- Made in North America



Each Kit Includes:
(2) 94" beams
(1) 20" x 1-5/8" beam strap

Additional straps, beam brackets and touch-up stain kits available.



FINISHES

WALNUT

GREY

UNFINISHED

UNFINISHED BEAMS HAVE A PRIMER COAT

TEXTURES

HAND HEWN

Distinguished by a hand-chopped texture with axe marks, this vintage look replicates reclaimed wood from the 1800's.

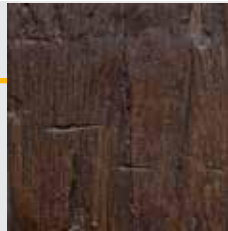

RIVER WOOD

Replicated from salvaged submerged wood in the Great Lakes, the quality of this water logged wood was enhanced during its long stay underwater. Exquisite and classic.

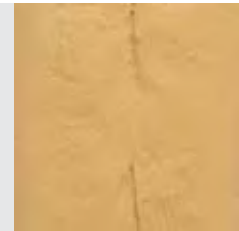
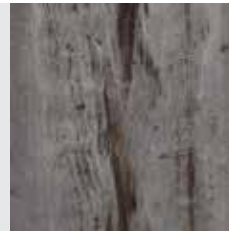
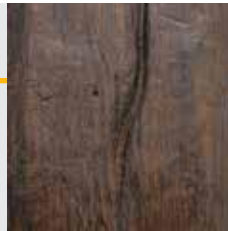

SAND BLASTED

Heavily sandblasted texture reveals swirling grain patterns that give a weathered, vintage look that dignifies any room.

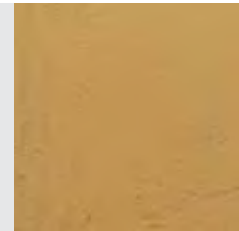

ARTISAN 16' BEAM KITS

INSPIRED BY NATURE

HAND HEWN



AB2-HH-*

**Available In Walnut (*W), Grey (*G) & Unfinished (*U)*



Shown in Walnut

RIVER WOOD



AB2-RW-*

**Available In Walnut (*W), Grey (*G) & Unfinished (*U)*



Shown in Walnut



ARTISAN 16' BEAM KITS

INSPIRED BY NATURE

SAND BLASTED



Shown in Walnut

AB2-SB-*

**Available In Walnut (*W), Grey (*G) & Unfinished (*U)*

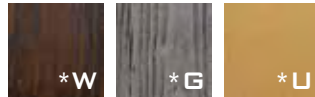

ACCESSORIES



Unfinished beams shown with custom stain on site.

BRACKETS

AB-BRKT-*

**Available In :
Industrial Bolt Head (*ID)
Round Nail Head (*RD)
Square Nail Head (*SQ)*



Shown in Industrial Bolt Head



Additional straps and brackets available, visit www.outwater.com for more details.

STRAPS

VINSTRAP

Single Strap
42" L x 1-5/8" W
Bolt Spacing: 1-3/8" (2-1/4" C-C)

TOUGH UP KITS

AB-*/TUK

**Available In Walnut (*W) & Grey (*G)*





Walnut

Hand Hewn Beam Series

12'-9" Lengths * Closed on one end*

3 Finishes Available

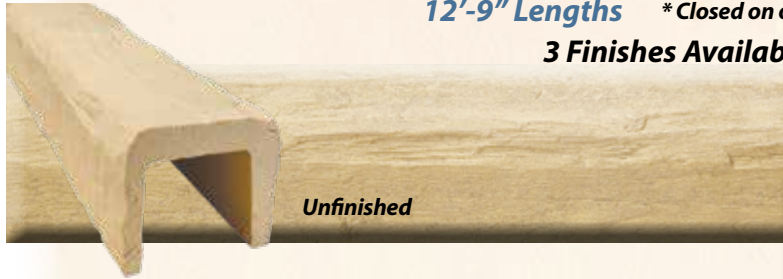

Unfinished

Our **Rustic Beams** allow you to bring back that "Old World Style" and to any room with their rustic warmth and charm. These beams are lightweight and easy to install.

Rustic Beams were fallen logs, hewn into shape using a broad axe. Forging ahead and settling the new frontier, early settlers did not have access to mills and machinery. They shaped the beams used in their homes and business by hand, using their axes and small tools. This resulted in a beam with rugged texture and character.



New
Medium Oak

Part #	Width A	Height B	Top Inside Width C	Bottom Inside Width D
HH20-55*	5"	5"	2-3/4"	2-1/4"
HH30-85*	8"	5-1/8"	6-1/4"	6"
HH40-87*	7-1/2"	6-5/8"	5"	4-7/8"

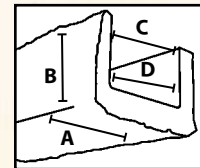

* For unfinished add -UNF to the part number

* For medium oak add -MEDOAK to the part number

ACCESSORIES



RUBBER BEAM STRAPPING



**Single Strap
VINSTRAP**
(Black/Silver)
42" L x 1-5/8" W
Bolt Spacing: 1-3/8" (2-1/4" C-C)



**Double Strap
DB-STRAP**
(Black/Silver)
41" L x 2-3/4" W
Bolt Spacing: 4" (4-3/4" C-C)

Due to photographic imaging, products may vary slightly in color. All sizes listed are approximate. Samples are available, please inquire.



* Open on both ends*

Vintage Beam Series

15'-6" Lengths

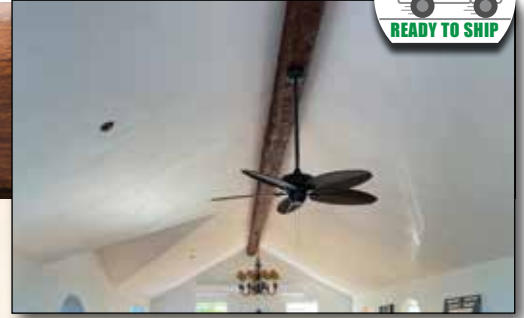

Part #	Width A	Height B	Top Inside Width C	Bottom Inside Width D
New VINBEAM-10*	5-7/8"	3-15/16"	4-1/2"	4-1/4"
New VINBEAM-20*	4-3/4"	4-3/4"	3-3/8"	3-1/8"
New VINBEAM-30*	7-1/2"	5-7/8"	6"	5-3/4"
New VINBEAM-40*	10-5/8"	4-15/16"	5-7/8"	5-5/8"
VINBEAM-50*	9"	9"	6"	5-1/2"
VINBEAM-60*	10"	12"	8"	7"

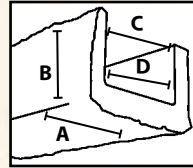

2 Finishes Available



Unfinished



Finished

* For unfinished add -UNF to the part number

For Custom Sizes See page S-12

ACCESSORIES

RUBBER BEAM STRAPPING



Single Strap
VINSTRAP
(Black/Silver)
42" L x 1-5/8" W
Bolt Spacing: 1-3/8" (2-1/4" C-C)



Double Strap
DB-STRAP
(Black/Silver)
41" L x 2-3/4" W
Bolt Spacing: 4" (4-3/4" C-C)



3-1/2 oz.
Touch-up Stain for
Vintage Beams
VINSTAIN



* Open on both ends*

Old World Beam Series

16' & 20' Lengths



Part #	Width A	Height B	Top Inside Width C	Bottom Inside Width D	Length
OWB-44*	4-1/2"	4-1/2"	2"	2"	16'
OWB-57*	5-1/4"	7-1/4"	3-3/8"	3-3/8"	20'
OWB-76*	7"	6-1/4"	5"	4-3/4"	16'
OWB-79*	7-1/4"	8-1/2"	4-3/4"	4-1/2"	20'
OWB-1513*	15-1/4"	12-7/8"	13"	12-1/4"	16'

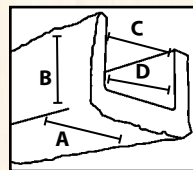

2 Finishes Available



Unfinished



Finished

* For unfinished add -UNF to the part number

Product thickness will vary but is an average of 1" thick.



WB-STAIN

Includes: (1) 16 oz. can of Brown and (1) 8 oz. can of Dark Brown.
Use Dark Brown stain to highlight cracks, splits and knots.

Due to photographic imaging, products may vary slightly in color.
All sizes listed are approximate. Samples are available, please inquire.

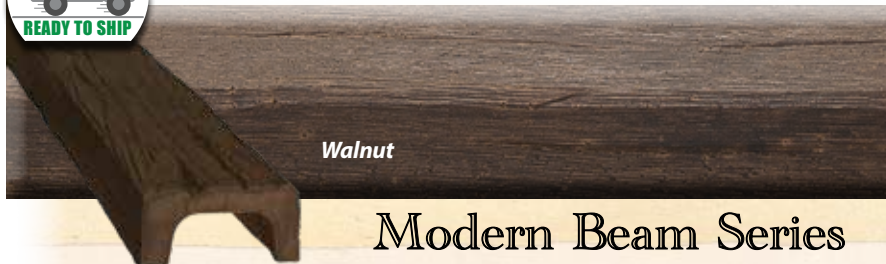

Modern Beam Series

12'-9" Lengths * Closed on one end*

3 Finishes Available



Our **Contemporary** offers a smooth milled appearance. Creating a sense of casual elegance adding visual interest with their clean lines.



Part #	Width A	Height B	Top Inside Width C	Bottom Inside Width D
MOD-BEAM10*	4-3/8"	2-1/4"	3"	2-3/4"
MOD-BEAM20*	5-7/8"	3-7/8"	4-3/4"	3-1/2"
MOD-BEAM30*	7-7/8"	5-7/8"	6-5/8"	4"

* For unfinished add -UNF to the part number

* For medium oak add -MEDOAK to the part number

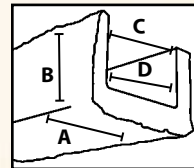

ACCESSORIES

RUBBER BEAM STRAPPING



Due to photographic imaging, products may vary slightly in color. All sizes listed are approximate. Samples are available, please inquire.





* Open on both ends*

Classic Raised Grain Beam Series

15'-6" Lengths



2 Finishes Available

Part #	Width A	Height B	Top Inside Width C	Bottom Inside Width D
CRB-66*	6"	6"	4-3/8"	4"
CRB-86*	8-1/8"	6"	6-1/4"	6-1/8"

* For unfinished add -UNF to the part number

For Custom Sizes See page S-12

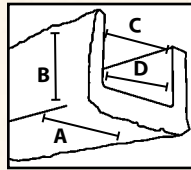

Unfinished



Finished

ACCESSORIES



RUBBER BEAM STRAPPING



Single Strap
VINSTRAP
(Black/Silver)
42" L x 1-5/8" W
Bolt Spacing: 1-3/8" (2-1/4" C-C)

Double Strap
DB-STRAP
(Black/Silver)
41" L x 2-3/4" W
Bolt Spacing: 4" (4-3/4" C-C)



3-1/2 oz.
Touch-up Stain for
Vintage Beams
VINSTAIN



* Open on both ends*

Milled Style Beam Series

14' Lengths



Finishes Available

PART #	Width A	Height B	Top Inside Width C	Bottom Inside Width D
BMCDR8X6X168S	5-3/4"	7-1/4"	5-3/4"	5-3/4"

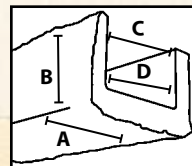

Unfinished

Due to photographic imaging, products may vary slightly in color.
All sizes listed are approximate. Samples are available, please inquire.



New World Beam Series

56", 12', 14', 16', 20' & 22' Lengths

Part #	Width A	Height B	Top Inside Width C	Bottom Inside Width D	Length
NWB-35*	3-1/2"	5-1/4"	1-3/4"	1-1/4"	22'
NWB-45*	4"	5-1/2"	2-1/4"	2-1/8"	16'
NWB-55*	5-3/8"	5-1/4"	3-3/8"	3-1/8"	20'
NWB-57*	5-1/2"	7-1/8"	4"	3-1/2"	20'
NWB-65*	6"	4-7/8"	4"	3-3/4"	20'
NWB-67*	6"	7"	4-3/8"	4"	12'
NWB-69*	6"	8-3/4"	4"	3-1/2"	56"
NWB-75*	8"	5-1/2"	6"	6"	14'
NWB-76*	7-1/2"	6-1/4"	5"	5"	20'
NWB-78*	6-3/8"	7-3/8"	4-3/8"	3-7/8"	20'
NWB-79*	7"	8-3/4"	5"	4-1/4"	20'
NWB-711*	7-1/4"	10-3/4"	5-1/4"	4-1/4"	20'
NWB-811*	8"	11-1/4"	6-1/4"	5-1/4"	14'
NWB-911*	9"	11"	6-3/4"	6-1/4"	20'
NWB-914*	8-5/8"	14-1/4"	6-1/2"	6"	20'
NWB-915*	9-1/2"	14-3/4"	6-3/4"	6-3/4"	14'
NWB-1114*	12"	14-1/4"	9-5/8"	9"	14'
NWB-1118*	11-1/2"	18-3/4"	8-1/4"	8-1/4"	16'
NWB-1515*	14-1/2"	14-3/4"	12-1/4"	11-3/4"	16'

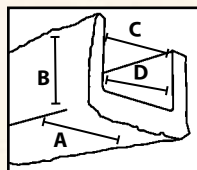

2 Finishes Available



Unfinished



Finished

* For unfinished add -UNF to the part number

Product thickness will vary but is an average of 1" thick.

ACCESSORIES

RUBBER BEAM STRAPPING



Single Strap
VINSTRAP
(Black/Silver)
42" L x 1-5/8" W
Bolt Spacing: 1-3/8" (2-1/4" C-C)



Double Strap
DB-STRAP
(Black/Silver)
41" L x 2-3/4" W
Bolt Spacing: 4" (4-3/4" C-C)

Due to photographic imaging, products may vary slightly in color. All sizes listed are approximate. Samples are available, please inquire.



WB-STAIN

Includes: (1) 16 oz. can of Brown and (1) 8 oz. can of Dark Brown. Use Dark Brown stain to highlight cracks, splits and knots.



* Open on both ends*

Rough Sawn Beam Series

10', 16', 8' 6" & 20' Lengths



Part #	Width A	Height B	Top Inside Width C	Bottom Inside Width D	Lengths
RSB-33*	4"	2-7/8"	2-3/8"	1-7/8"	20'
RSB-34*	3-1/2"	4-1/2"	1-3/4"	1-3/4"	20'
RSB-57*	5-1/8"	7"	3-7/8"	3-1/4"	16'
RSB-511*	5-3/8"	11-1/8"	3-1/8"	2-3/4"	8'6"
RSB-77*	7-1/4"	7-1/4"	5-3/8"	4-1/2"	20'
RSB-88*	8-1/2"	8-1/2"	6-1/2"	6-1/2"	10'
RSB-815*	8-3/4"	15-1/4"	6"	5"	10'

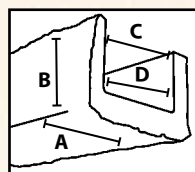

2 Finishes Available



Unfinished



Finished

* For unfinished add -UNF to the part number

Product thickness will vary but is an average of 1" thick.



ACCESSORIES

RUBBER BEAM STRAPPING



Single Strap
VINSTRAP
 (Black/Silver)
 42" L x 1-5/8" W
 Bolt Spacing: 1-3/8" (2-1/4" C-C)



Double Strap
DB-STRAP
 (Black/Silver)
 41" L x 2-3/4" W
 Bolt Spacing: 4" (4-3/4" C-C)

New

WB-STAIN

Includes: (1) 16 oz. can of Brown and (1) 8 oz. can of Dark Brown.
 Use Dark Brown stain to highlight cracks, splits and knots.

Due to photographic imaging, products may vary slightly in color.
 All sizes listed are approximate. Samples are available, please inquire.



**CUSTOM POLYURETHANE
FAUX BEAMS
PATTERNS & FINISHES**

COMING SOON

PLEASE INQUIRE



**CUSTOM POLYURETHANE
FAUX BEAMS
PATTERNS & FINISHES**

COMING SOON

PLEASE INQUIRE

Unfinished Beam Program

Create your own color

Simply make your selection from the many gel stain finishes that best suits your room.



Brush on your stain and enjoy the Beauty

Why limit your choices of color?

FREE
Unfinished Beam
Sample Available.

Please call our Sales Dept.
to request sample.

Sample piece
Approx. 6"-8"



MINWAX GEL STAIN

One can of MINWAX Gel Stain will stain approximately 5 to 8 Beams (13 ft. beams).



Visit your Home Centers for endless color selections

Hint:
Water Base
Gel Stains have
a low gloss (flat)
appearance.

Exterior Use:

It is Recommended when BEAMS are used for Entrance Ways or Over Terraces that an outdoor deck stain is applied.

- High Density Polyurethane.
- Light weight & Easy to install.
- Coordinating corbels and accessories available.
- Virtually impossible to distinguish from real wood.
- Will not rot, warp, decay or split.
- Our beams can be used indoors and outdoors. When using outdoors, a UV coating must be applied to prevent the pre-finished product from fading over time.

EASY INSTALLATION

Instructions:

1. Secure a wood block to the ceiling every 4-5 ft.
2. Slide the opening of the beam over the wooden blocks.
3. Place a line of silicone caulk on the beam.
4. Attach two screws/nails into the side of the beam. This will secure the beam to the ceiling.



TIN PLATED STAMPED CEILING TILES & CORNICES

LIGHTWEIGHT • TIN FREE STEEL • 30 GAUGE • .010 THICK

Our Stamped Ceiling Panels feature an impressive mix of texture and nostalgia, with contemporary and traditional styling and finely crafted details.

- **Steel** Ceiling tiles and cornices are shipped uncoated or choose from one of our pre-finished options below. Powder Coated, Lacquered, Brass, Copper, Chrome or Hand Painted Vintage.
- **Powder Coated:** Powder coating is a process of applying dry paint through an electrostatic process, then cured with heat.
- **Lacquer:** The Lacquer finish is also a powder coated process proprietary to us that allows for a baked on consistent clear finish.
- **Brass, Copper and Chrome:** Anodized finish over aluminum base metal. Tiles come with a protective peel off PVC sheet.
- **Hand Painted:** Hand painted vintage finishing process is where the base color is applied and then a formula is manipulated to create unique antique faux finishes.



FINISHES AVAILABLE

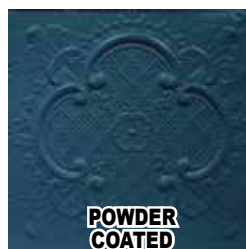
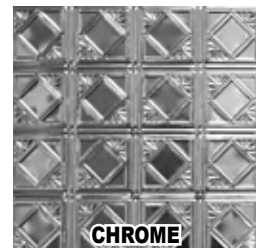
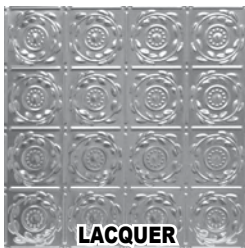

For all Powder Coated and Hand Painted Vintage finishes, please visit our website.

Decorative Stamped Steel Ceiling Panels

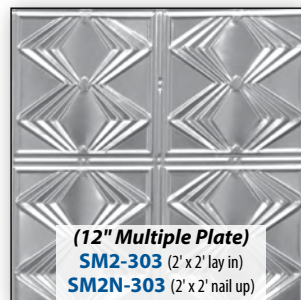
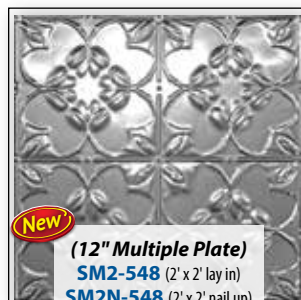
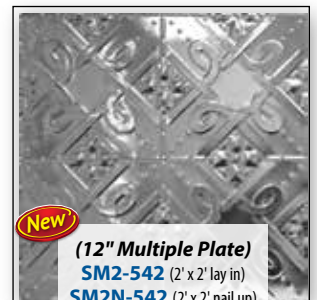
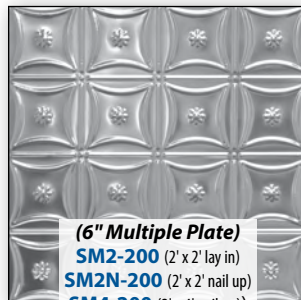
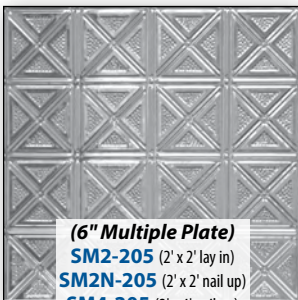
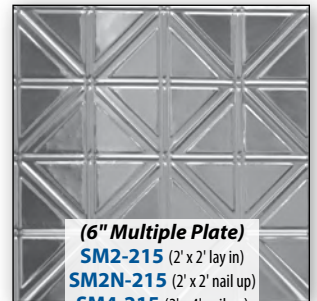
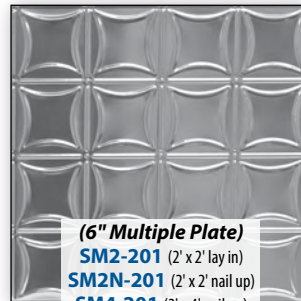
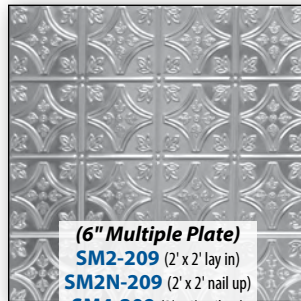
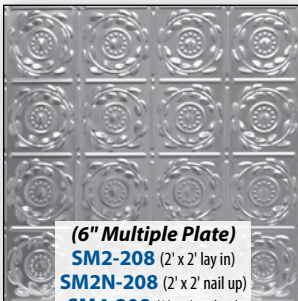
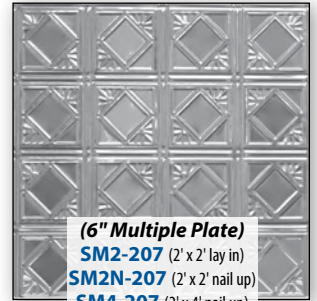
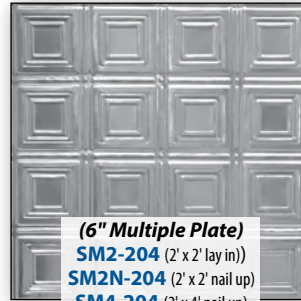
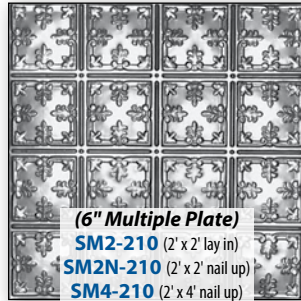
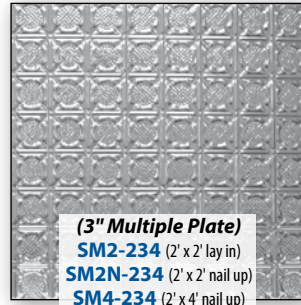
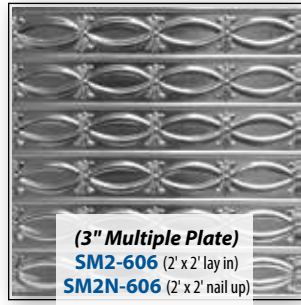

CUSTOM ORDERS
 If acoustics are a concern, all 2' x 2' tiles are available perforated. Please inquire for pricing and production time.
 For all Powder Coated and Hand Painted Vintage finishes, please visit our website.

Decorative Stamped Steel Ceiling Panels

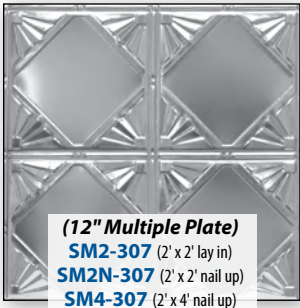

(12" Multiple Plate)
SM2-307 (2' x 2' lay in)
SM2N-307 (2' x 2' nail up)
SM4-307 (2' x 4' nail up)

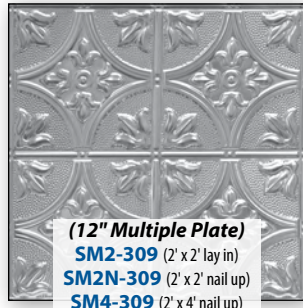

(12" Multiple Plate)
SM2-309 (2' x 2' lay in)
SM2N-309 (2' x 2' nail up)
SM4-309 (2' x 4' nail up)

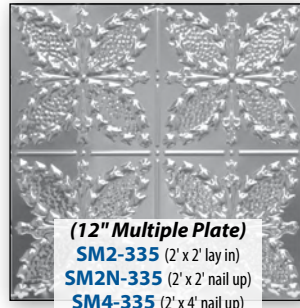

(12" Multiple Plate)
SM2-335 (2' x 2' lay in)
SM2N-335 (2' x 2' nail up)
SM4-335 (2' x 4' nail up)

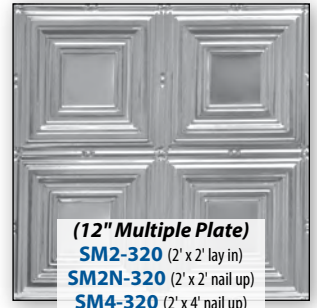

(12" Multiple Plate)
SM2-320 (2' x 2' lay in)
SM2N-320 (2' x 2' nail up)
SM4-320 (2' x 4' nail up)

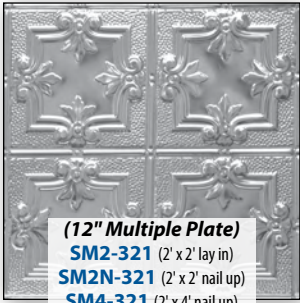

(12" Multiple Plate)
SM2-321 (2' x 2' lay in)
SM2N-321 (2' x 2' nail up)
SM4-321 (2' x 4' nail up)

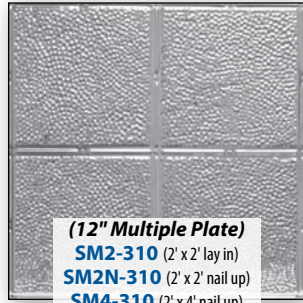

(12" Multiple Plate)
SM2-310 (2' x 2' lay in)
SM2N-310 (2' x 2' nail up)
SM4-310 (2' x 4' nail up)

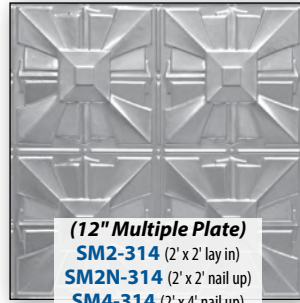

(12" Multiple Plate)
SM2-314 (2' x 2' lay in)
SM2N-314 (2' x 2' nail up)
SM4-314 (2' x 4' nail up)



New
(24" Multiple Plate)
SM2-536 (2' x 2' lay in)
SM2N-536 (2' x 2' nail up)



New
(24" Multiple Plate)
SM2-537 (2' x 2' lay in)
SM2N-537 (2' x 2' nail up)



New
(24" Multiple Plate)
SM2-538 (2' x 2' lay in)
SM2N-538 (2' x 2' nail up)



New
(24" Multiple Plate)
SM2-539 (2' x 2' lay in)
SM2N-539 (2' x 2' nail up)



New
(24" Multiple Plate)
SM2-541 (2' x 2' lay in)
SM2N-541 (2' x 2' nail up)

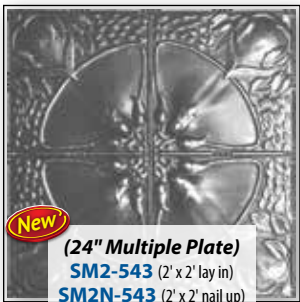

New
(24" Multiple Plate)
SM2-543 (2' x 2' lay in)
SM2N-543 (2' x 2' nail up)

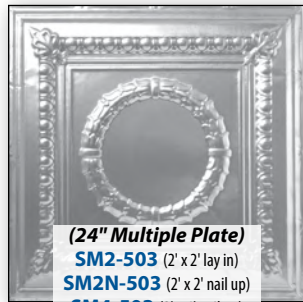

(24" Multiple Plate)
SM2-503 (2' x 2' lay in)
SM2N-503 (2' x 2' nail up)
SM4-503 (2' x 4' nail up)

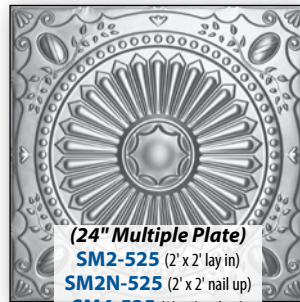

(24" Multiple Plate)
SM2-525 (2' x 2' lay in)
SM2N-525 (2' x 2' nail up)
SM4-525 (2' x 4' nail up)



(24" Multiple Plate)
SM4-510 (2' x 4' nail up)

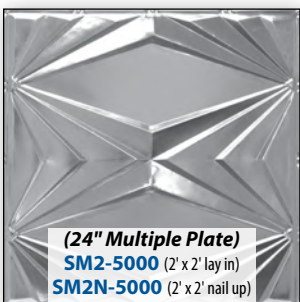

(24" Multiple Plate)
SM2-500 (2' x 2' lay in)
SM2N-500 (2' x 2' nail up)
SM4-500 (2' x 4' nail up)



(24" Multiple Plate)
SM2-504 (2' x 2' lay in)
SM2N-504 (2' x 2' nail up)
SM4-504 (2' x 4' nail up)

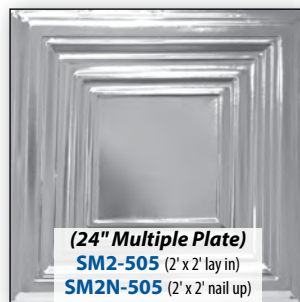

(24" Multiple Plate)
SM2-505 (2' x 2' lay in)
SM2N-505 (2' x 2' nail up)
SM4-505 (2' x 4' nail up)

CUSTOM ORDERS

If acoustics are a concern, all 2' x 2' tiles are available perforated. Please inquire for pricing and production time.

For all Powder Coated and Hand Painted Vintage finishes, please visit our website.

Decorative Stamped Steel Ceiling Panels

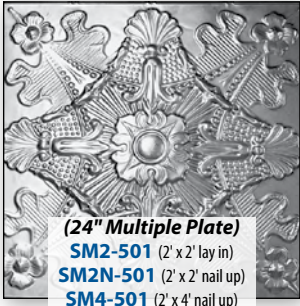

(24" Multiple Plate)
SM2-501 (2' x 2' lay in)
SM2N-501 (2' x 2' nail up)
SM4-501 (2' x 4' nail up)

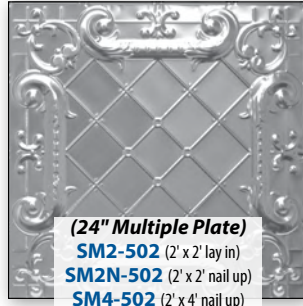

(24" Multiple Plate)
SM2-502 (2' x 2' lay in)
SM2N-502 (2' x 2' nail up)
SM4-502 (2' x 4' nail up)

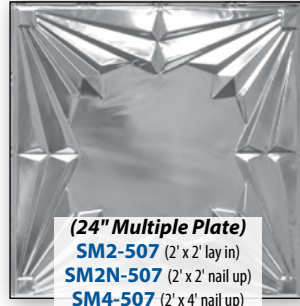

(24" Multiple Plate)
SM2-507 (2' x 2' lay in)
SM2N-507 (2' x 2' nail up)
SM4-507 (2' x 4' nail up)

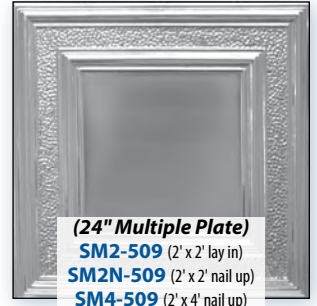

(24" Multiple Plate)
SM2-509 (2' x 2' lay in)
SM2N-509 (2' x 2' nail up)
SM4-509 (2' x 4' nail up)

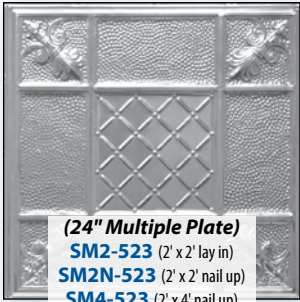

(24" Multiple Plate)
SM2-523 (2' x 2' lay in)
SM2N-523 (2' x 2' nail up)
SM4-523 (2' x 4' nail up)

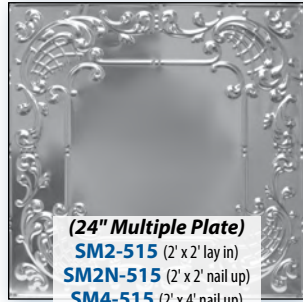

(24" Multiple Plate)
SM2-515 (2' x 2' lay in)
SM2N-515 (2' x 2' nail up)
SM4-515 (2' x 4' nail up)

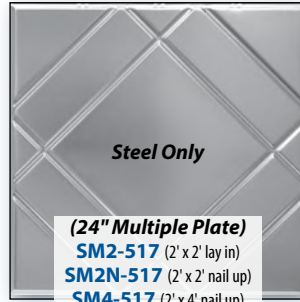

(24" Multiple Plate)
SM2-517 (2' x 2' lay in)
SM2N-517 (2' x 2' nail up)
SM4-517 (2' x 4' nail up)

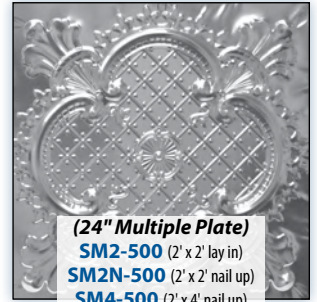

(24" Multiple Plate)
SM2-500 (2' x 2' lay in)
SM2N-500 (2' x 2' nail up)
SM4-500 (2' x 4' nail up)

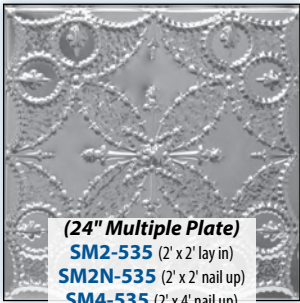

(24" Multiple Plate)
SM2-535 (2' x 2' lay in)
SM2N-535 (2' x 2' nail up)
SM4-535 (2' x 4' nail up)



CUSTOM ORDERS

If acoustics are a concern, all 2' x 2' tiles are available perforated. Please inquire for pricing and production time.

For all Powder Coated and Hand Painted Vintage finishes, please visit our website.

Fillers

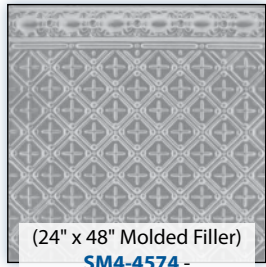

(24" x 48" Molded Filler)
SM4-4574

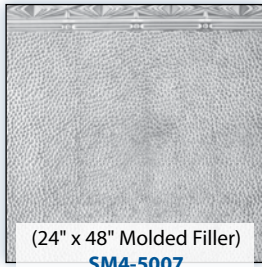

(24" x 48" Molded Filler)
SM4-5007

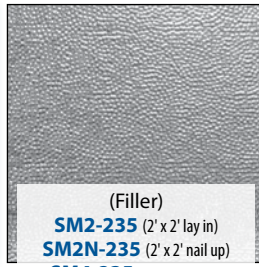

(Filler)
SM2-235 (2' x 2' lay in)
SM2N-235 (2' x 2' nail up)
SM4-235 (2' x 4' nail up)

Coffered Ceiling Tile

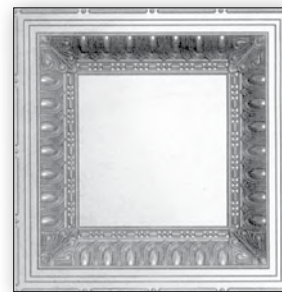

Stainless Steel Only

2' X 2' Lay-In
SM-508
 1-1/2" Deep

2' X 2' Nail Up
SM-508-N

Accessories

CONE HEAD NAILS

1-1/4" LONG
 1 LB. BOX

Coverage approx. 200 sq. ft. per box or (25) 4 ft. sections of cornice



SM-NAIL - Steel
SM-NAIL-B - Brass
SM-NAIL-C - Copper
SM-NAIL-CH - Chrome
SM-NAIL-WH - White
SM-NAIL-LAQ - Lacquered

HOLD DOWN CLIPS

200 PCS. PER BOX

SM-CLIP



Decorative Stamped Steel Cornices

All cornice mouldings are available in 4' lengths and range in projection size from 1-1/2" to 15-1/2".

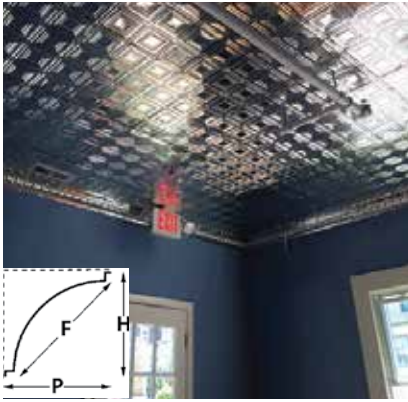

	Face (A)	Projection (B)	Height (C)
SM-804	4-1/2"	4"	4"

	Face (A)	Projection (B)	Height (C)
SM-905	7-1/4"	4"	4"

	Face (A)	Projection (B)	Height (C)
SM-707	9"	6-1/4"	6-5/8"

	Face (A)	Projection (B)	Height (C)
SM-810	2-5/8"	2"	2"

	Face (A)	Projection (B)	Height (C)
SM-705	6-1/4"	4"	4"

	Face (A)	Projection (B)	Height (C)
SM-808	11-1/4"	8-3/4"	8-3/4"

	Face (A)	Projection (B)	Height (C)
SM-803	3-1/2"	2-1/2"	2-1/2"

	Face (A)	Projection (B)	Height (C)
SM-904	9"	6"	6"

	Face (A)	Projection (B)	Height (C)
SM-807	13-1/4"	9-1/2"	9-1/2"

	Face (A)	Projection (B)	Height (C)
SM-903	3-1/2"	2-1/2"	N/A

	Face (A)	Projection (B)	Height (C)
SM-906	9-1/4"	6"	6"

	Face (A)	Projection (B)	Height (C)
SM-706	14"	9"	9"

	Face (A)	Projection (B)	Height (C)
SM-801	3-5/8"	2-1/2"	2-1/2"

	Face (A)	Projection (B)	Height (C)
SM-806	9-1/4"	6"	6"

	Face (A)	Projection (B)	Height (C)
SM-907	15-1/2"	10-1/2"	10-1/2"

	Face (A)	Projection (B)	Height (C)
SM-909	3-1/2"	3"	3"

	Face (A)	Projection (B)	Height (C)
SM-802	4-1/3"	3-1/2"	3-1/2"

Recommended paints for uncoated steel are RUST-O-LEUM to maintain the natural metal appearance, or semi or high gloss oil based primer and paint. **DO NOT USE WATER-BASED PAINT.** Chromium treated for superior paint retention and easily cleaned with soap and water.

FlexLam LITE CEILING TILES New!

2' x 2' Lay-In Patterns | Thickness: .013"



Bringing lightweight ceiling solutions to beautiful new heights! FlexLam Lite is our newest value-conscious ceiling solution. The original FlexLam Structures line has long been coveted as a durable, beautiful, and affordable option for designers and architects. With FlexLam Lite, we've successfully combined many FlexLam Lay-In Ceiling Tile patterns with 18 of our most

popular finishes into one sleek .013" thick package. This product line is ultra-lightweight, ultra-thin, easy-to-install, and even more cost-effective than our traditional FlexLam line.

The Advantage of FlexLam Lite

- Same flexibility, durability, and versatility as FlexLam Structures
- Thinner and easier to cut and fabricate
- Our most cost-effective solution for ceilings

Looking For A Drop-Out Ceiling Solution?

Our FlexLam Lite finishes in Gloss and Matte White are available as a Drop-Out Ceiling Tile, and are specifically designed to fall out when exposed to heat from a developing fire. Provide a sleek, seamless look for commercial ceilings by hiding fire sprinklers.

- Protect fire sprinklers from accidental knocks and tampering, both of which can result in water damage
- Make sprinkler system design and position easier and more cost-effective, as they completely eliminate the need to lower the sprinkler

FlexLam Lite Ceiling Tiles are not recommended for ceiling installations where temperatures exceed 120° F

Create Your Formula

FlexLam Lite offers hundreds of design and finish combinations suitable for any environment. Here's how to create your formula for success.



STEP 1: Choose Any Pattern

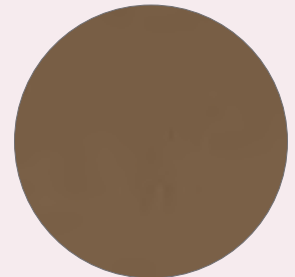

STEP 2: Choose Any Finish



FLEXLAM LITE

Shown: Georgian + Argent Bronze
= LCT22-GEO-AB



PATTERNS

2' x 2' Lay-In | Thickness: .013"



ART DECO
LCT22-ART-*



COLONIAL
LCT22-COL-*

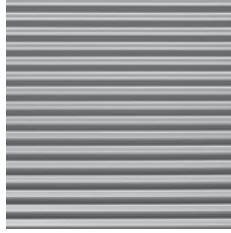

CORRUGATED
LCT22-COR-*



GEORGIAN
LCT22-GEO-*



MADISON
LCT22-MAD-*



MINERAL
LCT22-MIN



PORTRAIT
LCT22-POR-*



RAISED PANEL COFFER
LCT22-RCOF-*

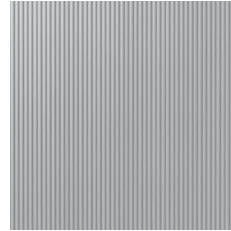

RIB 1
LCT22-RIB1-*



ROSETTE
LCT22-ROS-*

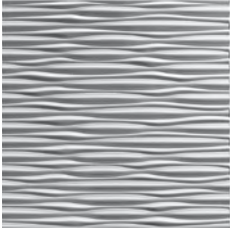

SAHARA
LCT22-SAH-*

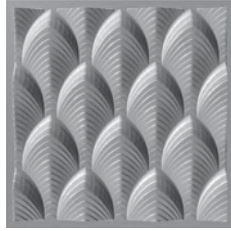

SOUTH BEACH
LCT22-SOB-*

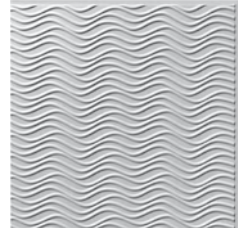

WAVATION
LCT22-WAV-*

FINISHES



ANTIQUE BRONZE
(*ANTB)



ARGENT BRONZE
(*AB)



ARGENT SILVER
(*AS)



BERMUDA BRONZE
(*BB)



BRUSHED ALUMINUM
(*BA)



BRUSHED COPPER
(*BC)



BRUSHED NICKEL
(*BN)



BRUSHED STAINLESS
(*BS)



COPPER FANTASY
(*CF)

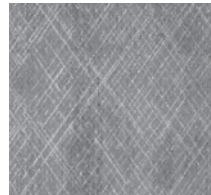

CROSSHATCH SILVER
(*CS)

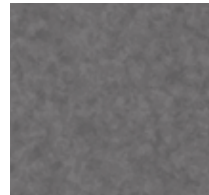

GALVANIZED
(*GAL)

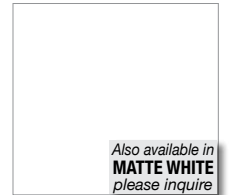

GLOSS WHITE
(*WH) Paintable

Also available in
MATTE WHITE
please inquire



MIRROR
(*M)



MIRROR GOLD
(*MIRG)



MOONSTONE COPPER
(*MC)



MUTED GOLD
(*MG)



SMOKED PEWTER
(*SP)



VINTAGE METAL
(*VM)

Considered the fifth wall in interior design, FlexLam's wide variety of ceiling tile styles and sizes can add dimension, texture, and visual interest to any room. Available in 2x2 and 2x4 sizes, for laying into suspended ceiling grid, or as a direct glue-up application, these tiles have the power to define a space.

Features:

- Compatible with 15/16" grid systems
- Lightweight & easy to install
- Waterproof
- Easy to clean
- Fire retardant
- High impact & abrasion resistant properties



Shown: Gloss White + Corrugated in Acoustic
PCT22L-PERF-COR-WH

Index

- G** **GLUE UP (2x2 Ceiling Tiles)**
Designed with an overlap system (see BIO) to make installation easy, fast and forgiving. These tiles can be used on ceilings and walls.
- G** **GLUE UP (2x4 Ceiling Tiles)**
Designed with an overlap system (see BIO) to make installation easy, fast and forgiving. These tiles can be used on ceilings and walls.
- L** **LAY-IN NON-TEGULAR (2x2 Ceiling Tiles)**
Designed to fit most suspension grid ceiling systems and produces no sag. It is recommended that a standard mineral tile (old or new) be used on top of our lay-in tiles to hold them in place.
- L** **LAY-IN NON-TEGULAR (2x4 Ceiling Tiles)**
Designed to fit most suspension grid ceiling systems and produces no sag. It is recommended that a standard mineral tile (old or new) be used on top of our lay-in tiles to hold them in place.
- T** **TEGULAR (2x2 Ceiling Tiles)**
The embossed part of the design is lower than the suspension grid and the 4 edges are flat to fit nicely into the grid.
- A** **ACOUSTIC (Perforated 2x2 Lay-In Ceiling Tiles)**
2' x 2' Lay-In tiles, perforated to increase sound absorption and offer acoustic qualities, as well as all other 2' x 2' Lay-In tile features.
Available only in Gloss Black and Gloss White
- M** **MINERAL FIBER (2x2 Lay-In Ceiling Tiles)**
Flexible mineral fiber ceiling tiles replace standard mineral fiber ceilings with a long-lasting solution. These thermoplastic ceiling tiles have a durable, waterproof surface that is easy to clean. Available in 2' x 2' for lay-in ceiling applications, this revolutionary tile is flat with tegular/revealed edges that allow the panel to drop below the grid.

BIO (Built-In-Overlap)

Our BIO has flat edges on two adjoining sides of the FlexLam Ceiling Tile. By orienting all tiles in the same direction and



overlapping the tiles, the seams are less noticeable. The placement of the tile is also more flexible so that slight imperfections in the substrate will not affect the finished look. When overlapping four FlexLam Ceiling Tiles, it is necessary to a 1/2" notch in tiles 2 and 3 to avoid a bulge where the panels meet.

Create Your Formula

FlexLam offers hundreds of design and finish combinations suitable for any environment.

Here's how to create your formula for success.



STEP 1: Choose Any Pattern

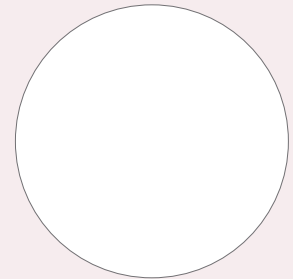

STEP 2: Choose Any Finish



FLEXLAM

Shown: Madison

+ Gloss White = PCT22G-MAD-WH

See pages S-23 ~ S-25 for patterns.
See pages S-27 ~ S-28 for color chart.

FlexLam Ceiling Tiles

2' x 2' & 2' x 4' Patterns | Thickness: .030"

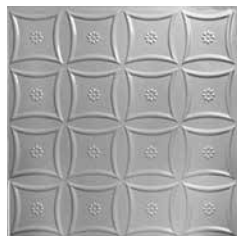

AMERICANA

PCT22G-AMER-* **G**
PCT22L-AMER-* **T A**



ART DECO

PCT24G-ART-* **G**
PCT22L-ART-* **L A**
PCT24L-ART-* **L**



BALTIMORE

PCT22G-BAL-* **G**
PCT24G-BAL-* **G**
PCT22L-BAL-* **L A**
PCT24L-BAL-* **L**

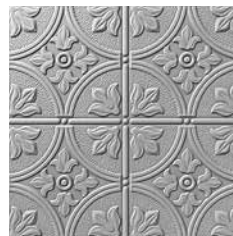

BOSTON

PCT22G-BOS-* **G**
PCT24G-BOS-* **G**
PCT22L-BOS-* **L A**
PCT24L-BOS-* **L**

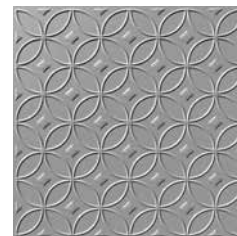

CELESTIAL

PCT22G-CEL-* **G**
PCT22L-CEL-* **T A**

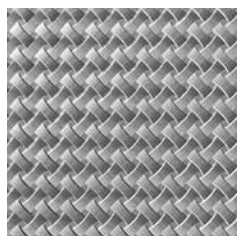

CELTIC WEAVE

PCT22G-CW-* **G**
PCT22L-CW-* **T A**



CHARLESTON

PCT24G-CHA-* **G**
PCT22L-CHA-* **L A**
PCT24L-CHA-* **L**

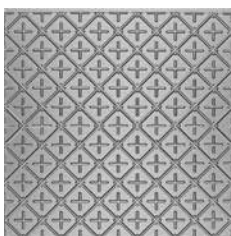

CHESAPEAKE

PCT22G-CHE-* **G**
PCT22L-CHE-* **T A**



COLONIAL

PCT22G-COL-* **G**
PCT22L-COL-* **T A**

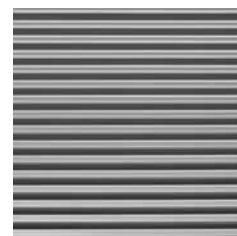

CORRUGATED

PCT22L-COR-* **T A**

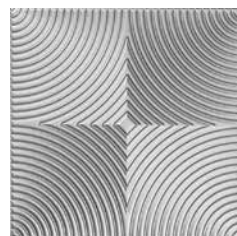

CURVATION

PCT22G-CURVA-* **G**
PCT22L-CURVA-* **T A**

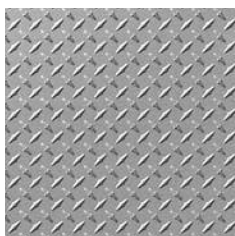

DIAMOND PLATE

PCT22L-DP-* **L A**
PCT24L-DP-* **L**



DOGWOOD

PCT22G-DOG-* **G**
PCT22L-DOG-* **T A**

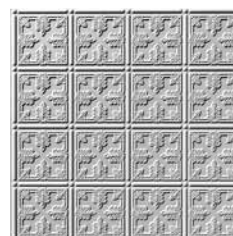

FLEUR

PCT24G-FL-* **G**
PCT22L-FL-* **L A**
PCT24L-FL-* **L**



GEORGIAN

PCT22G-GEO-* **G**
PCT22L-GEO-* **T A**

* See pages S-27 ~ S-28 for color chart.

G GLUE UP (2x2 Ceiling Tiles) **G** GLUE UP (2x4 Ceiling Tiles) **L** LAY-IN NON-TEGULAR (2x2 Ceiling Tiles) **L** LAY-IN NON-TEGULAR (2x4 Ceiling Tiles) **T** TEGULAR (2x2 Ceiling Tiles) **A** ACOUSTIC (Perforated 2x2 Lay-In Ceiling Tiles)

See page S-22 for full type descriptions. | Patterns represent a 2' x 2' section.

2' x 2' & 2' x 4' Patterns | Thickness: .030"



HURRICANE

PCT22G-HUR-* **G**
PCT22L-HUR-* **T A**



INSET COFFER

PCT22L-ICOF-* **T A**



MADISON

PCT24G-MAD-* **G**
PCT22L-MAD-* **T A**
PCT24L-MAD-* **L**

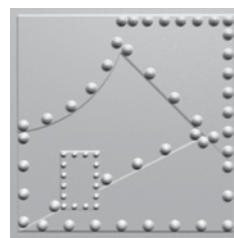

METAL PLATES

PCT22L-MP-* **T A**

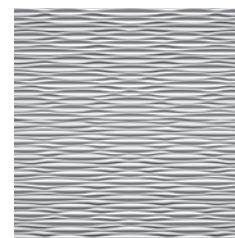

MOJAVE

PCT22G-MOJ-* **G**
PCT22L-MOJ-* **T A**

New!



PLAIN (Tegular Lay-In)

PCT22L-PLAIN-WH **T**



PORTRAIT

PCT24G-POR-* **G**
PCT22L-POR-* **L**
PCT24L-POR-* **L**



RAISED PANEL COFFER

PCT22L-RCOF-* **T A**



REGALIA

PCT22L-REGAL-* **L A**
PCT24L-REGAL-* **L**



ROSETTE

PCT24G-ROS-* **G**
PCT22L-ROS-* **T A**
PCT24L-ROS-* **L**



SAHARA

PCT22G-SAH-* **G**
PCT22L-SAH-* **T A**

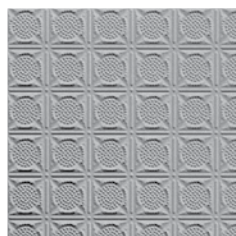

SAN DIEGO

PCT24G-SD-* **G**
PCT22L-SD-* **L A**
PCT24L-SD-* **L**

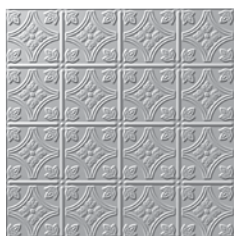

SAVANNAH

PCT22G-SAV-* **G**
PCT24G-SAV-* **G**
PCT22L-SAV-* **L A**
PCT24L-SAV-* **L**

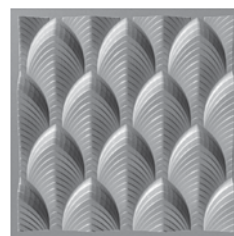

SOUTH BEACH

PCT22G-SOB-* **G**
PCT22L-SOB-* **T A**

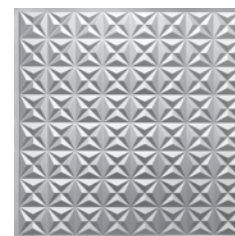

STAR

PCT22G-STAR-* **G**
PCT22L-STAR-* **T A**

* See pages S-27 ~ S-28 for color chart.

G GLUE UP (2x2 Ceiling Tiles) **G** GLUE UP (2x4 Ceiling Tiles) **L** LAY-IN NON-TEGULAR (2x2 Ceiling Tiles) **L** LAY-IN NON-TEGULAR (2x4 Ceiling Tiles) **T** TEGULAR (2x2 Ceiling Tiles) **A** ACOUSTIC (Perforated 2x2 Lay-In Ceiling Tiles)

See page S-22 for full type descriptions. | Patterns represent a 2' x 2' section.

FlexLam Ceiling Tiles

2' x 2' & 2' x 4' Patterns | Thickness: .030"

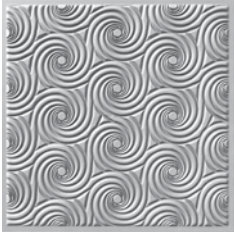

STORM

PCT22G-STO-*



PCT22L-STO-*



STRIKE

PCT22G-HAM-*



PCT24G-HAM-*



PCT22L-HAM-*



PCT24L-HAM-*

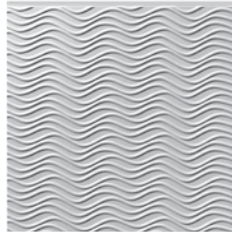

WAVATION

PCT22G-WAV-*



PCT22L-WAV-*



PCT24L-WAV-*



*Finish

White (*WH)
Argent Bronze (*AB)
Argent Copper (*AC)
Argent Gold (*AG)
Argent Silver (*AS)
Eccoflex Black (*EB)
Eccoflex Tan (*ET)
Mirror (*M)
Mirror Gold (*MIRG)
All Other Finishes

Add finish code to end of part number
ex: PCT22G-AMER-EB

* See pages S-27 ~ S-28 for color chart.



GLUE UP
(2x2 Ceiling Tiles)



GLUE UP
(2x4 Ceiling Tiles)



LAY-IN
NON-TEGULAR
(2x2 Ceiling Tiles)



LAY-IN
NON-TEGULAR
(2x4 Ceiling Tiles)



TEGULAR
(2x2 Ceiling Tiles)



ACOUSTIC
(Perforated 2x2 Lay-In Ceiling Tiles)

See page S-22 for full type descriptions. | Patterns represent a 2' x 2' section.



MINERAL

PCT22L-MIN



M MINERAL
(2x2 Lay-In Ceiling Tiles)

See page S-22 for full
type descriptions



**THIS PAGE LEFT
INTENTIONALLY
BLANK**

FlexLam FINISHES

Argent Finishes have color throughout and a metallic luster. Request physical samples as printed images may not be accurate.

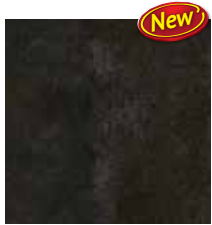

ABSTRACT BRONZE
(*ABS B)

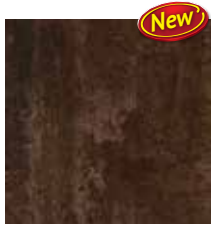

ABSTRACT COPPER
(*ABS C)

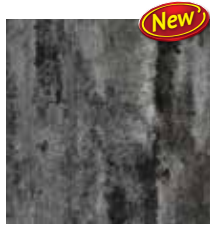

ABSTRACT SILVER
(*ABS S)



AFRICAN CHERRY
(*AFCH)



ALMOND
(*AL)



AMERICAN WALNUT
(*AMW)



ANTIQUE BRONZE
(*ANTB)



ARGENT BRONZE
(*AB)



ARGENT SILVER
(*AS)



BERMUDA BRONZE
(*BB)



BRONZE FANTASY
(*BF)

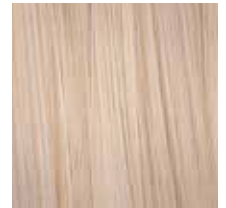

BRONZE STRATA
(*BRSTR)



BRUSHED ALUMINUM
(*BA)



BRUSHED COPPER
(*BC)



BRUSHED NICKEL
(*BN)



BRUSHED ONYX
(*BO)



BRUSHED STAINLESS
(*BS)



CASHMERE MELODY
(*CASH)



COPPER FANTASY
(*CF)



CRACKED COPPER
(*CC)



CROSSHATCH SILVER
(*CS)

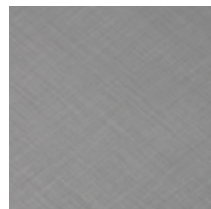

DIAMOND BRUSHED
(*DB)



DISTRESSED WHITE
(*DW)

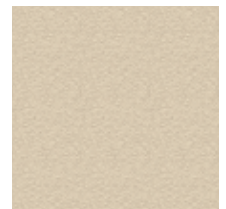

ECCOFLEX TAN
(*ET) Paintable



■ Available Colors for Linear Collection

⊕ Available Colors for Gridmax™ and Outlet Covers

➤ Available Colors for Trims (Minimums Apply)

👤 High Traffic Finishes have color throughout so scratches are less visible

* Now Available Tuffcote™ on selected finishes. A revolutionary protection shield that offers superior durability and scratch resistance.

FlexLam FINISHES

Argent Finishes have color throughout and a metallic luster. Request physical samples as printed images may not be accurate.

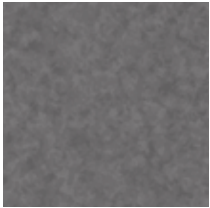

GALVANIZED
(*GAL)

+ > * ■



GLOSS BLACK
(*BK)

■

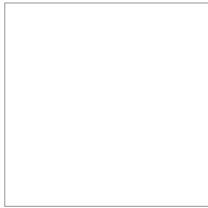

GLOSS WHITE
(*WH) *Paintable*

+ > ■

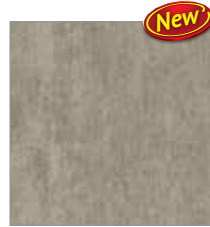

LATTE
(*LAT)

■



LIGHT MAPLE
(*LM)

■



LINEN BEIGE
(*LINB)

*



LINEN CHOCOLATE
(*LC)

*

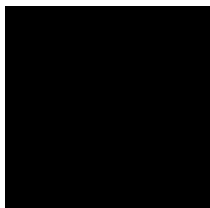

MATTE BLACK
(*MB)

■



MATTE WHITE
(*MW) *Paintable*

+ > ■



MIRROR
(*M)

■



MIRROR GOLD
(*MIRG)

■

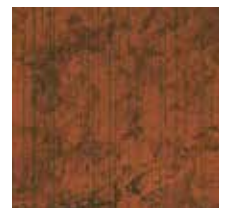

MOONSTONE COPPER
(*MC)

+ > *



MUTED GOLD
(*MG)

+ > *



OIL RUBBED BRONZE
(*ORB)

+ > * ■



OREGON ASH
(*OA)

■



PEARWOOD
(*PW)

■

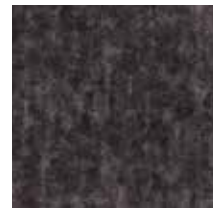

SMOKED PEWTER
(*SP)

+ > * ■



STEEL STRATA
(*STSTR)

■



TRAVERTINE
(*TRA)

*



VINTAGE METAL
(*VM)

* ■



WASHED OAK
(*WO)

■



WELSH CHERRY
(*WC)

>

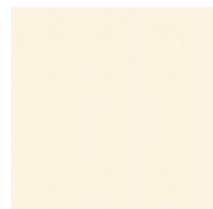

WINTER WHITE
(*WW)

⊙ > ■

■ Available Colors for Linear Collection

+ Available Colors for Gridmax™ and Outlet Covers

> Available Colors for Trims (Minimums Apply)

⊙ High Traffic Finishes have color throughout so scratches are less visible

* Now Available Tuffcote™ on selected finishes. A revolutionary protection shield that offers superior durability and scratch resistance.



STEP 1: *Choose Any Pattern*

+

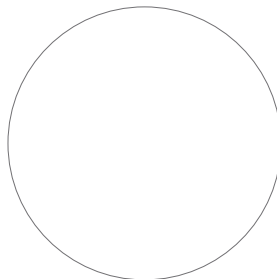

STEP 2: *Choose Any Finish*

=



FLEXLAM

Shown: Baltimore + Paintable = PCT22L-BAL-WH

See pages S-23 ~ S-25 for patterns. See pages S-27 ~ S-28 for color chart.



STEP 1: *Choose Any Pattern*

+



STEP 2: *Choose Any Finish*

=



FLEXLAM

Shown: Georgian + Argent Bronze = PCT22L-GEO-AB

See pages S-23 ~ S-25 for patterns. See pages S-27 ~ S-28 for color chart.



STEP 1: *Choose Any Pattern*

+

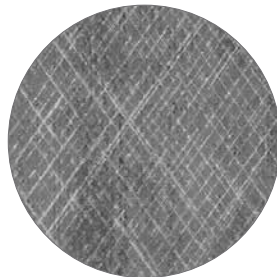

STEP 2: *Choose Any Finish*

=



FLEXLAM

Shown: Corrugated + Crosshatch Silver = PCT22L-COR-CS

See pages S-23 ~ S-25 for patterns. See pages S-27 ~ S-28 for color chart.



Laminated Rigid Vinyl Ceiling Tiles

2 Ft. x 2 Ft.

.030" Thick Drop In, Glue or Staple Up Tiles (1" T-bar grid required for drop in)

Available in White/Paintable (*WTP), Tin/Pewter (*PBR), Copper (*CBR), or Bronze (*BBR)
Please specify color code

Enjoy a magnificent antique ceiling. Create the look of historical pressed metal for a fraction of the time and price.

Better Than Tin Ceiling Tiles!

Decorative reproductions of classic tin styles that turn any ceiling into a work of art.



Alexander Style



- ❖ Remarkable Value
- ❖ Versatility
- ❖ Certified for "Air Quality" and "Children & Schools"
- ❖ FDA compliant
- ❖ **Class A Fire Rated**

DISCONTINUED
PLEASE CALL ONE OF OUR SALES ASSOCIATES FOR OTHER OPTIONS

- Won't absorb moisture or stain
- Won't harbor dust, mold or mildew
- Easy to install
- Full tile samples available at no charge (please inquire)



Fleur-De-lis Style



Laminated Rigid Vinyl Ceiling Tiles

2 Ft. x 2 Ft.

.030" Thick Drop In, Glue or Staple Up Tiles (1" T-bar grid required for drop in)

Available in White/Paintable (*WTP), Tin/Pewter (*PBR), Copper (*CBR), or Bronze (*BBR)

Please specify color code

Stock Styles Available:

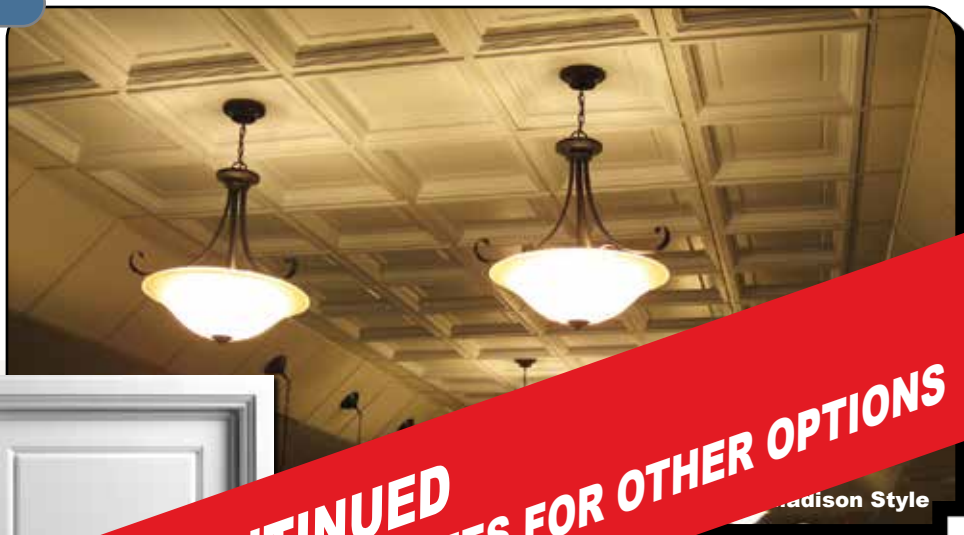

Free Shipping applies to
orders of 25 or more tiles.
Order by 12:00 PM for next
business day shipping.

Offered
Recommended 5" clearance)
(shown in White)



V3-CONT-22-*
Continental ■ ▲
(shown in Tin)

V3-ALEX-22-*
Alexander
(shown in White)

V3-FLEUR-22-*
Fleur-De-Lis ■ ▲
(shown in Copper)

V3-CAMB-22-*
Cambridge
(shown in Tin)
Available In 2' x 4'; Please Inquire

V3-EVANG-22-*
Evangeline
(shown in Bronze)

- Great for full-ceiling direct use, and as border tiles in drop ceiling applications.
- ▲ This tile may be trimmed and installed along ceiling borders.

A BROKEN BOX FEE APPLIES FOR ORDERS UNDER 25 PCS.

DISCONTINUED
PLEASE CALL ONE OF OUR SALES ASSOCIATES FOR OTHER OPTIONS



Laminated Rigid Vinyl Ceiling Tiles

2 Ft. x 2 Ft.

.030" Thick Drop In, Glue or Staple Up Tiles (1" T-bar grid required for drop in)

Available in White/Paintable (*WTP), Tin/Pewter (*PBR), Copper (*CBR), or Bronze (*BBR)

Please specify color code

Decorative Tape & Strip



Decorative Grid Tape

1" x 100' rolls.
Approximately 1 roll per 20 tiles.
Grid mount installation only.



Decorative Strip

1" x 2' strips.
Approximately 1 case per 10 tiles.
Sold in full cases (25 per case).



Part #	Finish
AC-DECOTAPE-WTP	White
AC-DECOTAPE-*	Others

Part #	Finish
V3-DECOSTRP-WTP	White
V3-DECOSTRP-*	Others

Stock Styles Available:



V3-BENT-*

V3-AVAL-*

V3-BELLA-*



Empire
shown in White

Jackson
shown in Bronze

V3-EMP-*

V3-JACK-*



Rattan ■▲
shown in Copper

Bistro
shown in Copper

V3-RAT-*

V3-BISTRO-*

Free Shipping applies for orders of 25 or more tiles. Orders over 150 tiles, call for pricing.

- Great for full-ceiling direct use, and as border tiles in drop ceiling applications.
 - ▲ This tile may be trimmed and installed along ceiling borders.
- A BROKEN BOX FEE APPLIES FOR ORDERS UNDER 25 PCS.



Jackson Style

DISCONTINUED
PLEASE CALL ONE OF OUR SALES ASSOCIATES FOR OTHER OPTIONS

FlexLam Light Diffusers

FlexLam Light Diffusers are designed to replace existing prismatic panels in suspended ceiling systems. Our diffusers are ideal for office work environments because the light is directed from side to side and does not shine downward onto computer stations.

The panels are tegular which means the embossed part of the design is lower than the suspension grid and the 4 edges are flat to fit nicely into the grid.

2' x 4' Sheets

(23-5/8" x 46-1/2")
Tolerance +/- 1/4"

**.030"
Thickness**

- Thermoplastic Panels
- Finish: Frosted Clear
- **Class A Fire Rated**
- 30% more light at eye level.
- Brighter light around perimeter.
- Softer light at desk height.
- Lightweight approximately 1.17 lbs each.

APPLICATIONS:

- Offices
- Hallways
- Schools
- Homes
- Medical Facilities



**3 Contemporary designs
to choose from!
4 pc Minimum**

**PATENT
Pending**

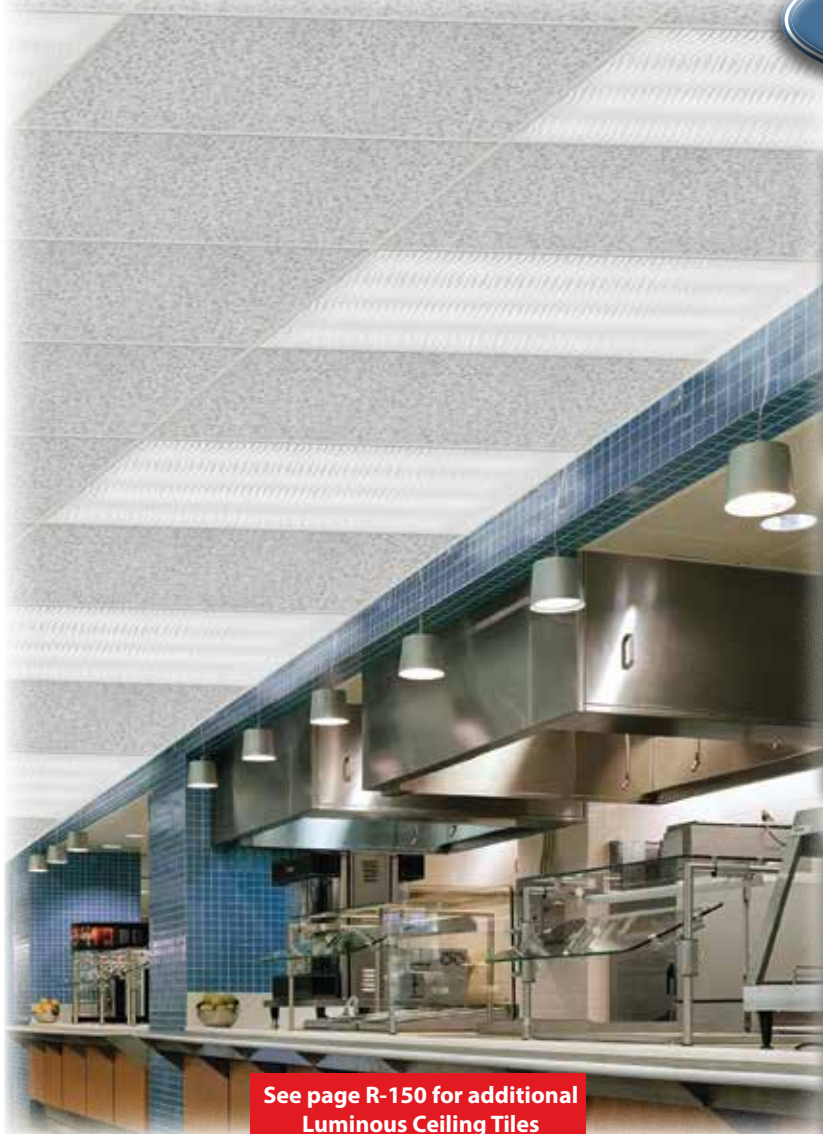

Wavation: LD24-WAV-FC

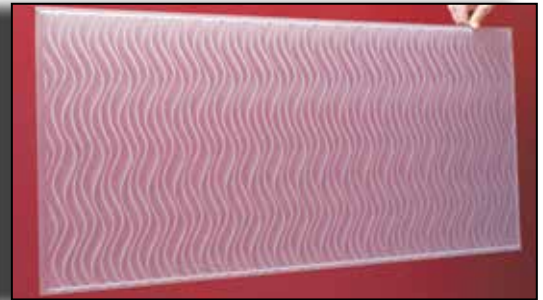

Basketweave: LD24-BAS-FC



Revolution: LD24-REV-FC



**See page R-150 for additional
Luminous Ceiling Tiles**

Smooth Ceiling Ornaments

Manufactured of high density polyurethane, these plaster-like decorative ornaments are lightweight, primed and ready to paint.



DSA-109
5" Dia.
3/4" Depth



SHOWN:
DSA-165, DSA-167

DSA-165
10" H x 16" W
5/8" Depth

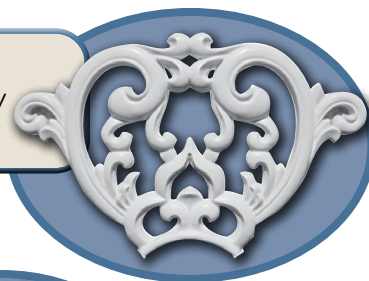

DSA-167
8-1/4" O.H. x
6-5/8" Cen. H. x
16-3/4" W
7/8" Depth



DSA-154
12-1/4" H x 9" W
1-1/4" Depth



DSA-159
13" H x 8-1/2" W
1-1/4" Depth



SHOWN:
DSA-154,
DSA-159,
DSA-109

DSA-162
26" H x 21-1/8" W
1-1/4" Depth



❖ To See Our Full Line
See Pages L-87~90 ❖



Ceiling Corner



DSA-170
18-1/4" H x 18-1/4" W
2-1/4" Depth

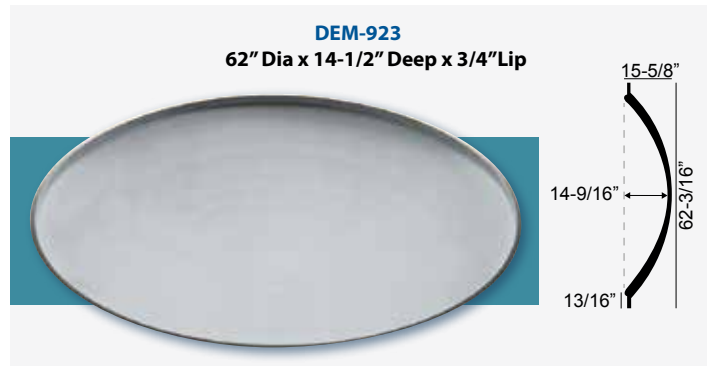

The FRT PRE-PAID offer does NOT apply to the DEM-900 Series of ceiling domes.

All dimensions are approximate.

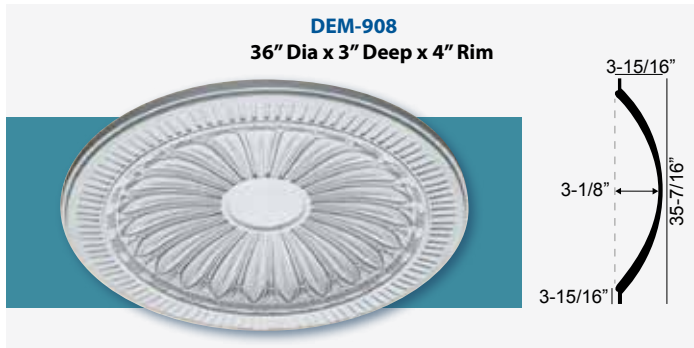

Surface Mount Ceiling Domes



The FRT PRE-PAID offer does NOT apply to the DEM-900 Series of ceiling domes.

All dimensions are approximate.

Ceiling Medallions

*For a complete line
see pages T-50~54,
T-91~94, T-101*

