

# POWDER COATED WROUGHT IRON ELEMENTS

*Reviving the Splendor of Wrought Iron*

**For Use With Our Wood Railings & Accessories** *see pgs. W-9-12*

**Satin Black (SB)**



A smooth dull finish with a hint of gloss.

**Antique Nickel (AN)**



A hand rubbed marbled effect with the look of aged nickel. Each piece will vary.

**Copper Vein (CV)**



Brown, copper and black blended with a light texture.

**Oil Rubbed Bronze (ORB)**



An aged bronze finish in a dark, deep chocolate brown with copper undertones. Each piece will vary.

**Oil Rubbed Copper (ORC)**



A blackened background that is handrubbed revealing hints of copper around the edges.



**SHOWN: PCB-256-ORC, PCB-257-ORC, PCB-263-ORC, WNP-110-RO, WHR-7011-RO, WHR-6010-BM-RO**

*Create Looks of Distinction Using our Powder Coated Iron*

# Classic Collection

## 1/2" X 44" H SQUARE PLAIN BAR TWIST BALUSTERS

<p>PCNP-108-*</p> <p><b>NEWEL POST</b></p> <p>11-1/2"</p>	<p>PCB-238-*</p> <p>22"</p>	<p>PCB-239-*</p> <p>6"</p>	<p>PCB-240-*</p> <p>6"</p>	<p>PCNP-109-*</p> <p><b>NEWEL POST</b></p> <p>7"</p> <p>9"</p> <p>7"</p>	<p>PCB-241-*</p> <p>6"</p> <p>5-1/2"</p> <p>6"</p>	<p>PCB-242-*</p> <p>9"</p>
<p>1-3/16" Sq. 48" Height 1 per box Wt. 18 lbs. per piece</p>	<p>1/2" 15 per box Wt. 3 lbs. per piece</p>	<p>1/2" 15 per box Wt. 3 lbs. per piece</p>	<p>1/2" 15 per box Wt. 3 lbs. per piece</p>	<p>1-3/16" Sq. 48" Height 1 per box Wt. 20 lbs. per piece</p>	<p>1/2" 10 per box Wt. 4 lbs. per piece</p>	<p>1/2" 10 per box Wt. 4 lbs. per piece</p>



Shown:  
PCB-239-SB  
PCB-240-SB  
PCB-251-SB

**Combination Orders:** Receive a 10% discount on combined orders of our **STOCKED** powder coated iron and Oak Hand Rails, Fitting or Newels on orders totaling \$250.00 or more.

### Stocked Finishes: Immediate Shipping



Satin Black  
(\*SB)



Copper Vein  
(\*CV)



Oil Rubbed  
Bronze (\*ORB)

### Non-Stocked Finishes:

Ships within 3-5 business days



Antique Nickel  
(\*AN)



Oil Rubbed  
Copper (\*ORC)

Add color code to the end of each part number when ordering (ex: PCNP-108-SB)

### POWDER COATED SHOES



PCSH-305-  
1/2" Square Opening  
(with Set Screw)  
50 per box  
Wt. .05 lbs. per pc.



PCSH-306-  
1/2" Square Opening  
(Pitch Shoe with Set Screw)  
50 per box  
Wt. .10 lbs. per pc.

When less than carton quantities are purchased, a broken box charge will be applied.

Powder Coated Color  
Samples Available  
Please Specify Color Choice

# Classic Collection

## 1/2" X 44" H SQUARE PLAIN BAR BALUSTERS

**PCNP-111\***

**NEWEL POST**



5"

1-3/16" Square  
48" Height  
1 per box  
Wt. 20 lbs.  
per piece

**PCB-255\***



18"

2"

10 per box  
Wt. 4 lbs.  
per piece

**PCB-256\***



20"

10 per box  
Wt. 3.5 lbs.  
per piece

**PCB-257\***



15 per box  
Wt. 3 lbs.  
per piece

**PCB-258\***



2"

2"

10 per box  
Wt. 4 lbs.  
per piece



Shown:  
PCB-256-SB, PCB-251-SB,  
WHR-6010-BM-RO &  
WHR-6010-RO

**Combination Orders:** Receive a 10% discount on combined orders of our **STOCKED** powder coated iron and Oak Hand Rails, Fitting or Newels on orders totaling \$250.00 or more.

### Stocked Finishes: Immediate Shipping



Satin Black  
(\*SB)



Oil Rubbed  
Bronze (\*ORB)

### Non-Stocked Finishes:

Ships within 3-5 business days

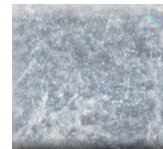

Antique Nickel  
(\*AN)



Oil Rubbed  
Copper (\*ORC)

Add color code to the end of each part number when ordering (ex: PCNP-111-SB)

### POWDER COATED SHOES



**PCSH-305\***  
1/2" Square Opening  
(with Set Screw)  
50 per box  
Wt. .05 lbs. per pc.



**PCSH-306\***  
1/2" Square Opening  
(Pitch Shoe with Set Screw)  
50 per box  
Wt. .10 lbs. per pc.

When less than carton quantities are purchased, a broken box charge will be applied.

Powder Coated Color  
Samples Available  
Please Specify Color Choice



# Classic Collection

## 1/2" SQUARE PLAIN BAR BALUSTERS

## 9/16" X 44" H ROUND HAND FORGED BALUSTERS

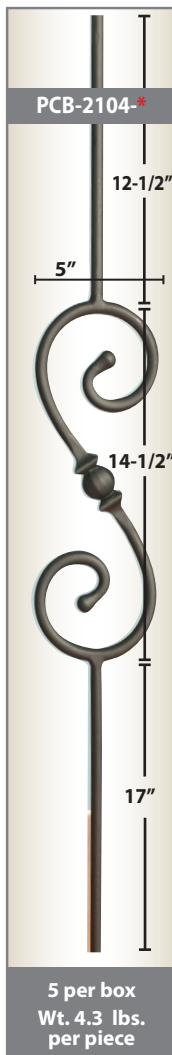

**Stocked  
Finishes:**  
Immediate  
Shipping

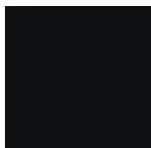

Satin Black  
(\*SB)



Oil Rubbed  
Bronze (\*ORB)

**Non-Stocked  
Finishes:**  
Ships within 3-5  
business days

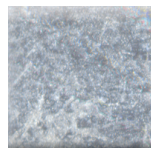

Antique Nickel  
(\*AN)



Oil Rubbed  
Copper (\*ORC)

When less than carton quantities are purchased, a \$5.00 broken box charge will be applied.

### SQUARE POWDER COATED SHOES



**PCSH-305-\***  
1/2" Square Opening  
(with Set Screw)  
50 per box  
Wt. .05 lbs. per pc.



**PCSH-306-\***  
1/2" Square Opening  
(Pitch Shoe with Set Screw)  
50 per box  
Wt. .10 lbs. per pc.

Powder Coated Color  
Samples Available  
Please Specify Color Choice

**Combination Orders:** Receive a 10% discount on combined orders of our  
**STOCKED** powder coated iron and Oak Hand Rails, Fitting or Newels on orders  
totaling \$250.00 or more.

Add color code to the end of each part  
number when ordering (ex: PCB-251-SB)

### ROUND POWDER COATED SHOES



**PCSH-302-\***  
9/16" Rd. Opening  
50 per box  
Wt. .05 lbs. per pc.



**PCSH-303-\***  
9/16" Rd. Opening  
(Pitch Shoe with Set Screw)  
50 per box  
Wt. .10 lbs. per pc.





# Bold Collection

## 3/4" X 44" H SQUARE TUBE BALUSTERS

<p>PCB-239B34-*</p>	<p>PCB-240B34-*</p>	<p>PCB-241B34-*</p>	<p>PCB-242B34-*</p>	<p>PCB-255B34-*</p>	<p>PCB-256B34-*</p>	<p>PCB-257B34-*</p>
<p>3/4" Sq. 10 per box Wt. 1.6 lbs. per piece</p>	<p>3/4" Sq. 10 per box Wt. 1.5 lbs. per piece</p>	<p>3/4" Sq. 10 per box Wt. 3 lbs. per piece</p>	<p>3/4" Sq. 10 per box Wt. 3 lbs. per piece</p>	<p>3/4" Sq. 10 per box Wt. 2 lbs. per piece</p>	<p>3/4" Sq. 10 per box Wt. 2.2 lbs. per piece</p>	<p>3/4" Sq. 10 per box Wt. 1.6 lbs. per piece</p>

**Stocked Finishes:**  
Immediate Shipping

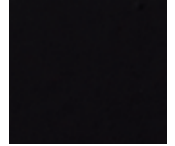

Satin Black  
(\*SB)



Oil Rubbed  
Bronze (\*ORB)



Graphite Gray  
(\*GR)

**Powder  
Coated  
Color  
Samples  
Available**  
Please Specify  
Color Choice

Add color code to the end of each part number when ordering (ex: PCB-239B34-SB)

**Combination Orders:** Receive a 10% discount on combined orders of our STOCKED powder coated iron and Oak Hand Rails, Fitting or Newels on orders totaling \$250.00 or more.

### POWDER COATED SHOES



PCSH-313-  
3/4" Square Opening  
(with Set Screw)  
50 per box  
Wt. .05 lbs. per pc.



PCSH-314-  
3/4" Square Opening  
(Pitch Shoe with Set Screw)  
50 per box  
Wt. .10 lbs. per pc.

When less than carton quantities are purchased, a broken box charge will be applied.

# POWDER COATED WROUGHT IRON BALUSTERS & FITTINGS

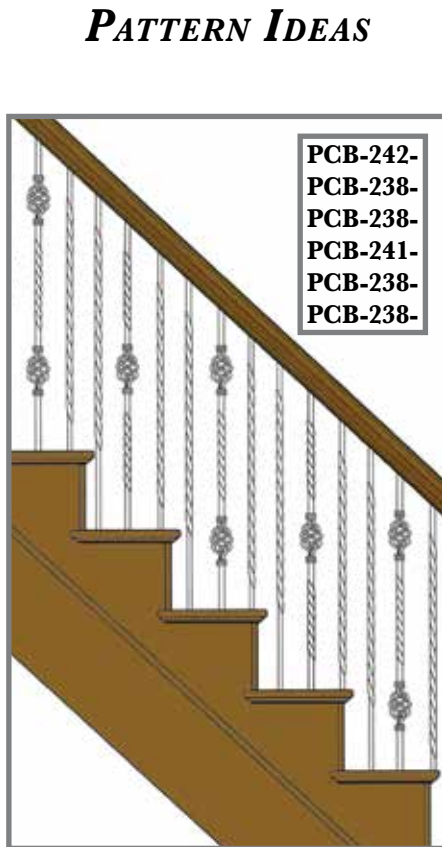
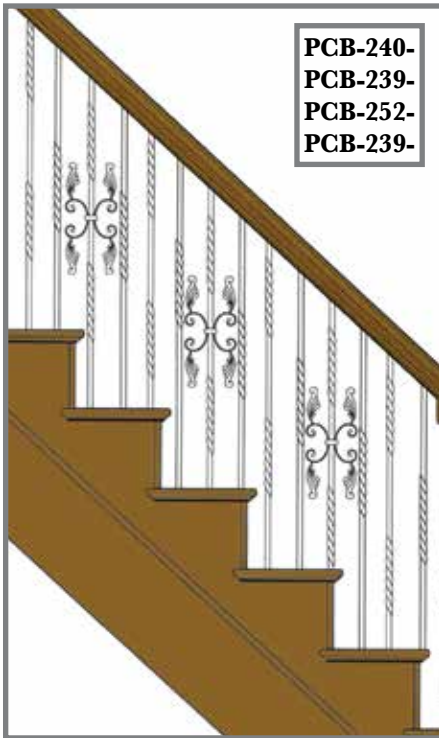

*Please consider how your design repeat will layout in a straight run if applicable.*

# POWDER COATED WROUGHT IRON BALUSTERS & FITTINGS

## PATTERN IDEAS

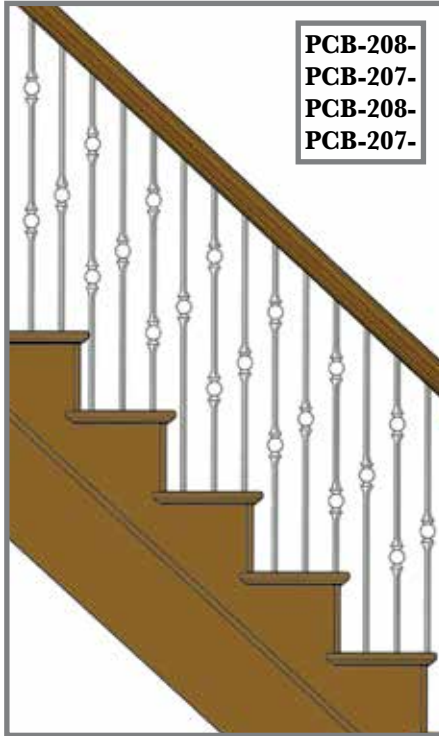
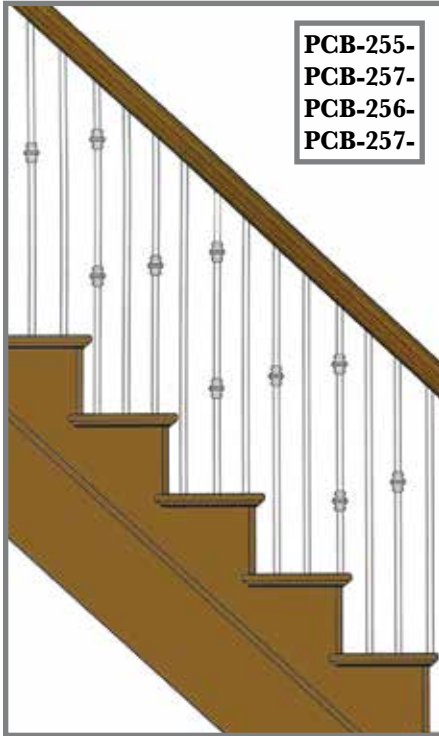

*Please consider how your design repeat will layout in a straight run if applicable.*

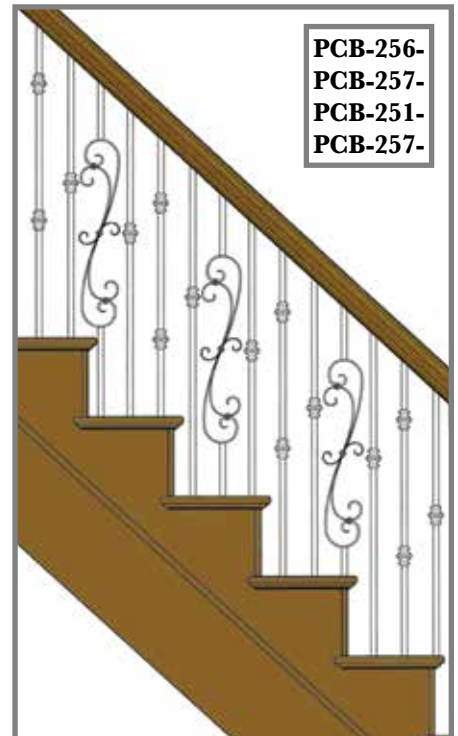
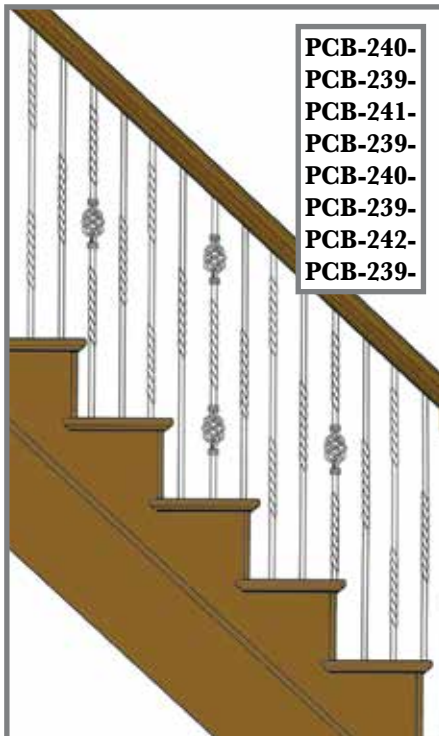
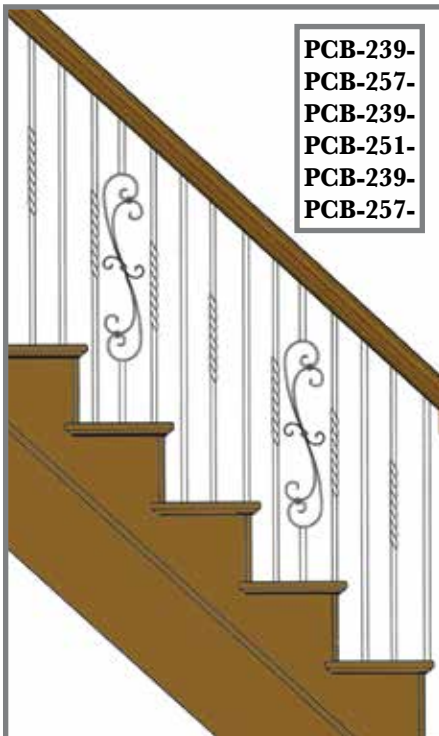





Shown In: Mahogany



Shown In: Maple

### Staircases . . .

*So much more than a means of reaching various levels in the home, they provide the opportunity to create a striking architectural focal point. Whether new construction or a remodel, consider form and not just function. With our selection of powder coated iron balusters, traditional oak hand rails, fittings & newels, create a stairway with style and character.*

### Other Species Available



**All fittings include connective hardware #RBK-WOOD kit**

Minimums & lead times may apply. Please call our sales department to submit a request for quotation.

Shown In: Red Oak



**Other Species Available**  
**See Page W-9**

*All fittings include connective hardware #RBK-WOOD kit*



**Combination Orders:**  
*Receive a 10% discount on combined orders of our **STOCKED** powder coated iron and Oak Hand Rails, Fittings or Newels on orders totaling \$250.00 or more.*

Minimums & lead times may apply.  
Please call our sales department to submit a request for quotation.





# Traditional Hand Rail & Fittings Stocked In Unfinished Red Oak



Shown In: Mahogany

**Other Species Available**

**See Page W-9**

All fittings include connective hardware #RBK-WOOD kit



**2 Rise Straight  
Gooseneck**

**WHR-7099-RO**

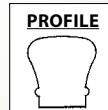

**2 Rise Left  
Hand Gooseneck**

**WHR-7071-RO**

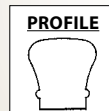

**2 Rise Right  
Hand Gooseneck**

**WHR-7076-RO**

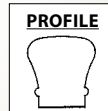

**Up Easing**

**WHR-7012-RO**

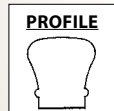

**90° Up Easing**

**WHR-7014-RO**

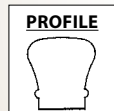

**Over Easing**

**WHR-7013-RO**

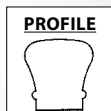

**Combination Orders:**

Receive a 10% discount on combined orders of our **STOCKED** powder coated iron and Oak Hand Rails, Fittings or Newels on orders totaling \$250.00 or more.

Minimums & lead times may apply. Please call our sales department to submit a request for quotation.

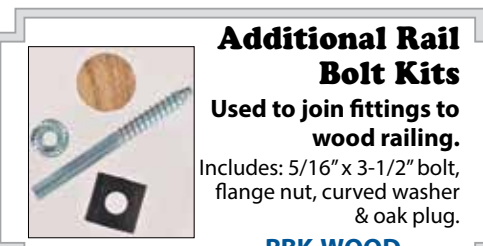

**Additional Rail  
Bolt Kits**

Used to join fittings to wood railing.

Includes: 5/16" x 3-1/2" bolt, flange nut, curved washer & oak plug.

**RBK-WOOD**



**For Use With Our Oak Hand Rail And Fittings**

**BOX NEWEL**

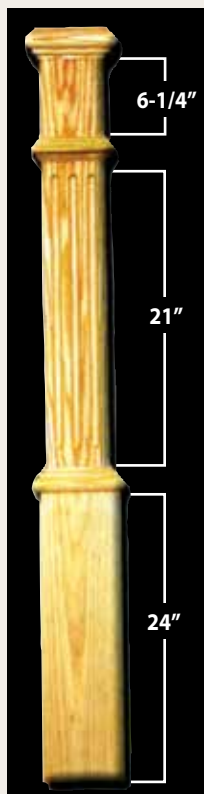

**WNP-110-RO**

RED OAK  
FLUTED  
BOX NEWEL  
6-1/4" x 6-1/4"  
56"

**TURNED NEWEL**

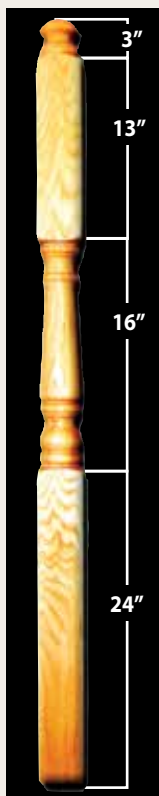

**WNP-104-RO**

RED OAK  
3-1/2" x 3-1/2"  
56"



**PIN TOP SUPPORT NEWEL**

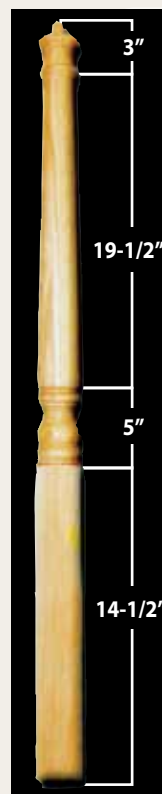

**WNP-100-RO**

RED OAK  
3" x 3"  
42"



**Combination Orders:** Receive a 10% discount on combined orders of our **STOCKED** powder coated iron and Oak Hand Rails, Fittings or Newels on orders totaling \$250.00 or more

# BALUSTERS

Available in Maple, White Oak and Cherry



**HWBAL-LACN-MP**  
(Maple)  
**HWBAL-LACN-WHO**  
(White Oak)  
**HWBAL-LACN-CH**  
(Cherry)

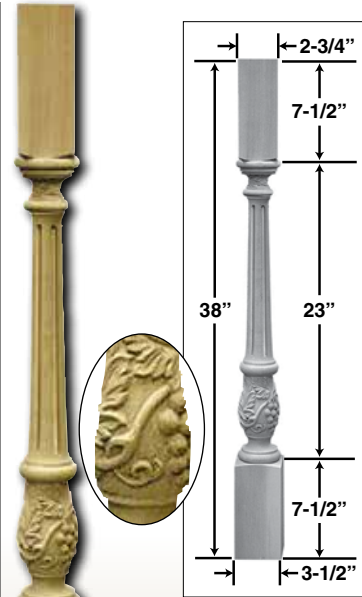

**HWBAL-LGRP-MP**  
(Maple)  
**HWBAL-LGRP-WHO**  
(White Oak)  
**HWBAL-LGRP-CH**  
(Cherry)

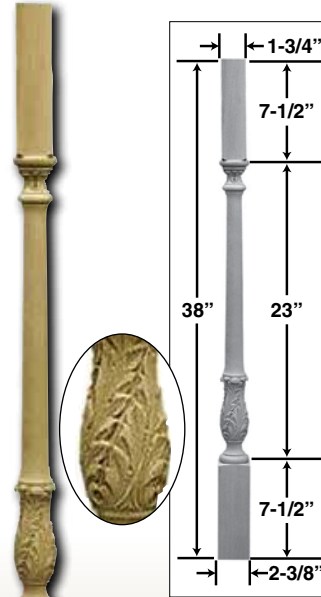

**HWBAL-SACN-MP**  
(Maple)  
**HWBAL-SACN-WHO**  
(White Oak)  
**HWBAL-SACN-CH**  
(Cherry)

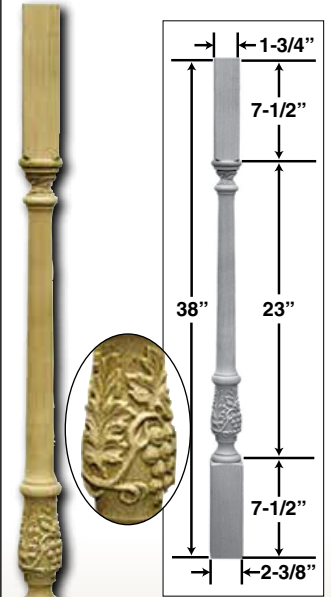

**HWBAL-SGRP-MP**  
(Maple)  
**HWBAL-SGRP-WHO**  
(White Oak)  
**HWBAL-SGRP-CH**  
(Cherry)

# NEWEL POSTS

Available in Maple, White Oak and Cherry

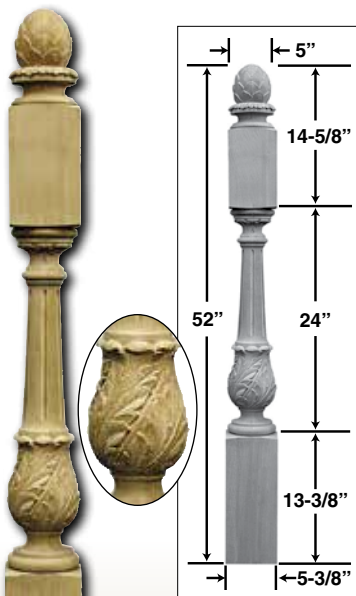

**HWNP-LACN-MP**  
(Maple)  
**HWNP-LACN-WHO**  
(White Oak)  
**HWNP-LACN-CH**  
(Cherry)

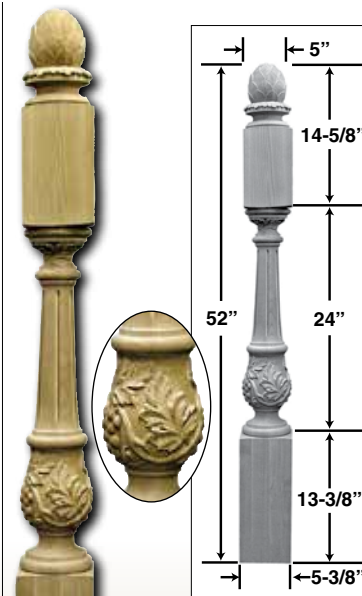

**HWNP-LGRP-MP**  
(Maple)  
**HWNP-LGRP-WHO**  
(White Oak)  
**HWNP-LGRP-CH**  
(Cherry)

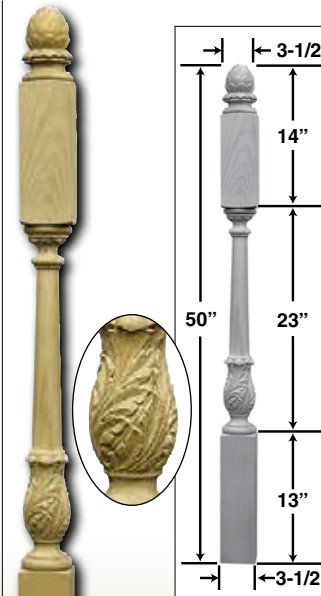

**HWNP-SACN-MP**  
(Maple)  
**HWNP-SACN-WHO**  
(White Oak)  
**HWNP-SACN-CH**  
(Cherry)

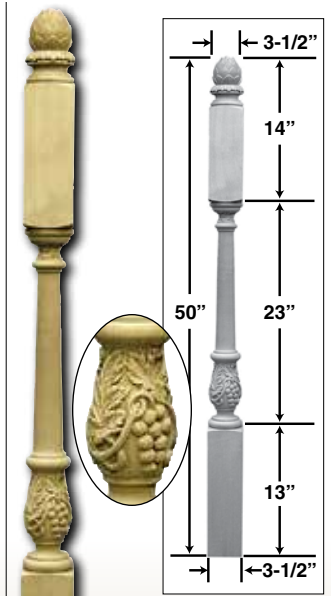

**HWNP-SGRP-MP**  
(Maple)  
**HWNP-SGRP-WHO**  
(White Oak)  
**HWNP-SGRP-CH**  
(Cherry)

# Regal Collection

## 9/16" X 44" H ROUND SMOOTH BALUSTERS

<p><b>PCNP-100-*</b></p> <p><b>NEWEL POST</b></p> <p>18-1/2"</p> <p>3"</p> <p>1-3/16" Diameter 47" Height 1 per box Wt. 18 lbs. per piece</p>	<p><b>PCB-200-*</b></p> <p>18"</p> <p>12"</p> <p>15 per box Wt. 2.7 lbs. per piece</p>	<p><b>PCB-201-*</b></p> <p>12"</p> <p>15 per box Wt. 3 lbs. per piece</p>	<p>7"</p> <p>12"</p> <p>6"</p> <p><b>PCB-202-*</b></p> <p>10 per box Wt. 4 lbs. per piece</p>	<p>7"</p> <p>15-1/2"</p> <p>5 per box Wt. 5 lbs. per piece</p>	<p><b>PCB-204-*</b></p> <p>15 per box Wt. 2.7 lbs. per piece</p>
---	--	---	---	--	--



Shown: PCB-202-SB,  
PCB-201-SB, WHR-6010-RO  
& WNP-110-RO  
(Acorn finial not included)

**Non-Stocked  
Finishes:**

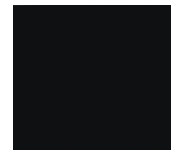

*Ships within 3-5  
business days*



**Satin Black  
(\*SB)**

Add color code to the end of each part number when ordering (ex: PCNP-100-SB)

**POWDER COATED SHOES**

 <p><b>PCSH-302-*</b>-D 9/16" Rd. Opening 50 per box Wt. .05 lbs. per pc.</p>	 <p><b>PCSH-303-*</b>-D 9/16" Rd. Opening (Pitch Shoe with Set Screw) 50 per box Wt. .10 lbs. per pc.</p>
--	--

**Powder Coated Color  
Samples Available**  
*Please Specify Color Choice*

*When less than carton quantities are purchased, a broken box charge will be applied.*



# Regal Collection

## 1/2" X 44" H SQUARE PLAIN BAR BALUSTERS

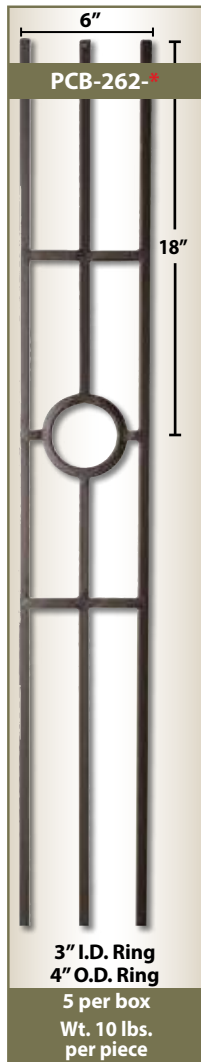

## 9/16" X 44" H SQUARE HAMMERED FLEUR DE LIS DESIGN BALUSTERS

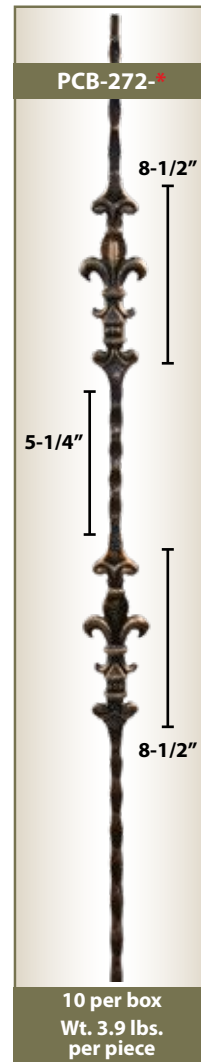

Add color code to the end of each part number when ordering (ex: PCB-260-SB)

**Non-Stocked  
Finishes:**

*Ships within 3-5  
business days*

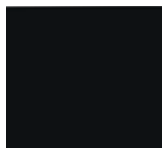

**Satin Black  
(\*SB)**



**Oil Rubbed  
Bronze (\*ORB)**



**Vintage Brass  
(\*VB)**

**Powder Coated Color  
Samples Available**

*Please Specify Color Choice*

*When less than carton quantities are purchased,  
a broken box charge will be applied.*

**POWDER COATED SHOES**



**PCSH-301-\***  
1/2" Square  
Opening  
50 per box  
Wt. .05 lbs.  
per pc.

**For 1/2" Only**



**PCSH-305-\*\*-D**  
1/2" Square  
Opening  
(with Set Screw)  
50 per box  
Wt. .05 lbs.  
per pc.



**PCSH-306-\*\*-D**  
1/2" Square  
Opening  
(Pitch Shoe with  
Set Screw)  
50 per box  
Wt. .10 lbs.  
per pc.



**PCSH-400-\***  
9/16" Square  
Opening  
(Shoe with  
Set Screw)  
50 per box  
Wt. .05 lbs.  
per pc.

**For 9/16" Only**



**PCSH-401-\***  
9/16" Square  
Opening  
(Pitch Shoe with  
Set Screw)  
50 per box  
Wt. .10 lbs.  
per pc.

# Regal Collection

## 9/16" X 44" H SQUARE HEAVY HAMMERED BALUSTERS

**PCNP-110-\***

**NEWEL POST**

1-3/16" Square  
48" Height  
1 per box  
Wt. 22 lbs.  
per piece

**PCB-244-\***

10 per box  
Wt. 3.5 lbs.  
per piece

**PCB-245-\***

10 per box  
Wt. 3.8 lbs.  
per piece

**PCB-246-\***

15 per box  
Wt. 4 lbs.  
per piece

**PCB-247-\***

15 per box  
Wt. 4-1/2" lbs.  
per piece

**Non-Stocked  
Finishes:**

*Ships within 3-5  
business days*

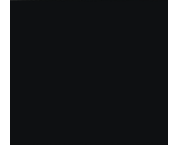

**Satin Black  
(\*SB)**



**Oil Rubbed  
Copper (\*ORC)**



**Oil Rubbed  
Bronze (\*ORB)**

**Powder  
Coated  
Color  
Samples  
Available**  
*Please Specify  
Color Choice*

Add color code to the end of each part number when ordering (ex: PCNP-110-SB)

### POWDER COATED SHOES



**PCSH-304-\***  
9/16" Square  
Opening  
(Pitch Shoe with  
Set Screw)  
50 per box  
Wt. .10 lbs. per pc.



**PCSH-307-\***  
9/16" Square  
Opening  
(Shoe with Set Screw)  
50 per box  
Wt. .05 lbs. per pc.



**PCSH-310-\***  
9/16" Square  
Opening  
50 per box  
Wt. .05 lbs. per pc.

*When less than carton quantities are purchased, a broken box charge will be applied.*

# Regal Collection

## 9/16" X 44" H SQUARE HAND FORGED BALUSTERS

<p><b>PCNP-104-*</b></p> <p><b>NEWEL POST</b></p> <p>6-1/2"</p> <p>1" Square 47" Height 1 per box Wt. 18 lbs. per piece</p>	<p><b>PCB-218-*</b></p> <p>3-7/8"</p> <p>10 per box Wt. 4 lbs. per piece</p>	<p><b>PCB-219-*</b></p> <p>21"</p> <p>10 per box Wt. 4.5 lbs. per piece</p>	<p><b>PCB-220-*</b></p> <p>15 per box Wt. 3 lbs. per piece</p>	<p><b>PCNP-105-*</b></p> <p><b>NEWEL POST</b></p> <p>7"</p> <p>1" Square 47" Height 1 per box Wt. 18 lbs. per piece</p>	<p><b>PCB-221-*</b></p> <p>5"</p> <p>10 per box Wt. 4 lbs. per piece</p>	<p><b>PCB-222-*</b></p> <p>19-1/2"</p> <p>10 per box Wt. 5.5 lbs. per piece</p>
---	--	---	--	---	--	---



Shown:  
PCB-221-ORB, PCB-222-ORB,  
WHR-6010-RO, WNP-110-RO  
(Acorn finial not included)

**Non-Stocked Finishes:**  
Ships within 3-5 business days

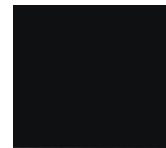

Satin Black  
(\*SB)



Oil Rubbed  
Bronze (\*ORB)

Add color code to the end of each part number when ordering (ex: PCNP-104-SB)

### POWDER COATED SHOES

<p><b>PCSH-304-*</b> 9/16" Square Opening (Pitch Shoe with Set Screw) 50 per box Wt. .10 lbs. per pc.</p>	<p><b>PCSH-307-*</b> 9/16" Square Opening (Shoe with Set Screw) 50 per box Wt. .05 lbs. per pc.</p>
---	---

**Powder Coated Color  
Samples Available**  
Please Specify Color Choice

When less than carton quantities are purchased, a broken box charge will be applied.



# Regal Collection

## 9/16" X 44" H SQUARE HAND FORGED BALUSTERS

<p><b>PCB-212-*</b></p> <p>19-3/4"</p> <p>2"</p> <p>15 per box Wt. 4 lbs. per piece</p>	<p><b>PCB-213-*</b></p> <p>19-3/4"</p> <p>27-1/2"</p> <p>10 per box Wt. 3.5 lbs. per piece</p>	<p><b>PCB-214-*</b></p> <p>6"</p> <p>10 per box Wt. 3.5 lbs. per piece</p>	<p><b>PCB-215-*</b></p> <p>6"</p> <p>6"</p> <p>10 per box Wt. 3.8 lbs. per piece</p>	<p><b>PCB-216-*</b></p> <p>6"</p> <p>10 per box Wt. 3.5 lbs. per piece</p>	<p><b>PCB-217-*</b></p> <p>6"</p> <p>6"</p> <p>10 per box Wt. 3.8 lbs. per piece</p>	<p><b>PCB-220-*</b></p> <p>15 per box Wt. 3 lbs. per piece</p>
---	--	--	--	--	--	--

Add color code to the end of each part number when ordering (ex: PCB-212-SB)

### POWDER COATED SHOES



**PCSH-304-\***  
9/16" Square  
Opening  
(Pitch Shoe with  
Set Screw)  
50 per box  
Wt. .10 lbs. per pc.



**PCSH-307-\***  
9/16" Square  
Opening  
(Shoe with Set Screw)  
50 per box  
Wt. .05 lbs. per pc.

**Powder Coated Color  
Samples Available**  
Please Specify Color Choice

### Non-Stocked Finishes:

*Ships within 3-5 business days*

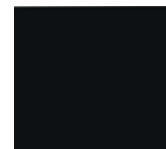

**Satin Black  
(\*SB)**



**Oil Rubbed  
Bronze (\*ORB)**

*When less than carton quantities are purchased, a broken box charge will be applied.*

# Regal Collection

## 1/2" X 44" H SQUARE PLAIN BAR RIBBON TWIST BALUSTERS

<p><b>PCNP-107-*</b></p> <p><b>NEWEL POST</b></p> <p>11-1/2"</p>	<p><b>PCB-232-*</b></p> <p>10"</p>	<p><b>PCB-233-*</b></p> <p>6"</p>	<p><b>PCB-234-*</b></p> <p>2-1/2"</p> <p>5-1/4"</p> <p>6-1/2"</p>	<p><b>PCB-235-*</b></p> <p>18"</p>	<p><b>PCB-236-*</b></p> <p>6"</p> <p>18"</p> <p>6-1/2"</p> <p>4"</p>	<p><b>PCB-237-*</b></p> <p>6"</p> <p>9-3/4"</p> <p>10-1/2"</p> <p>4"</p>
<p>1-3/16" Square 48" Height 1 per box Wt. 19 lbs. per piece</p>	<p>15 per box Wt. 3.2 lbs. per piece</p>	<p>15 per box Wt. 3 lbs. per piece</p>	<p>10 per box Wt. 3.2 lbs. per piece</p>	<p>10 per box Wt. 3.2 lbs. per piece</p>	<p>10 per box Wt. 4 lbs. per piece</p>	<p>10 per box Wt. 4 lbs. per piece</p>



Shown: PCB-232-ORC,  
PCB-236-ORC, WHR-7030-RO  
& WHR-6010-RO

**Non-Stocked Finishes:**  
Ships within 3-5 business days



Satin Black  
(\*SB)



Oil Rubbed  
Copper (\*ORC)

Add color code to the end of each part number when ordering (ex: PCNP-107-SB)

### POWDER COATED SHOES

<p><b>PCSH-301-*</b> 1/2" Square Opening 50 per box Wt. .05 lbs. per pc.</p>	<p><b>PCSH-305-*</b> 1/2" Square Opening (with Set Screw) 50 per box Wt. .05 lbs. per pc.</p>	<p><b>PCSH-306-*</b> 1/2" Square Opening (Pitch Shoe with Set Screw) 50 per box Wt. .10 lbs. per pc.</p>
<p><b>PCSH-311-*</b> 1/2" Square Opening 50 per box Wt. .5 lbs. per pc.</p>	<p><b>PCSH-312-*</b> 1/2" Square Opening 50 per box Wt. .5 lbs. per pc.</p>	

**Powder Coated Color  
Samples Available**  
Please Specify Color Choice

When less than carton quantities are purchased, a broken box charge will be applied.

# Regal Collection

## 1/2" SQUARE PLAIN BAR BALUSTERS

<b>PCB-243-*</b>	<b>PCB-248-*</b>	<b>PCB-249-*</b>	<b>PCB-250-*</b>
44" H 5 per box Wt. 8 lbs. per piece	40" H 10 per box Wt. 4 lbs. per piece	40" H 10 per box Wt. 4 lbs. per piece	40" H 10 per box Wt. 4 lbs. per piece

## 9/16" X 44" H ROUND HAND FORGED BALUSTERS

<b>PCB-205-*</b>	<b>PCB-206-*</b>	<b>PCNP-102-*</b>	<b>PCB-210-*</b>	<b>PCB-211-*</b>
9/16" 15 per box Wt. 3.5 lbs. per piece	9/16" 15 per box Wt. 4 lbs. per piece	1" Diameter 47" Height 1 per box Wt. 18 lbs. per piece	9/16" 15 per box Wt. 2.5 lbs. per piece	9/16" 15 per box Wt. 3 lbs. per piece

Add color code to the end of each part number when ordering (ex: PCNP-243-SB)

**Non-Stocked  
Finishes:**  
Ships within 3-5  
business days

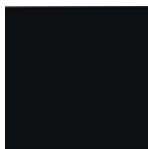

Satin Black  
(\*SB)



Oil Rubbed  
Bronze (\*ORB)

**Powder Coated Color  
Samples Available**  
Please Specify Color Choice

*When less than carton quantities are  
purchased, a broken box  
charge will be applied.*

### SQUARE POWDER COATED SHOES



**PCSH-305-<sup>-</sup>D**  
1/2" Square Opening  
(with Set Screw)  
50 per box  
Wt. .05 lbs. per pc.



**PCSH-306-<sup>-</sup>D**  
1/2" Square Opening  
(Pitch Shoe with Set Screw)  
50 per box  
Wt. .10 lbs. per pc.

### ROUND POWDER COATED SHOES



**PCSH-500-<sup>-</sup>D**  
9/16" Round Opening  
(Shoe with Set Screw)  
50 per box  
Wt. .05 lbs. per pc.



**PCSH-501-<sup>-</sup>D**  
9/16" Round Opening  
(Pitch Shoe with Set Screw)  
50 per box  
Wt. .10 lbs. per pc.



## EASY INSTALLATION *(For use with our wood rails)*



1. Check for plumb of baluster length and placement.



2. Cut baluster to length.



3. Cut round hole in bottom of handrail for baluster.



4. Square off bottom hole with air hammer/chisel and mortising bit without the drill inside. (For installation of square balusters without needing shoes)



5. Apply epoxy in hole for baluster on top.



6. Do same for bottom.



7. Install baluster into epoxy filled holes and press in for tight fit.



TOOLS USED: Standard Electric Drill, Air Hammer/Chisel, Epoxy Gun

**Powder Coated Wrought Iron and Wood Newel Posts ordered in error may be returned (Freight Pre-paid) for credit within 30 days less a 30% restocking charge.**

### EPOXY ADHESIVES FOR IRON BALUSTERS



**PCA-ENP  
EPOXY FOR  
NEWEL POSTS**  
(coverage approximately  
1 round or 2 square)



**PCA-EBAL  
EPOXY FOR  
BALUSTERS**  
(coverage approximately  
15-20 pieces)



**PCA-EG  
EPOXY GUN**

### TOUCH UP PAINT



**PCA-TUP-SB  
Satin Black \*  
Touch Up Pen**  
*\* Touch up paints  
available in Black only*



**PCA-TUC-SB  
Satin Black \*  
Touch Up Paint**

**NOTE REGARDING SHOES:** Optional shoes are often loose fitting around the balusters due to size tolerances created by the forged nature of the iron. Shoes do not secure the balusters in place, they are an optional decorative element. In addition to the set screw, a bead of epoxy can be used to secure them into place if desired.

### DESCRIPTION OF PIECES:

**Forged:** Metal that is heated then shaped by hammering.  
**Cast:** Creating a shape by pouring molten metal into a mold.  
**Edge Hammered:** Hammered on all four edges (Corners).  
**Heavily Hammered:** Hammered on all four edges and all four flat sides.

### Powder Coated Color Samples Available

\*\*\* Please Specify Color Choice \*\*\*

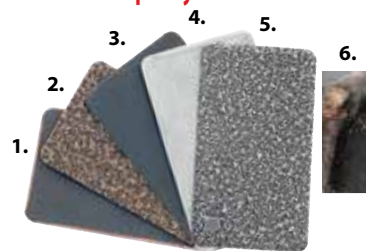

- 1. Oil Rubbed Copper** – A blackened background that is handrubbed revealing hints of copper around the edges.
- 2. Copper Vein** – Brown, copper and black blended with a light texture.
- 3. Satin Black** – A smooth dull finish with a hint of gloss.
- 4. Antique Nickel** – A hand rubbed marbled effect with the look of aged nickel. Each piece will vary.
- 5. Silver Vein** – Silver and black blended with a light texture.
- 6. Oil Rubbed Bronze** – An aged bronze finish in a dark, deep chocolate brown with copper undertones. Each piece will vary.

# Italian Architectural Forged Steel



## Wrought Iron Railing, Gate & Grille Components

Wrought Iron has been a part of the Architecture & Culture of Europe for over two-thousand years. Here in the United States, there is a reawakening and new appreciation for this beautiful and practical material as both a true building product and Architectural Element. Create works of distinction using our hand crafted wrought iron components.

*In the following pages you will see several terms used to describe some of the pieces.*

**Forged:** Metal that is heated then shaped by hammering.

**Cast:** Creating a shape by pouring molten metal into a mold.

**Edge Hammered:** Hammered on all four edges (Corners).

**Heavily Hammered:** Hammered on all four edges and all four flat sides.

- Materials are shipped Raw/Unfinished
- Proper cleaning and priming will be needed before paint or other coatings are applied.
- Products are hand forged. For this reason dimensions and weights are approximate.
- *Please Note: we do not offer fabrication or design services. Please contact a qualified fabricator.*







## “UNFINISHED” ROUND FORGED BALUSTERS

**WI-500/2**  
Mtl 1/2" Dia.  
**HAMMERED ROUND**  
39-1/2"H  
Wt. 2.5 lbs.

**WI-499/1**  
Mtl 1/2" Dia.  
39-1/2"H  
Wt. 2 lbs.

**WI-499/1L**  
Mtl 1/2" Dia.  
47"H  
Wt. 3 lbs.

1/2"

1-3/8" Dia.

**NEWEL POST**

**WI-497/1**  
Mtl 1/2" Dia.  
35-7/16"H  
Wt. 2.2 lbs.

**WI-497/1L**  
Mtl 1/2" Dia.  
47"H  
Wt. 3 lbs.

**WI-497/2**  
Mtl 1/2" Dia.  
35-7/16"H  
Wt. 2.7 lbs.

**WI-112/11**  
Mtl 1-3/16" Sq.  
47"H  
Wt. 14.3 lbs.



**NEWEL POST**

**WI-109/3**  
Mtl 9/16" Sq.  
35-7/16"H,  
Wt. 4.1 lbs.

**WI-109/3L**  
Mtl 1-3/16" Sq.  
47"H,  
Wt. 3 lbs.

**TAPERED**

**WI-112/5**  
Mtl 1" sq.  
47-1/4"H  
Wt. 12.5 lbs.

**NEWEL POST**  
(Match for WI-98/1)

**Fully Hand-Forged**

1-3/16"

7/8"

1/2"



### SHOES

**WI-SHOE03**  
9/16" hole  
1-9/16" x 1-3/32"

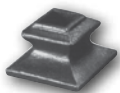

**WI-SHOE819/1**  
**For Newel Post**  
2-3/8" Sq.  
1-3/16" x 1-3/16" hole  
Wt. 1 lb.



**WI-SHOE05**  
9/16" hole  
1-3/16" x 2" (pitch shoe)



All Iron Orders will be charged a Packing Fee - Part # WI-PF10

Phone: 1-800-631-8375 • Fax: 1-800-888-3315





**“UNFINISHED” SQUARE HEAVILY HAMMERED BALUSTERS**

**WI-112/9**  
Mtl 1-3/16" Sq.  
47" H  
Wt. 14.1 lbs.

**NEWEL POST**

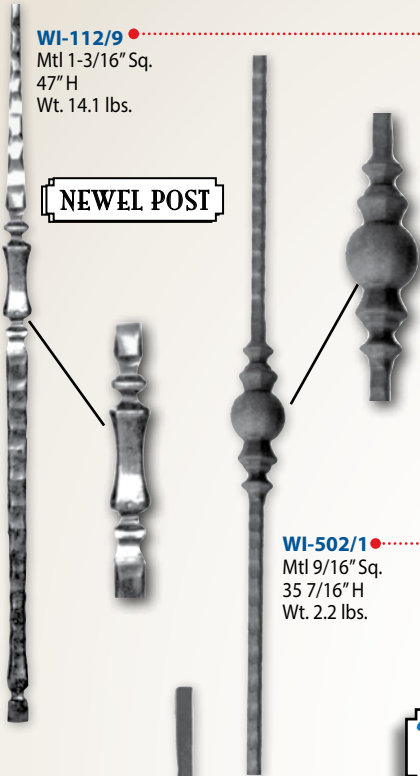

**WI-502/1**  
Mtl 9/16" Sq.  
35 7/16" H  
Wt. 2.2 lbs.



**WI-118/H/1**  
Mtl 1/2" Sq.  
35 7/16" H  
Wt. 3 lbs.

**WI-52/2**  
Mtl 1/2" Sq.  
9-1/4"W  
35-7/16"H  
Wt. 5.5 lbs.

Good match  
WI-118/H/1  
WI-118/H/2



**WI-118/H/2**  
Mtl 1/2" Sq.  
35 7/16" H  
Wt. 3 lbs.

**“UNFINISHED” BALUSTERS**

**WI-70/D/5**  
Mtl 9/16" Sq.  
35-7/16"H  
Depth 8-1/2"  
Wt. 3.4 lbs.

**PLAIN**

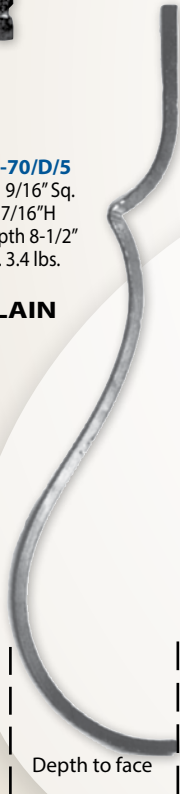

Depth to face



**WI-64/H/10**  
Mtl 9/16" Sq.  
1-3/16"W  
35-7/16"H  
Depth 5"  
Wt. 3.1 lbs.

**WI-44/12**  
Mtl 1-9/16" x  
5/16"  
39-3/8"H  
Depth 9-1/4"  
Wt. 8 lbs.

**HAMMERED**

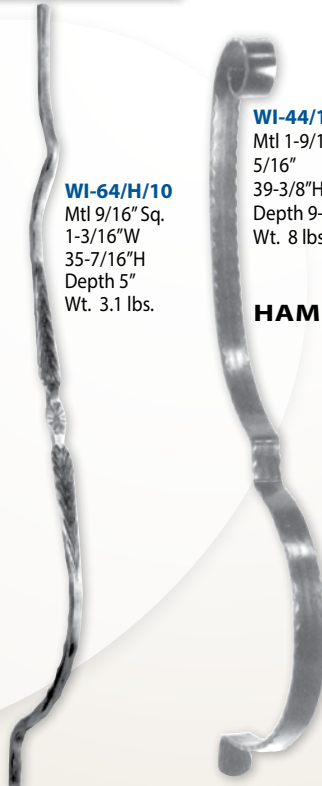

**SHOES**

**WI-SHOE01**  
1/2" hole  
1-9/16" x 1-3/32"

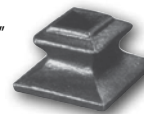

**WI-SHOE02**  
1/2" hole  
1-3/8" x 2" (pitch shoe)



**WI-SHOE03**  
9/16" hole  
1-9/16" x 1-3/32"

**WI-SHOE05**  
9/16" hole  
1-3/16" x 2" (pitch shoe)



**WI-SHOE819/1 For Newel Post**  
2-3/8" Sq.  
1-3/16" x 1-3/16" hole  
Wt. 1 lb.

All Iron Orders will be charged a  
Packing Fee - Part # WI-PF10



**“UNFINISHED” SQUARE HEAVILY HAMMERED BALUSTERS**



**NEWEL POST**

**WI-64/F/1**  
Mtl 1" sq.  
47"H  
Wt. 13 lbs.

(Match for WI-64/F/3, WI-64/F/5, WI-64/G/2)

**WI-64/F/3**  
Mtl 9/16" Sq.  
35-7/16"H  
Wt. 3 lbs.

**WI-64/F/3L**  
Mtl 9/16" Sq.  
47"H  
Wt. 3 lbs.

**WI-64/F/5**  
Mtl 9/16 Sq.  
35-7/16"H  
Wt. 3 lbs.

**WI-64/F/5L**  
Mtl 9/16 Sq.  
47"H  
Wt. 3 lbs.

**WI-64/G/2**  
Mtl 9/16" Sq.  
8-7/8"W  
35-7/16"H  
Wt. 6 lbs.

**“UNFINISHED” ROUND STAMPED BALUSTERS**

**WI-801/5**

Round

**NEWEL POST**

**SHOES**

**For Square Heavily Hammered Balusters**

**WI-SHOE03**  
9/16" hole  
1-9/16" x 1-3/32"

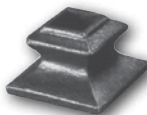

**WI-SHOE05**  
9/16" hole  
1-3/16" x 2" (pitch shoe)



**WI-SHOE1**  
1" hole  
3" Sq.  
Wt. 1 lb.

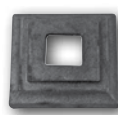

**For Round Stamped Baluster**

**PCSH-302-MP**  
9/16" Round Opening  
Wt. .25 lbs.

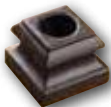

**PCSH-303-MP**  
9/16" Round Opening  
(Pitch Shoe with Set Screw)  
Wt. .30 lbs.



All Iron Orders will be charged a Packing Fee - Part # WI-PF10

Phone:1-800-631-8375 • Fax:1-800-888-3315





**"UNFINISHED" SQUARE HEAVILY HAMMERED BALUSTERS**

**WI-112/10**  
Mtl 1-3/16" Sq.  
47"H  
Wt. 14.3 lbs.

**NEWEL POST**

**WI-108/A/2**  
Mtl 1/2" Sq.  
35-7/16"H  
Wt. 3.5 lbs.

**NEWEL POST**

**WI-112/7**  
Mtl 1" sq.  
47"H  
Wt. 14.5 lbs.  
**FULLY HAND FORGED**



**WI-105/4**  
Mtl 5/8" Sq.  
35-1/2"H  
Wt. 4 lbs.

**WI-108/A/1**  
Mtl. 1/2" Sq.  
35-7/16"H  
Wt. 3.7 lbs.

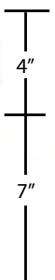

**WI-105/1**  
Mtl 1/2" Sq.  
39-7/16"H  
Wt. 3.3 lbs.

**WI-105/1L**  
Mtl 1/2" Sq.  
47"H  
Wt. 4 lbs.

**WI-105/2**  
Mtl 1/2" Sq.  
39-7/16"H  
Wt. 3 lbs.

**WI-105/2L**  
Mtl 1/2" Sq.  
47"H  
Wt. 4 lbs.

**WI-105/4L**  
Mtl 5/8" Sq.  
47"H  
Wt. 5 lbs.

**SQUARE BAR**  
(4 faces & corners)

**SHOES**

**WI-SHOE01**  
1/2" hole  
1-9/16" x 1-3/32"

**WI-SHOE03**  
9/16" hole  
1-9/16" x 1-3/32"

**WI-SHOE02**  
1/2" hole  
1-3/8" x 2" (pitch shoe)

**WI-SHOE05**  
9/16" hole  
1-3/16" x 2" (pitch shoe)

**WI-SHOE12**  
1/2" hole  
1-1/2" Sq., Wt. 1 lb.

**WI-SHOE58**  
9/16" hole  
1-1/2" Sq., Wt. 1 lb.

**WI-SHOE1**  
1" hole  
3" Sq., Wt. 1 lb.

All Iron Orders will be charged a Packing Fee - Part # WI-PF10





## "UNFINISHED" SQUARE BASKET BALUSTERS

**WI-48/2**  
Mtl 1/2" Sq.  
2-3/16"W  
35-7/16"H  
Wt. 2.4 lbs.

**WI-48/2L**  
Mtl 1/2" Sq.  
2-3/16"W  
47"H  
Wt. 3 lbs.

**PLAIN**

### NEWEL POST

**WI-113/1**  
Mtl 3/4" sq.  
43-5/16"H  
Wt. 8 lbs.

**WI-113/2**  
Mtl 1-3/16" sq.  
43-5/16"H  
Wt. 18 lbs.

**Plain**  
(Match for WI-48/1,  
WI-48/2)



**WI-113/3**  
Mtl 3/4" sq.  
43-5/16"H  
Wt. 8 lbs.

### NEWEL POST

**WI-113/4**  
Mtl 1-3/16" sq.  
43-5/16"H  
Wt. 20 lbs.

**HAMMERED**  
(Match for WI-48/3,  
WI-48/4)

**WI-48/4**  
Mtl 1/2" Sq.  
35-7/16"H  
Wt. 2.4 lbs.

**WI-48/4L**  
Mtl 1/2" Sq.  
47"H  
Wt. 4 lbs.

**HAMMERED**

6-1/4"

**WI-48/1**  
Mtl 1/2" Sq.  
2-3/16"W  
35-7/16"H  
Wt. 2.6 lbs.

**WI-48/1L**  
Mtl 1/2" Sq.  
2-3/16"W  
47"H  
Wt. 3 lbs.

**PLAIN**

12"

**WI-48/3**  
Mtl 1/2" Sq.  
35-7/16"H  
Wt. 2.6 lbs.

**WI-48/3L**  
Mtl 1/2" Sq.  
47"H  
Wt. 4 lbs.

**HAMMERED**

6-1/4"

### SHOES

**WI-SHOE01**  
1/2" hole  
1-9/16" x 1-3/32"

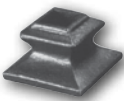

**WI-SHOE02**  
1/2" hole  
1-3/8" x 2"  
(pitch shoe)



**WI-SHOE819/1**  
**For Newel Post**  
2-3/8" Sq.  
1-3/16" x  
1-3/16" hole  
Wt. 1 lb.

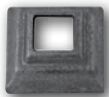

**Single Twist**  
**WI-65-8**  
35-1/2" L  
Wt. 2 lbs.

**1/2" SQUARE  
SOLID PICKETS  
WITH TWIST  
PATTERN**

**Double Twist**  
**WI-53-3**  
35-1/2" L  
Wt. 2 lbs.

**"UNFINISHED" STAIR & RAIL BALUSTERS**



**WI-597/3**  
Mtl 9/16" Sq.  
35 7/16" H  
Wt. 3 lbs.

**WI-597/3L**  
Mtl 9/16" Sq.  
47" H  
Wt. 4 lbs.

**HAMMERED  
EDGES**



**WI-2017/2**  
Mtl 1/2" Sq.  
15-1/8" W  
35-7/16" H  
Ring is 4" I.D.  
5" O.D.  
Wt. 10 lbs.

◆ **ALL HAMMERED BARS** ◆

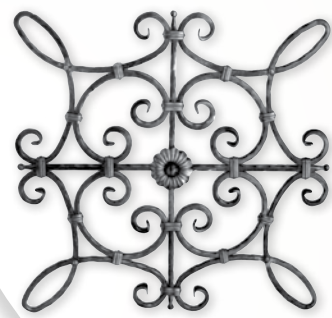

**WI-480/1**  
Mtl 1/2" Sq.  
26" W x 26" H  
Wt. 23 lbs.



**WI-51/3**  
Mtl 1/2" Sq.  
11-13/16" W  
35-7/16" H  
Wt. 9 lbs.

**PLAIN  
BAR**



**"UNFINISHED"  
SQUARE PLAIN  
BAR BALUSTER**

**WI-70/D/1**  
Mtl 9/16" Sq.  
35-7/16" H  
Wt. 3 lbs.

**WI-70/D/1L**  
Mtl 9/16" Sq.  
47" H  
Wt. 3 lbs.

**SHOES**

**WI-SHOE01**  
1/2" hole  
1-9/16" x 1-3/32"

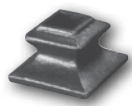

**WI-SHOE03**  
9/16" hole  
1-9/16" x 1-3/32"

**WI-SHOE02**  
1/2" hole  
1-3/8" x 2" (pitch shoe)



**WI-SHOE05**  
9/16" hole  
1-3/16" x 2" (pitch shoe)

All Iron Orders will be charged a Packing Fee - Part # WI-PF10





**"UNFINISHED" STAIR & RAIL BALUSTERS**

◆ **ALL PLAIN BARS** ◆

**WI-1051/1**  
Mtl 1/2" Sq.  
7-5/16"W  
39-1/2"H  
Wt. 4 lbs.

**WI-1051/3**  
Mtl 1/2" Sq.  
5-7/8"W  
39-1/2"H  
Wt. 4 lbs.



**WI-1051/5**  
Mtl 1/2" x 1/4"  
7-1/4"W  
25-5/8"H  
Wt. 3.5 lbs.



*(Small scroll is  
WI-84/7  
see page W-30)*

**FLAT MATERIAL**

**WI-62/1**  
Mtl 3/4"x1/4" Dia.  
9-1/4"W  
28-3/8"H  
Wt. 5.2 lbs.

◆ **ROUND PLAIN BARS** ◆

**WI-540/2**  
Mtl 1/2" Dia.  
9 7/8" W  
28 3/8" H  
Round  
Wt. 5 lbs.



**WI-2009/2**  
Mtl 9/16" Dia.  
13-1/2"W  
35-7/16"H  
Wt. 12 lbs.

**SHOES**

**WI-SHOE01**  
1/2" hole  
1-9/16" x 1-3/32"

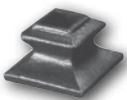

**WI-SHOE02**  
1/2" hole  
1-3/8" x 2"  
(pitch shoe)

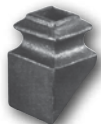

All Iron Orders will be charged a Packing Fee - Part # WI-PF10

Phone: 1-800-631-8375 • Fax: 1-800-888-3315



**"UNFINISHED" SCROLLS**



**WI-1295/1**  
Mtl 1/2" Dia.  
4-3/4"W x  
14-3/16"H  
Wt. 2.1 lbs.



**WI-1309/2**  
Mtl 1/2" Round  
4-5/16"W x  
17-3/4"H  
Wt. 1.9 lbs.

**HAND FORGED**

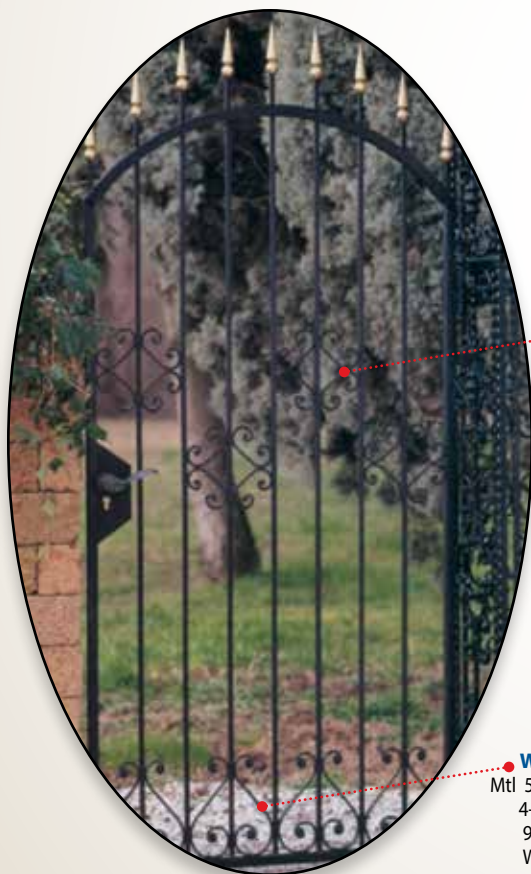

**WI-73/3**  
Mtl 5/16" Sq.  
3-9/16"W  
7-1/16"H  
Wt. 5 lbs.



**WI-84/7**  
Mtl 3/4" x 1/4"  
6"W x  
8-7/8"H  
Wt. 1.6 lbs.



**Component of WI-62/1 on page W-29**

**WI-73/2**  
Mtl 5/16" Sq.  
4-5/16"W  
9-1/16"H  
Wt. 6 lbs.



**WI-92/B/4**  
Mtl 1/2"x1/4"  
6-5/16"W x  
9-7/8"H  
Wt. 1.5 lbs.



All Iron Orders will be charged a Packing Fee - Part # WI-PF10



**"UNFINISHED" SCROLLS**

**WI-80/A/1**

Mtl 1/2"x1/4"  
4-5/16"W  
10-5/8"H  
Wt. .75 lbs.

**HAMMERED END**

Matches WI-80/A/3

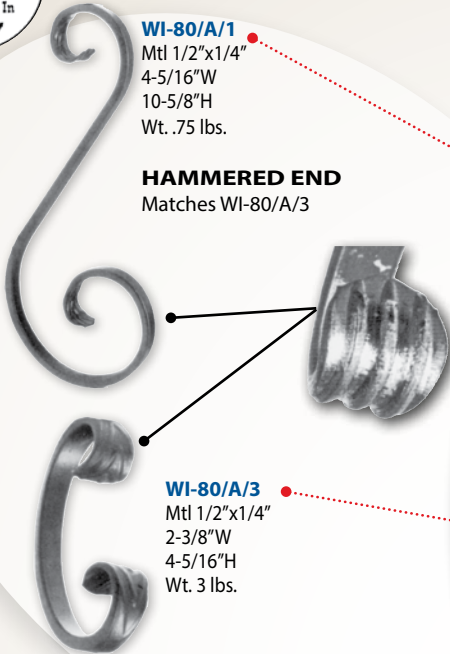

**WI-80/A/3**

Mtl 1/2"x1/4"  
2-3/8"W  
4-5/16"H  
Wt. 3 lbs.



**WI-80/A/9**

Mtl 1/2"x1/4"  
2-3/4"W  
4-1/8"H  
Wt. 4 lbs.



**WI-80/A/12**

Mtl 1/2"x1/4"  
2-3/4"W  
7-1/2"H  
Wt. 5 lbs.



**WI-80/A/10**

Mtl 1/2"x1/4"  
3-3/4"W  
5-1/2"H  
Wt. 5 lbs.



**WI-80/A/11**

Mtl 1/2"x1/4"  
2-9/16"W  
6"H  
Wt. 4 lbs.



All Iron Orders will be charged a Packing Fee - Part # WI-PF10

Phone:1-800-631-8375 • Fax:1-800-888-3315





## "UNFINISHED" SCROLLS

### ROUND MATERIAL



Blow up Of WI-94

**WI-94/C/11**  
Right hand  
Mtl 1/2" Dia.  
13"W x 1  
4-9/16"H  
Wt. 3.5 lbs.



**WI-94/C/12**  
Left hand  
Wt. 3.5 lbs.



**WI-715/1**  
Mtl 1/2" Dia.  
**HAMMERED ROUND**  
22-13/16"W  
34-5/8"H  
Left  
Wt. 14 lbs.



### ROUND MATERIAL

**WI-94/F/5**  
Right hand >  
Mtl 1/2" Dia.  
16-9/16"W  
38-3/16"H  
Wt. 6 lbs.



**WI-94/F/6**  
< Left hand  
Wt. 6 lbs.



**WI-715/2**  
Mtl 1/2" Dia.  
**HAMMERED ROUND**  
22-13/16"W  
34-5/8"H  
Right  
Wt. 14 lbs.



**Flat Material**  
**WI-52/1**  
Mtl 1/2" x 1/4"  
13-3/4"W x  
34-1/4"H  
Wt. 5.5 lbs.



### Plain Bar

(Small scroll is WI-92/B/4  
See page W-30)



**Note for WI-52/1:**  
If necessary, matching "c" scrolls are available and can be easily added to meet local code requirements. (use WI-92/B/4).

**WI-1280/1**  
Mtl 13/16" x 1/4"  
35-7/16"H x 11-13/16"W  
Wt. 7 lbs.



**WI-1279/4**  
Mtl 13/16" x 1/4"  
9-1/4"W x 28-3/8"H  
Wt. 4 lbs.

All Iron Orders will be charged a Packing Fee - Part # WI-PF10





**"UNFINISHED" ROSETTES**

**WI-1010/3**  
Mtl 1/2" Sq.  
11-7/16" Dia.  
Wt. 5 lbs.



**WI-24/2**  
Mtl 3/8" x 3/16"  
15" Dia.  
Wt. 4 lbs.

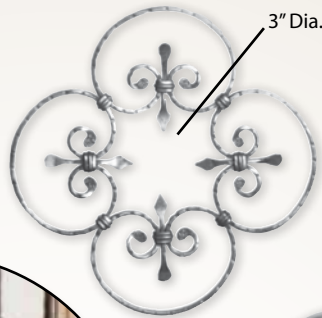

**WI-1010/2**  
Mtl 1/2" Sq.  
17-1/2" Dia.  
Wt. 6.6 lbs.



**HAMMERED BAR**

**WI-26/C/1**  
Mtl 1/2" Sq.  
16-5/8" W  
20-5/8" H  
Wt. 10 lbs.  
floral element on one side only



**UNBREAKABLE  
SNAP-ONS FOR  
1/2" BAR OR TUBE**



**WI-37/3**  
Mtl 1/2"x1/4"  
3-3/4"W  
3-3/4"H  
Wt. 1 lbs.

**WI-35/1**  
Mtl 1/2"x1/4"  
8-1/16"W  
17-1/2"H  
Wt. 3 lbs.

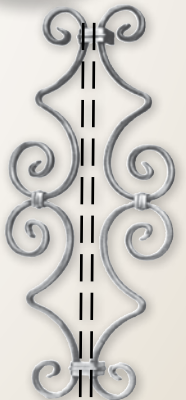

**WI-35/2**  
Mtl 1/2"x1/4"  
7-7/8"W  
13-9/16"H  
Wt. 2 lbs.

**WI-24/3**  
Mtl 1/2"  
23-5/8" Dia.  
Wt. 13 lbs.



All Iron Orders will be charged a Packing Fee - Part # WI-PF10

Phone: 1-800-631-8375 • Fax: 1-800-888-3315



**“UNFINISHED” FINIALS, SPEAR POINTS, SPHERE & FLOWERS**

**FINIALS**

◆ **FORGED** ◆



**WI-113/9**  
3" Dia.

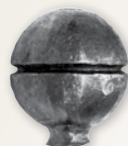

**WI-113/10**  
2-3/4" Dia.



**SPEAR POINT**

◆ **HOT STAMPED** ◆



**WI-727/9**  
Mtl 1-9/16" Sq.  
2-3/4"W x  
4-3/4"H" Sq.



**SPHERE**

◆ **HOT STAMPED** ◆

Smooth, weldable hot-stamped spheres for almost infinite uses.



**WI-116/F/1**  
3/4" Dia.

**WI-116/F/3**  
1-3/16" Dia.

**WI-116/F/2**  
1" Dia.

**WI-116/F/4**  
1-9/16" Dia.

**HAND FORGED FLOWERS**

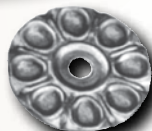

**WI-138/2**  
14 Gauge  
2-3/8" Dia.  
3/16" H,



**WI-94/B/6**  
Mtl 1/8"  
4-15/16" Dia.



**WI-94/B/5**  
Mtl 1/8"  
4-1/8" Dia.



**WI-116/A/3**  
Mtl 1/8" x  
3-3/4" Dia.



Also Shown:  
**WI-94/F/5 &  
WI-94/C/11...**  
*see page W-32*



**WI-94/B/3**  
Mtl 1/8"  
4-1/2"W x  
8-5/8" H

All Iron Orders will be charged a Packing Fee - Part # WI-PF10





## “UNFINISHED” END PIECES FOR HANDRAILS

**WI-114/B/13**  
To be used with  
114/A/3 handrail  
6”H  
Wt. 5 lbs.

**WI-114/B/14**  
To be used with  
114/A/3 handrail  
11-1/2”H  
Wt. 4 lbs.

## “UNFINISHED” RAILINGS

The choice of handrail is as important as the balusters!  
Any of these rails work beautifully with our balusters and scrolls.

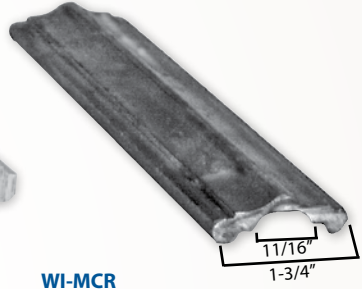
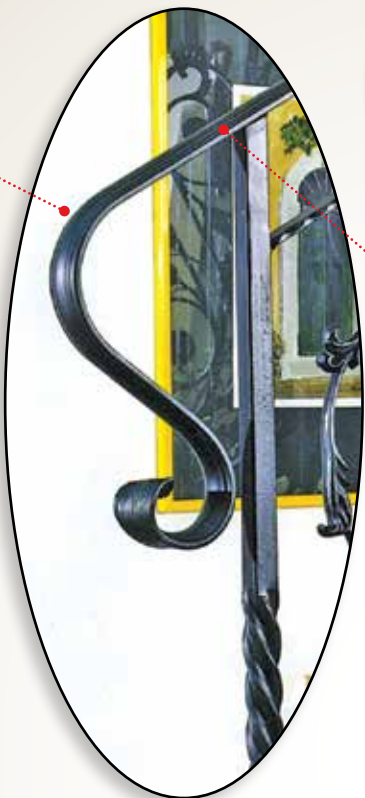

**WI-114/A/3**  
Mtl 1-7/8”x5/8”  
Length 120”  
Wt. 17 lbs.

**WI-MCR**  
Steel handrail to fit 1” channel  
or tubing, Length 20’  
Wt. 26 lbs.

**WI-812/12**  
To be used with  
handrail WI-MCR/112  
11-3/4”H  
Wt. 6 lbs.

**WI-MCR/112**  
Wide steel handrail  
Wide series for 1-1/2” channel,  
flat or tube, Length 20’  
Wt. 42 lbs.

**WI-116/10**  
To be used with  
handrail 114/5  
5-7/8”H  
Wt. 5 lbs.



**WI-114/5**  
Mtl 5/16”  
1-9/16”W  
Length 118-1/8”  
Wt. 17 lbs.

**WI-114/8**  
Mtl 5/16”  
1-9/16”W  
Length of bar 118-1/8”  
Wt. 17 lbs.



All Iron Orders will be charged a Packing Fee - Part # WI-PF10

Phone:1-800-631-8375 • Fax:1-800-888-3315





## “UNFINISHED” BARS & TUBES

### HOT PIERCED BARS



**WI-606/1**  
Mtl 9/16"  
P=5 1/2", 78" H  
14 holes per bar  
Wt. 6 lbs.

**Works With**  
**WI-599/4**



#### ◆ TREE BARK EFFECT ◆

10 FT. LENGTHS

**WI-599/4**  
9/16" Dia.  
Wt. 12 lbs.



### COLD FORGED BARS with HAMMERED EDGES on FOUR SIDES

20 FT. LENGTHS

Custom manufactured in U.S.A.  
All lengths are approximate



Part #	Description	Weight
<b>WI-118-3</b>	5/8" Square	30 lbs.
<b>WI-118-5</b>	3/4" Square	38 lbs.
<b>WI-118-6</b>	1" Square	68 lbs.

### COLD FORGED TUBES with HAMMERED EDGES on FOUR SIDES

20 FT. LENGTHS

For rails, fences and gates.  
All lengths are approximate.

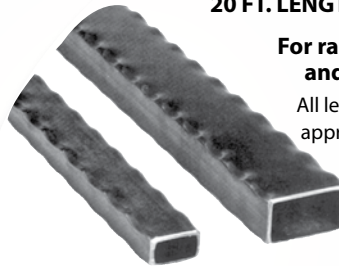

Part #	Description	Weight
<b>WI-118-E-9</b>	1" Square	22 lbs.
<b>WI-118-E-3</b>	1-1/4" Square	31 lbs.

### HAMMERED ROUND BARS

- Custom hammered round bar.
- New automated manufacturing technique that give a hand forged look at an economical price.
- Stock length 118".



Part #	Size	Weight
<b>WI-12-14TB</b>	1/4" Dia.	2 lbs.
<b>WI-12-12TB</b>	1/2" Dia.	7 lbs.
<b>WI-12-38TB</b>	3/8" Dia.	4 lbs.
<b>WI-12-34TB</b>	3/4" Dia.	15 lbs.

### TWISTED BARS

**35-1/2, 40", 42" And 47" Baluster Lengths - 5 Twists**

Part #	Description	Weight
<b>WI-11-12365</b>	1/2" Sq 35-1/2" L	3 lbs.
<b>WI-11-1240</b>	1/2" Sq 40" L	3 lbs.
<b>WI-11-1242</b>	1/2" Sq 42" L	3 lbs.
<b>WI-11-1247</b>	1/2" Sq 47" L	4 lbs.
<b>WI-11-58365</b>	5/8" Sq 35-1/2" L	4 lbs.
<b>WI-11-5840</b>	5/8" Sq 40" L	5 lbs.
<b>WI-11-5842</b>	5/8" Sq 42" L	5 lbs.
<b>WI-11-5847</b>	5/8" Sq 47" L	6 lbs.



All Iron Orders will be charged a Packing Fee - Part # WI-PF10



**WI-001**  
31-1/2" W approx.  
33-15/32" H approx.  
Wt. 48.1 lbs.



**WI-004**  
30-5/16" W approx.  
40-35/64" H approx.  
Wt: 35.3 lbs.



**WI-005**  
55-21/64" W approx.  
26-3/8" H approx.  
Wt: 34 lbs.



**WI-0012**  
24-1/64" W approx.  
36-39/64" H approx.  
Wt: 36.8 lbs.

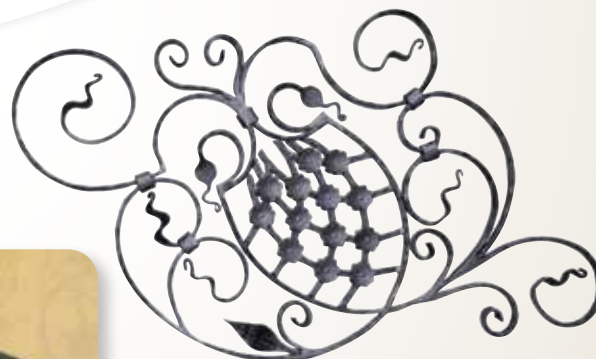

**WI-002**  
31-7/64" W approx.  
30-5/16" H approx.  
Wt. 40.8 lbs.

All Iron Orders will be  
charged a Packing Fee  
- Part # WI-PF10



# Wrought Iron Decorative Panels



**WI-0016** ▶  
10-5/8" W approx.  
39-3/8" H approx.  
Wt: 12.3 lbs.



**WI-0018** ▼  
13" W approx.  
36-7/32" H approx.  
Wt: 17 lbs.

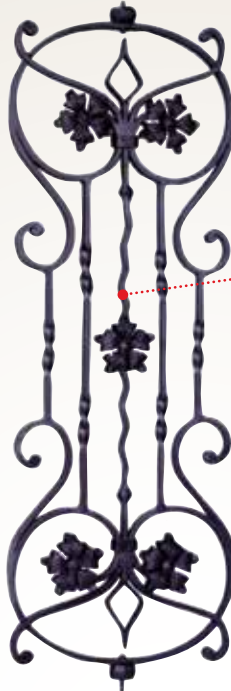

▶ **WI-0017**  
13" W approx.  
37-13/64" H approx.  
Wt: 16.7 lbs.

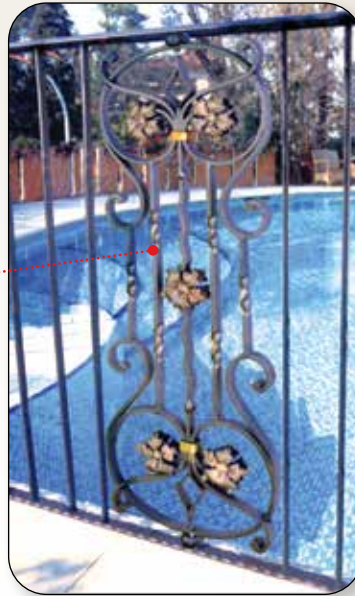

▶ **WI-61/1**  
16-7/8" W approx.  
39-1/2" H approx.  
Wt: 23.8 lbs.



▶ **WI-212/1**  
16-1/2" W approx.  
39-1/2" H approx.  
Wt: 21.6 lbs.

▶ **WI-1281/1**  
51-3/16" W approx.  
17-1/2" H approx.  
Wt: 14.7 lbs.



All Iron Orders will be charged a Packing Fee - Part # WI-PF10



# CABLE·RAIL

## Standard Cable Assemblies Make Measuring, Ordering, and Installing a Breeze

CableRail® Standard Cable Assemblies are sold in a wide range of standardized pre-cut lengths for easy ordering. There is no wasted time taking precise railing measurements; just select assemblies that are longer than you need and trim any excess in the field. Each assembly includes special Threaded Terminal and automatic-locking Quick-Connect®SS attachment fittings that are sleek, simple to use, and easy to conceal. CableRail® is not only extremely durable and aesthetically pleasing but also virtually invisible, allowing for beautiful, unimpaired views.



- Made from high-strength, low maintenance, weather-tough, **316-grade stainless steel**
- Available in 1/8", 3/16" and 1/4" diameter cable to complement any railing design
- Sold in a wide range of standard lengths (5 ft. up to 80 ft. in 5 ft. increments) that can be trimmed to a finished dimension in the field
- Patented automatic-locking Quick-Connect®SS fittings make installation fast and easy
- May be installed on new or existing wood or metal railing frames in exterior, interior, residential and commercial settings
- Product contains recycled material

### Now Available In 3 Cable Diameters: 1/8", 3/16" & 1/4"



#### 1/8" Standard Assemblies

- Our most popular and cost effective cable option
- Perfect for all residential and light commercial projects
- Can be installed on wood or metal frames

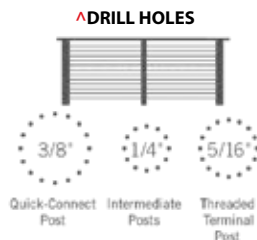

#### 3/16" Standard Assemblies

- Extra durable option for commercial and residential setting
- Can be installed on wood or metal railing frames

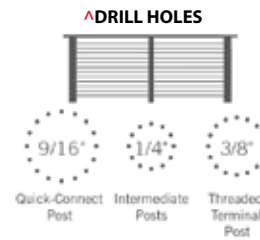

#### 1/4" Standard Assemblies

- Largest, most durable option for high-traffic high wear commercial locations
- Also for railings designs where the "look" of a larger cable is desired
- Recommended for metal railing frames only

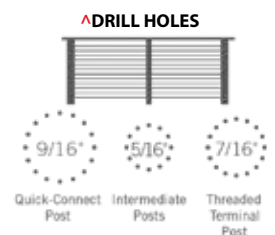

▲ Drill hole sizes may differ if using isolation bushings. Call to confirm correct drill sizes.

Assemblies begin with the threaded terminal...

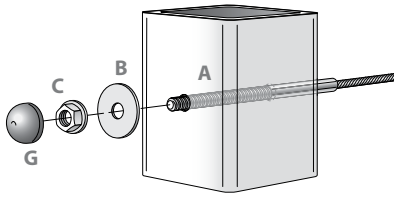

- A = Threaded Terminal Fitting
- B = Flat Washer with Small Hole
- C = Washer Nut
- D = Bare Cable End
- E = Flat Washer with Large Hole
- F = Quick-Connect®SS
- G = End Cap

and end with the QuickConnect®SS

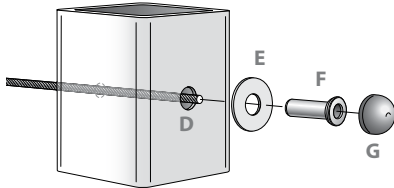

*Note: Accessories vary with wire diameter*



*Stainless Quick-Connect®SS fittings make cable projects quicker and easier than ever*

Each assembly comes with a Threaded Terminal fitting pre-attached to one end and a field installed Quick-Connect®SS fitting for the other end. Simply secure the Threaded Terminal to one end post, lace the free end of the cable through the remaining posts, slip on a Quick-Connect®SS, tension the line, trim the excess, and finish with decorative end caps.



The cable is 1x19 construction 316-grade stainless steel for strength, durability, and weather protection. Available in 1/8", 3/16" and 1/4" diameter.



Our unique patented stainless steel Quick-Connect®SS fitting is attached to the cable in the field **without special tools**. One way jaws allow the cable to easily slide through the fitting in one direction but automatically grab and lock-on when the cable is released. Just slip it on, pull the cable tight and cut the excess.

### Steps for Installing the Standard Cable System

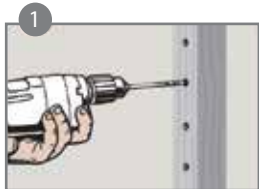

1 Measure, mark and drill holes in all posts



2 Insert Protector sleeves (wood posts) or Grommets/Isolation Bushings (metal posts) at necessary locations

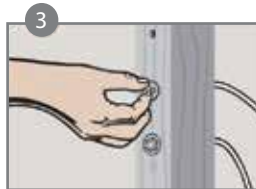

3 Insert the Threaded Terminal into one end termination post and secure with a Snug-Grip® Washer Nut.

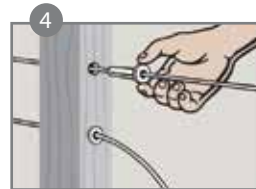

4 Lace the free end of the cable through the remaining posts and slide on a Quick-Connect®SS Fitting



5 Pull the cable through the Quick-Connect®SS fitting to remove the excess slack in the line



6 Tighten the Snug-Grip® Washer Nuts to adjust the final tension in the line



7 Trim the excess threads on the Threaded Terminal and excess cable behind the Quick-Connect®SS.



8 Snap on decorative End Caps over the exposed ends of the Quick-Connect®SS fittings and Snug-Grip® Washer Nuts.



Now Available In 3 Cable Diameters: 1/8", 3/16" & 1/4"



**Cable Assembly Care & Maintenance**

The protective chromium oxide film on the surface of stainless steel gives it superior corrosion resistance. Properly maintained stainless steel provides excellent luster, strength and durability. In most applications stainless steel won't rust or stain even after many years of service, but it's NOT rust or stain proof. When stainless comes in contact with chloride salts, sulfides or other rusting metals, it can discolor or even rust and corrode. With proper care and maintenance, however, stainless steel can remain beautiful and functional for years to come, even when it's exposed to marine environments, polluted surroundings, salted highways or anywhere it might be exposed to corrosive elements.

- Clean stainless with soap and warm water. Never clean with mineral acids or bleaches.
- Never leave stainless in contact with iron, steel or other metals. This can cause rust spots or corrosion.
- Always remove stains or rust spots as soon as possible with either soap and water or a brass, silver, stainless or chrome cleaner.
- Never use coarse abrasives like sandpaper or steel wool on stainless. Use synthetic Scotch pads instead.
- Periodically inspect cable assemblies for proper tension and re-tension as necessary. This is important.
- On outdoor cable installations, coat the inside of the QuickConnect™ SS fittings with Fluid Film® Corrosion Preventative and keep end fittings covered with End Caps. This is especially important in hot and humid areas and coastal locations with salt air.



**Product Guidelines\***

Spacing: For railings, we recommend spacing the cables no more than 3 inches apart and placing posts or vertical members no more than 3 feet apart.

Load: Frames must be built strong enough to support the cable loads of approximately 350 lbs. per cable.

**\* Securely fasten all posts and cap rails. Carefully plan all termination and corner posts for proper clearance, positioning and maximum cable run lengths.**



**Minimum Sizes for All Corner & End Posts**

All other posts should be sized as required for cap rail support strength or for code.



**4 x 6 WOOD**  
3-1/2" wide, 5-1/2" thick



**FLAT BAR**  
2" wide, 1" thick



**ANGLE IRON**  
2" wide, 1/2" thick



**EXTRA STRONG PIPE**  
1-1/2" ID, 1-7/8" OD

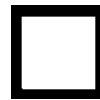

**SQUARE TUBE**  
2" wide, 1/4" wall



**Cables can terminate or run through corner posts**

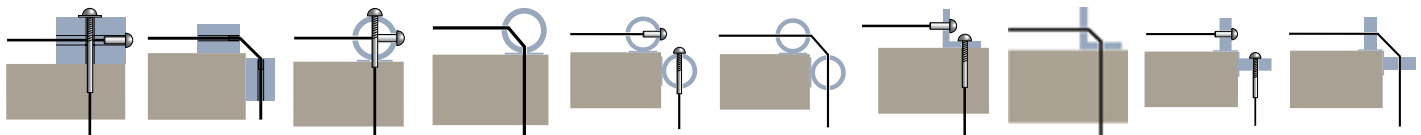

Single & Double Wood Posts\*\*

Single Pipe\*\*

Double Pipe

Angle Iron

Double Flat Bar

**\*\*Offset drill holes at least 1/2" when crossing fittings in a single corner post.**

**NOTE: Since building codes vary by state, county and city, these recommendations may not comply with code requirements in all areas. ALWAYS consult with your local building department before starting your project.**



# CABLE·RAIL

## How To Order:

1. **Carefully Review** all of the installation instructions & guidelines.
2. **Select Assembly Lengths:** Decide where you'll start & end your cables. Straight runs shouldn't be over 80 feet and runs with bends (2 bends at most) NOT over 40 feet. Select assemblies that are at least 1 foot longer than the length of your railing.
3. **Determine Quantities:** The number of assemblies depends on your railing design; remember, space cables no more than 3 inches apart (See guidelines).
4. **Check Accessories:** Count up all the end caps, protector sleeves, rubber grommets and beveled washers.
5. **Place The Order:** Call toll free or fax to the numbers indicated below.

### For Wood Posts



### For Metal Posts



## 1/8" Cable Assemblies:

Each assembly includes:

- 1/8" diameter type 316 Stainless Steel Cable
- One pre-attached threaded terminal fitting (4-1/4" for metal posts or 7-1/2" for wood posts)
- One Stainless Steel QuickConnect<sup>SS</sup> fitting
- Two Stainless Steel flat washers (or two Nylon flat washers for metal posts)
- One Stainless Steel washer nut.
- Stainless Steel Caps or Plastic Caps are sold separately.

With 7-1/2" Terminal (For Wood Posts)	With 4-1/4" Terminal (For Metal Posts)	Cable Rail Assembly
<a href="#">CBLR-305W</a>	<a href="#">CBLR-305M</a>	5 ft.
<a href="#">CBLR-310W</a>	<a href="#">CBLR-310M</a>	10 ft.
<a href="#">CBLR-315W</a>	<a href="#">CBLR-315M</a>	15 ft.
<a href="#">CBLR-320W</a>	<a href="#">CBLR-320M</a>	20 ft.
<a href="#">CBLR-325W</a>	<a href="#">CBLR-325M</a>	25 ft.
<a href="#">CBLR-330W</a>	<a href="#">CBLR-330M</a>	30 ft.
<a href="#">CBLR-335W</a>	<a href="#">CBLR-335M</a>	35 ft.
<a href="#">CBLR-340W</a>	<a href="#">CBLR-340M</a>	40 ft.
<a href="#">CBLR-345W</a>	<a href="#">CBLR-345M</a>	45 ft.
<a href="#">CBLR-350W</a>	<a href="#">CBLR-350M</a>	50 ft.
<a href="#">CBLR-355W</a>	<a href="#">CBLR-355M</a>	55 ft.
<a href="#">CBLR-360W</a>	<a href="#">CBLR-360M</a>	60 ft.
<a href="#">CBLR-365W</a>	<a href="#">CBLR-365M</a>	65 ft.
<a href="#">CBLR-370W</a>	<a href="#">CBLR-370M</a>	70 ft.
<a href="#">CBLR-375W</a>	<a href="#">CBLR-375M</a>	75 ft.
<a href="#">CBLR-380W</a>	<a href="#">CBLR-380M</a>	80 ft.

## 3/16" Cable Assemblies:

Each assembly includes:

- 3/16" diameter type 316 Stainless Steel Cable
- One pre-attached threaded terminal fitting (4-1/4" for metal posts or 7-1/2" for wood posts)
- One Stainless Steel QuickConnect<sup>SS</sup> fitting
- Two Stainless Steel flat washers (or two Nylon flat washers for metal posts)
- One Stainless Steel washer nut
- Stainless Steel Caps or Plastic Caps are sold separately.

With 7-1/2" Terminal (For Wood Posts)	With 4-1/4" Terminal (For Metal Posts)	Cable Rail Assembly
<a href="#">CBLR-305W-316</a>	<a href="#">CBLR-305M-316</a>	5 ft.
<a href="#">CBLR-310W-316</a>	<a href="#">CBLR-310M-316</a>	10 ft.
<a href="#">CBLR-315W-316</a>	<a href="#">CBLR-315M-316</a>	15 ft.
<a href="#">CBLR-320W-316</a>	<a href="#">CBLR-320M-316</a>	20 ft.
<a href="#">CBLR-325W-316</a>	<a href="#">CBLR-325M-316</a>	25 ft.
<a href="#">CBLR-330W-316</a>	<a href="#">CBLR-330M-316</a>	30 ft.
<a href="#">CBLR-335W-316</a>	<a href="#">CBLR-335M-316</a>	35 ft.
<a href="#">CBLR-340W-316</a>	<a href="#">CBLR-340M-316</a>	40 ft.
<a href="#">CBLR-345W-316</a>	<a href="#">CBLR-345M-316</a>	45 ft.
<a href="#">CBLR-350W-316</a>	<a href="#">CBLR-350M-316</a>	50 ft.
<a href="#">CBLR-355W-316</a>	<a href="#">CBLR-355M-316</a>	55 ft.
<a href="#">CBLR-360W-316</a>	<a href="#">CBLR-360M-316</a>	60 ft.
<a href="#">CBLR-365W-316</a>	<a href="#">CBLR-365M-316</a>	65 ft.
<a href="#">CBLR-370W-316</a>	<a href="#">CBLR-370M-316</a>	70 ft.

## 1/4" Cable Assemblies:

Each assembly includes: • 1/4" diameter type 316 Stainless Steel Cable • One pre-attached threaded terminal fitting (4-3/4" long with 2-5/8" thread) use with metal posts  
• One Stainless Steel QuickConnect™SS fitting • Two Nylon flat washers • One Stainless Steel washer nut • Stainless Steel Caps or Plastic Caps are sold separately.

### For Metal Posts



With 4-1/4" Terminal (For Metal Posts)	Cable Rail Assembly
<a href="#">CBLR-305M-14</a>	5 ft.
<a href="#">CBLR-310M-14</a>	10 ft.
<a href="#">CBLR-315M-14</a>	15 ft.
<a href="#">CBLR-320M-14</a>	20 ft.
<a href="#">CBLR-325M-14</a>	25 ft.
<a href="#">CBLR-330M-14</a>	30 ft.
<a href="#">CBLR-335M-14</a>	35 ft.
<a href="#">CBLR-340M-14</a>	40 ft.
<a href="#">CBLR-345M-14</a>	45 ft.
<a href="#">CBLR-350M-14</a>	50 ft.
<a href="#">CBLR-355M-14</a>	55 ft.
<a href="#">CBLR-360M-14</a>	60 ft.
<a href="#">CBLR-365M-14</a>	65 ft.
<a href="#">CBLR-370M-14</a>	70 ft.

## End Caps (sold separately):

### Plastic Caps (2 Required per Assembly)



### Stainless Steel Caps (2 Required per Assembly)



## Accessories for Special Needs:

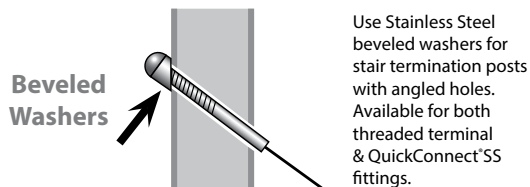

**Beveled Washers**

Use Stainless Steel beveled washers for stair termination posts with angled holes. Available for both threaded terminal & QuickConnect™SS fittings.

### [CBLR-BEVW-QC](#)

Works With **1/8" Cable**  
For QuickConnect™SS™ End  
[CBLR-BEVW-TT](#)  
For Threaded Terminal End

### [CBLR-BEVW-QC-316](#)

Works With **3/16" Cable**  
For QuickConnect™SS™ End  
[CBLR-BEVW-TT-316](#)  
For Threaded Terminal End

### [CBLR-BEVW-QC-14](#)

Works With **1/4" Cable**  
For QuickConnect™SS™ End  
[CBLR-BEVW-TT-14](#)  
For Threaded Terminal End

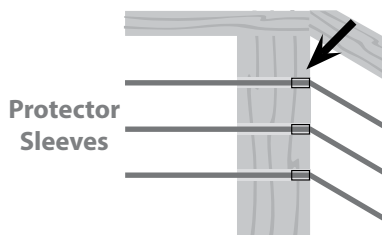

**Protector Sleeves**

Stainless Steel protector sleeves prevent abrasion at angled transitions on wood posts (i.e. stair transition posts or outside faces of double corner posts).

Works With **1/8" & 3/16" Cable**

### [CBLR-PROS](#)

1/4" OD x 1" Long

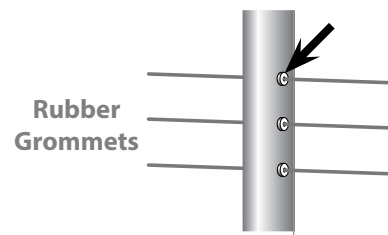

**Rubber Grommets**

Rubber grommets look good on tubular metal posts. Fits 1/4" holes in intermediate posts. (not for corner or end posts).

Works With **1/8" Cable**

### [CBLR-RUBG](#)

7/16" OD Flange - Black

*Post assemblies simplify installation and eliminate welding  
The look of custom, the ease of Prefab!*

**Material: 316 Grade Stainless Steel** (Satin Finish)

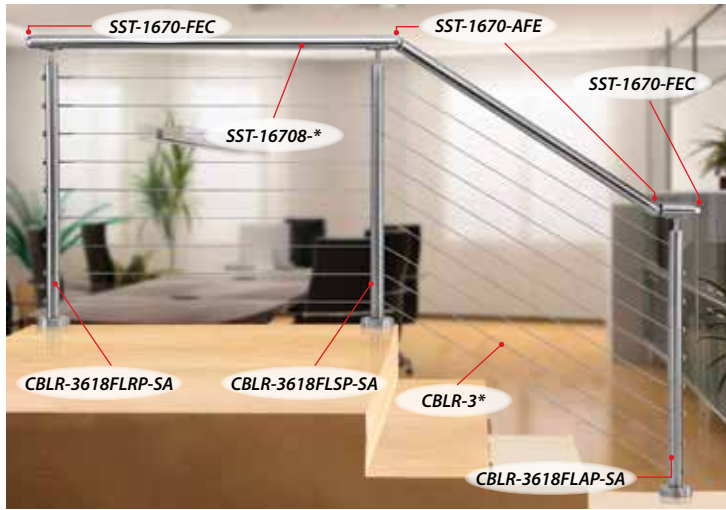

## 1.67" Rail Diameter

Simply-

- Choose your mounting options
- Choose the post positions
- Choose necessary accessories
- Add cable assemblies

*We will produce & ship the goods that meet your requirements*



## Which Pre-fabricated Posts are needed?

### 1) What post height is required?

(specific sizes available, inquire),

**36" Standard or 42" Guardrail Height?**

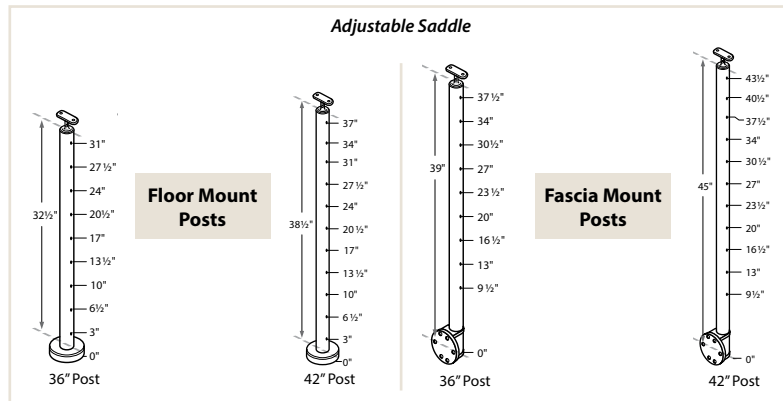
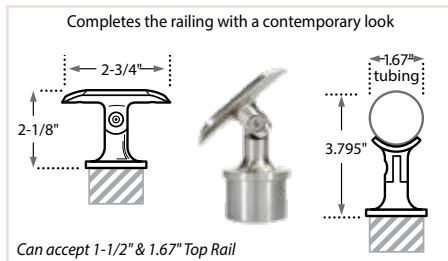

### 2) What type of posts are needed and how many?

#### Standard

**Anchor (required):** This pre-threaded post accepts the threaded terminal of the cable assembly and is the starting point.

**Center (optional):** There should be approximately 3' between each post and therefore the center post should be used as needed.

**Receiver (required):** This pre-threaded accepts the quick connect of the cable assembly and is your end point.

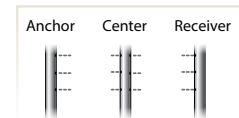

#### Stairs and Slopes

**Stair Anchor Post (optional):** If requires holes on anchor post to be offset. Use part # **OFFSET** (per post type)

**Stair Center Post (required):** Measure rise and tread.

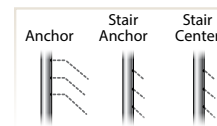
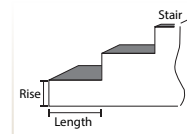

**Custom Stair Post:** If your rise and tread is larger than 7" - 11", then you will need a custom stair post. Costs will vary, please inquire.



**Material: 316 Grade Stainless Steel** *(Satin Finish)*

### 3) Posts are fabricated with Short Adjustable Saddles

Posts include Top Bracket & Screws, now you are ready to pick your Post!

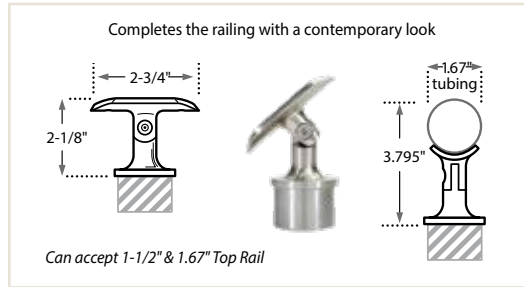

### 4) Which mount option?

#### Floor Mount Post:

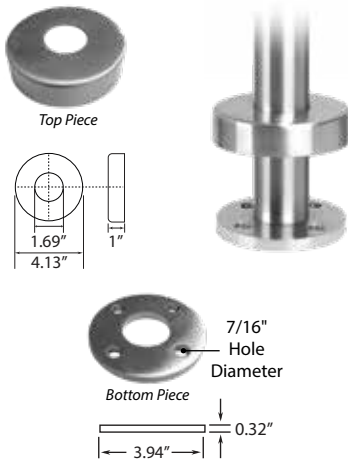

Part #	Post Height	Accepts Cable Diameter	Post Position
<a href="#">CBLR-3618FLAP-SA</a>	36"	1/8"	Anchor Post
<a href="#">CBLR-36316FLAP-SA</a>	36"	3/16"	Anchor Post
<a href="#">CBLR-3618FLCP-SA</a>	36"	1/8"	Center Post
<a href="#">CBLR-36316FLCP-SA</a>	36"	3/16"	Center Post
<a href="#">CBLR-3618FLSP-SA</a>	36"	1/8"	Stair Post
<a href="#">CBLR-36316FLSP-SA</a>	36"	3/16"	Stair Post
<a href="#">CBLR-3618FLRP-SA</a>	36"	1/8"	Receiver Post
<a href="#">CBLR-36316FLRP-SA</a>	36"	3/16"	Receiver Post
<a href="#">CBLR-4218FLAP-SA</a>	42"	1/8"	Anchor Post
<a href="#">CBLR-42316FLAP-SA</a>	42"	3/16"	Anchor Post
<a href="#">CBLR-4218FLCP-SA</a>	42"	1/8"	Center Post
<a href="#">CBLR-42316FLCP-SA</a>	42"	3/16"	Center Post
<a href="#">CBLR-4218FLSP-SA</a>	42"	1/8"	Stair Post
<a href="#">CBLR-42316FLSP-SA</a>	42"	3/16"	Stair Post
<a href="#">CBLR-4218FLRP-SA</a>	42"	1/8"	Receiver Post
<a href="#">CBLR-42316FLRP-SA</a>	42"	3/16"	Receiver Post

#### Fascia Mount Post:

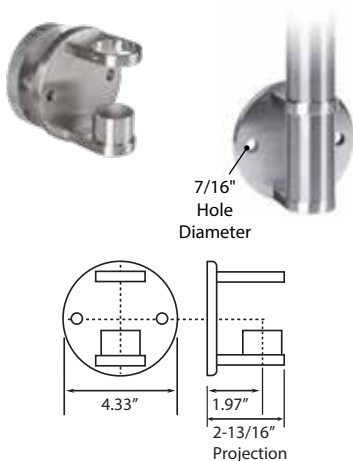

Part #	Post Height	Accepts Cable Diameter	Post Position
<a href="#">CBLR-3618FAAP-SA</a>	36"	1/8"	Anchor Post
<a href="#">CBLR-36316FAAP-SA</a>	36"	3/16"	Anchor Post
<a href="#">CBLR-3618FACP-SA</a>	36"	1/8"	Center Post
<a href="#">CBLR-36316FACP-SA</a>	36"	3/16"	Center Post
<a href="#">CBLR-3618FASP-SA</a>	36"	1/8"	Stair Post
<a href="#">CBLR-36316FASP-SA</a>	36"	3/16"	Stair Post
<a href="#">CBLR-3618FARP-SA</a>	36"	1/8"	Receiver Post
<a href="#">CBLR-36316FARP-SA</a>	36"	3/16"	Receiver Post
<a href="#">CBLR-4218FAAP-SA</a>	42"	1/8"	Anchor Post
<a href="#">CBLR-42316FAAP-SA</a>	42"	3/16"	Anchor Post
<a href="#">CBLR-4218FACP-SA</a>	42"	1/8"	Center Post
<a href="#">CBLR-42316FACP-SA</a>	42"	3/16"	Center Post
<a href="#">CBLR-4218FASP-SA</a>	42"	1/8"	Stair Post
<a href="#">CBLR-42316FASP-SA</a>	42"	3/16"	Stair Post
<a href="#">CBLR-4218FARP-SA</a>	42"	1/8"	Receiver Post
<a href="#">CBLR-42316FARP-SA</a>	42"	3/16"	Receiver Post



## Material: 316 Grade Stainless Steel *(Satin or Polished Finish)*

Required components *(Must be purchased Separately)*

### 5) Choose your cable



**To order cables, see below**  
Our cable rail comes with everything you need for a quick and easy installation, including a threaded stainless steel terminal, Quick-Connect®SS stainless steel tensioning hardware & washers.

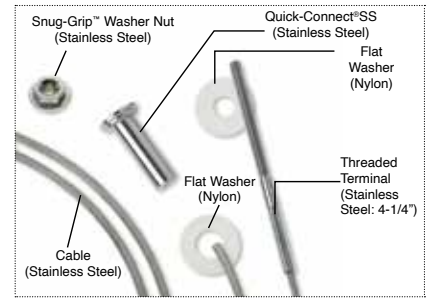

### Cable Rail

- Choose diameter:
  - 1/8" cables are commonly used for residential and light commercial projects
  - 3/16" cables are utilized in commercial jobs or residential applications where a heavier cable is desired
- What cable length do you need?  
If your overall distance between posts is within 1 ft. of the cable assembly, then order the next size up  
*Example:* If the distance is 5 1/2 ft., order a 10 ft. assembly
- Number of assemblies required?  
9 assemblies per 36" post, 11 assemblies per 42" post

### Each assembly includes:

- Choice of diameter type 316 stainless steel cable
- One pre-attached threaded terminal fitting (4-1/4" for metal posts)
- One stainless steel Quick-Connect®SS fitting, two nylon flat washers for metal posts & one stainless steel washer nut

1/8" Dia. Cable	
With 4-1/4" Terminal (for metal posts)	Cable Rail Assembly
<b>CBLR-305M</b>	5 ft.
<b>CBLR-310M</b>	10 ft.
<b>CBLR-315M</b>	15 ft.
<b>CBLR-320M</b>	20 ft.
<b>CBLR-325M</b>	25 ft.
<b>CBLR-330M</b>	30 ft.
<b>CBLR-335M</b>	35 ft.
<b>CBLR-340M</b>	40 ft.
<b>CBLR-345M</b>	45 ft.
<b>CBLR-350M</b>	50 ft.
<b>CBLR-355M</b>	55 ft.
<b>CBLR-360M</b>	60 ft.
<b>CBLR-365M</b>	65 ft.
<b>CBLR-370M</b>	70 ft.
<b>CBLR-375M</b>	75 ft.
<b>CBLR-380M</b>	80 ft.

3/16" Dia. Cable	
With 4-1/4" Terminal (for metal posts)	Cable Rail Assembly
<b>CBLR-305M-316</b>	5 ft.
<b>CBLR-310M-316</b>	10 ft.
<b>CBLR-315M-316</b>	15 ft.
<b>CBLR-320M-316</b>	20 ft.
<b>CBLR-325M-316</b>	25 ft.
<b>CBLR-330M-316</b>	30 ft.
<b>CBLR-335M-316</b>	35 ft.
<b>CBLR-340M-316</b>	40 ft.
<b>CBLR-345M-316</b>	45 ft.
<b>CBLR-350M-316</b>	50 ft.
<b>CBLR-355M-316</b>	55 ft.
<b>CBLR-360M-316</b>	60 ft.
<b>CBLR-365M-316</b>	65 ft.
<b>CBLR-370M-316</b>	70 ft.

### End Caps (Optional)

Plastic Caps  
(2 Required per Assembly)

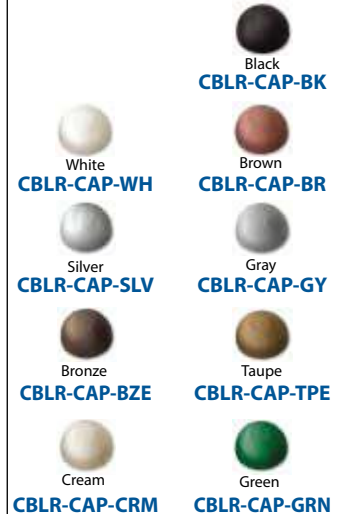

Stainless Steel Caps  
(2 Required per Assembly)

3/4" OD x 3/8" High



### 6) Choose your Top Rail

316 Satin Stainless Steel, 240 Grit Tube, 1.67" O.D. x .08"

Part #	Rail Length
<b>SST-16708-4</b>	4 ft.
<b>SST-16708-8</b>	8 ft.
<b>SST-16708-12</b>	12 ft.
<b>SST-16708-16</b>	16 ft.



Custom Sizes Available

Rails Listed Below Only Works With Adjustable Saddle

Part #	Rail Length	Description
<b>S82-150-CH</b>	12 ft.	304 Polished Stainless Steel, 1.5" O.D. x .050"
<b>SSF1-150-SC-4</b>	4 ft.	304 (180 Grit) Stain Stainless Steel, 1.5" O.D. x .050"
<b>SSF1-150-SC-8</b>	8 ft.	304 (180 Grit) Stain Stainless Steel, 1.5" O.D. x .050"
<b>SWR-150-MP</b>	8 ft.	Solid Maple Dowel (Unfinished), 1.5" O.D. x .050"
<b>SWR-150-OK</b>	8 ft.	Solid Oak Dowel (Unfinished), 1.5" O.D. x .050"

**Material: 316 Grade Stainless Steel** *(Satin or Polished Finish)*

**7) Choose optional accessories to incorporate into your design. Note: These accessories work with 1.67" top rail & flush fittings**

*For 1-1/2" accessories, see pages V-4-10*

Fascia Mount Spacer

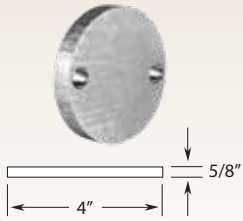

Part #

**SST-1670-FMS**

Round End Cap

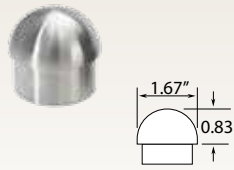

Note: Only used with the saddle brackets

Part #

**SST-1670-EC**

Flat End Cap



Part #

**SST-1670-FEC**

Splicer for 1.67" OD Tubing

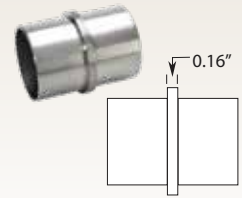

Part #

**SST-1670-SPL**

Radius Wall Return

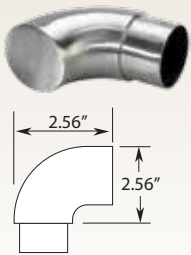

Part #

**SST-1670-RWR**

Flush Radius Elbow

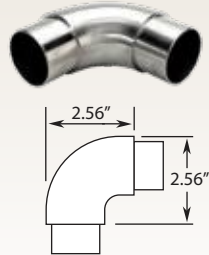

Part #

**SST-1670-FRE**

Adjustable Radius Elbow

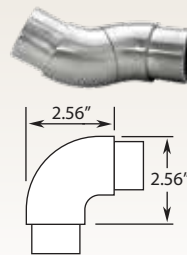

Part #

**SST-1670-ARE**

Flush Elbow

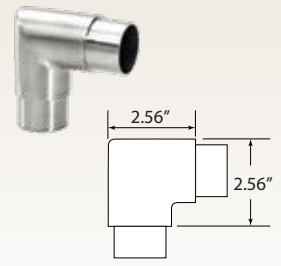

Part #

**SST-1670-FE**

Adjustable Flush Elbow



Part #

**SST-1670-AFE**

Flush Elbow Side Outlet

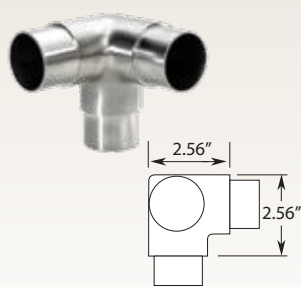

Part #

**SST-1670-FESO**

Flush 135° Elbow

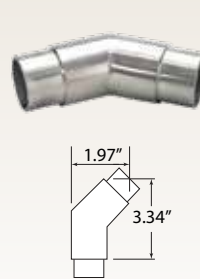

Part #

**SST-1670-F135E**

Wall Flange



Part #

**SST-1670-FL**

Adjustable Angle Flange

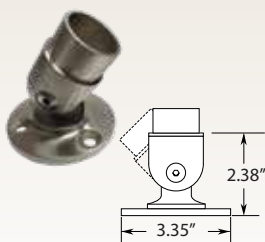

Part #

**SST-1670-AAF**

Flush Cross

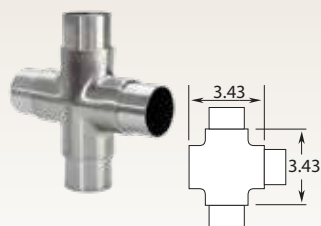

Part #

**SST-1670-FLC**

Hand Rail Bracket



Part #

**SST-1670-HR**





# Kee Lite® Fittings



Kee Lite fittings are made from high grade aluminum silicon magnesium alloy to provide you with a lightweight, corrosion resistant and strong alternative for fabrication of pipe structures.

- Lightweight
- For a stylish, sleek design
- Hidden set screws for smooth aesthetics
- Non-corrosive
- To be used with 1-1/4" pipe size



- HANDRAILS • LIGHTING GRIDS • PLAYGROUNDS • GUARDRAILS
- SET DESIGN & PROPS • WATER TREATMENT FACILITIES
- CORROSIVE ENVIRONMENTS • INDUSTRIAL/COMMERCIAL
- RETAIL & RESTAURANT DESIGN • MUNICIPAL • INSTITUTIONAL



Please note fittings work with schedule 40 pipe only. OD dimensions are much different from standard pipe. Schedule 40 1-1/4" = 1.66" OD

### Hex Key

The only tool needed to build with Kee Lite fittings is a simple hex key.



A/F	Part #	For Pipe Size	A/F
	KK99-7	1-1/4"	5/16"

## Kee Lite® Fittings

(NOTE: Pipe shown in **gold** to accentuate the fitting only. All pipes are available in clear anodized finish only.)

### Single Socket Tee

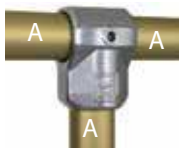

Part #	A Fits Pipe	B	C	D	Weight
KL10-7-125	1-1/4"	2.56"	2.09"	2.52"	.44 lb.

### 90° Elbow

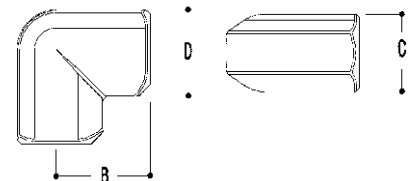
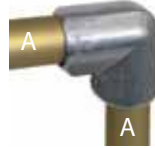

Part #	A Fits Pipe	B	C	D	Weight
KL15-7-125	1-1/4"	2.56"	2.09"	2.32"	.62 lb.

### Classic Urn Stanchion

(See Page D-25)

with Crushed Velour or Braided Rope Guidance



### Retract-It II Stanchions

(See Page D-26)

BELT COLORS:

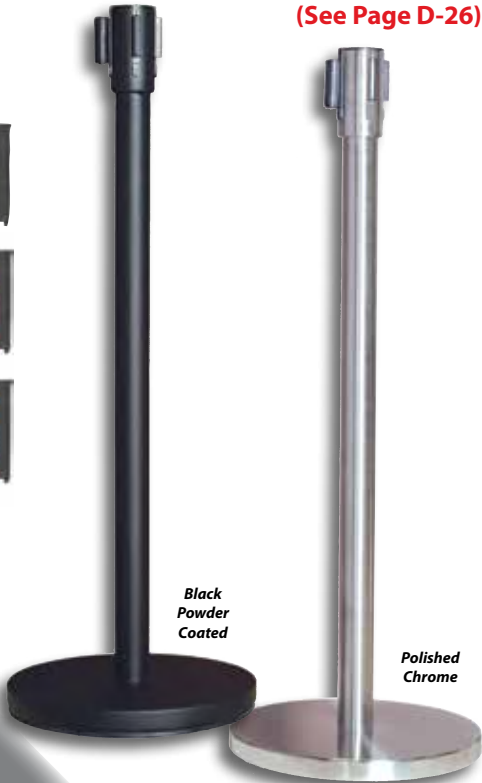

## Stanchions

Outwater offers an extensive range of hard to find Crowd Control and Public Guidance Systems for a wide variety of applications with its broad selection of stocked Stanchions, Stanchion Kits and accessories.

### Plastic Stanchions

(See Pages D-29~30)



Available In: Black, White & Polished Chrome



### Wood Stanchions

(See Pages D-27~28)

