



Family Owned & Operated

OUTWATER INDUSTRIES

EST. 1972

1-800-631-8375 | www.outwater.com

Ultra Bright

Dimmable

Versatile

Slim

"Packs A Bright Punch In A Small Profile"

Introducing...

LED Omni Wand System

A Simple Fixture That Is Multi-Functional



12V



Short Runs



Directional Lighting



Damp Environments



Multiple Levels



Vertical Runs



Long Continuous Runs

Exhibits • Displays • Showcases • Shelving

INDEX



Linear Lighting

See Pages 5-7



Perimeter Lighting:

2-Way 3-Way 4-Way

See Pages 8-9 See Pages 10-11 See Pages 12-13



Omni Vertical

See Pages 14-15



Wall & Stage Perimeter Lighting

See Pages 16-17



Glass Shelf Lighting

See Pages 18-19



Top Mounted Lighting

See Pages 20-21

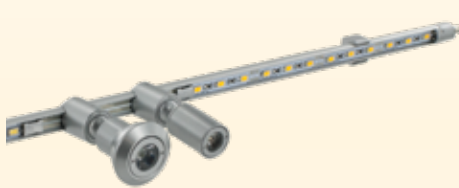

Omni Wand Sample Kit

See Pages 22



Accessories For Omni System

See Pages 23



Quick Reference

See Pages 24-25



How To Measure & Assembly Notes

See Pages 26-27

Omni Wand Sample Kit

**POWER SUPPLY
INCLUDED**



**Only
\$39.95**

See Page 22, For More Information



No Matter What The LED Lighting Project May Be, Omni Wand Offers The Solution

The Problem:

This Display required 16 different custom sized light fixtures, which would have been very costly and time consuming to order with an extensive lead time.



The Solution:

Omni Wand made this project simple and cost effective utilizing just one system. Up to 8 ft. long, the Omni Wand fixture can be easily trimmed to any size required. With Omni Wand, now you are finally in control to create lights as per your specs... not the other way around.

Many Mounting & Connecting Options



One System With Multiple Solutions

1. Standard Pre-Assembled Omni Wand Fixtures

Complete with Lens



Direct Connection

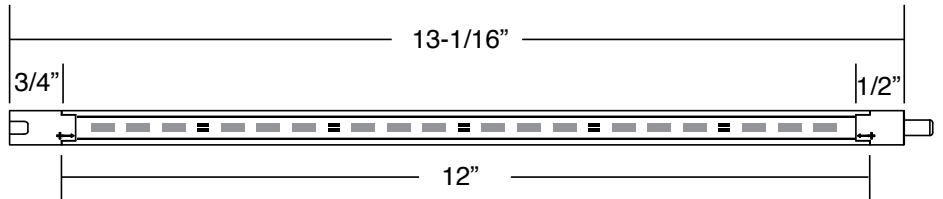
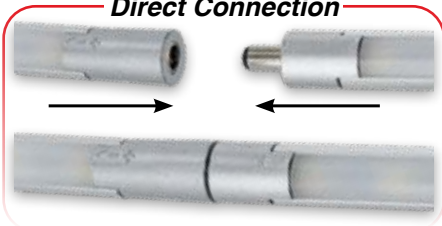

PART #	COLOR TEMP	FINISH	LENGTH	# OF LED CHIPS	TOTAL WATTAGE	MAX # CAN CONNECT	PRICE	
							EACH	10+
LED-OS-116-CW	Cool White	Silver Anodized	12" (Nominal)	18	9W	8	\$15.50	\$13.20 ea.
LED-OS-116-WW	Warm White	Silver Anodized	12" (Nominal)	18	9W	8	\$15.50	\$13.20 ea.

1A & 3A Power Supply (Required)

LED-12V-1A
\$8.95 ea.

2.91"L x 1.61"W x 1.14"H
1A / 12V / 12W
Output Cord: 72"
Color: Black



LED-12V-3A
\$16.15 ea.

3.41"L x 2.31"W x 1.26"H
3A / 12V / 36W
Output Cord: 72"
Color: Black

DC 5.5



Mounting Clips

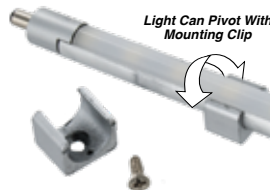

LED-OS-676: \$0.35 ea.

Material: Polycarbonate
Size: 1/2"

Finishing End Cap



LED-OS-667: \$0.50 ea.

Designed to connect directly to housing

Connection & Other Accessories, See Pages 6-7, 23

2. Create Custom LED Linear Lighting Up To 8 Ft.

Slide LED Rigid Ribbon Into Housing



Add More Rigid Ribbon With Clip For Longer Lengths

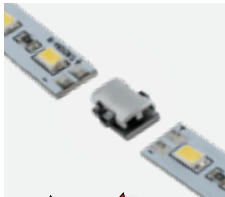

Finish With A Lens



Unique Feature:
Use Rigid Ribbon And Omni Spots With The Same Fixture



Polycarbonate Lens

Power Track For Adjustable Spot Lights

5630 LED Rigid Ribbon Strip
WW- 31000K & CW- 6500K

Trimable Housing



Create Custom LED Linear Lighting

For Cabinets, Bookshelves, Displays, etc.

Up to 8' Long

Special Features:

Omni Wand Can Be Trimmed To An Exact Measurement

Example:

The fixture needed to light a shelf measuring 35-1/16"

Parts Needed To Make Fixture

- 1- Lens (LED-OS-216-4)
- 1- Housing Extrusion (LED-OS-400-4)
- 3- 12" Rigid Ribbon Strips (LED-PCB2-12-*)
- 2- Solderless Clips (LED-PCB-CLIP)
- 1- Female End (LED-OS-665-L)
- 1- Male End (LED-OS-657-R)
- 1- Power Supply (See Page 23)

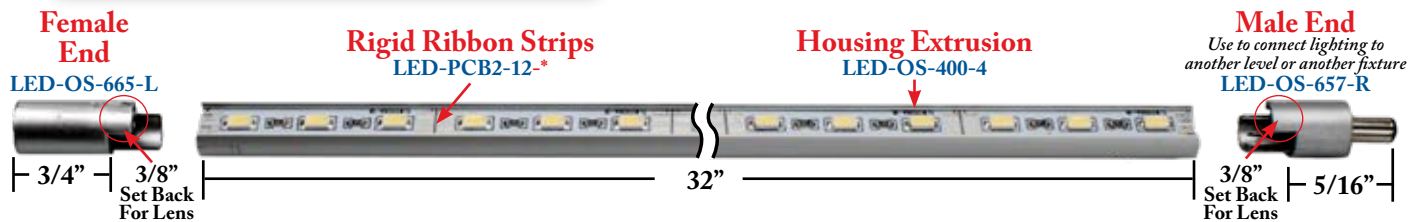

Omni Wand Housing Extrusion: The Housing will need to be cut to 32".

Rigid Ribbons Strips: You will require two 12" Rigid Ribbon Strips and one Rigid Ribbon Strip cut to 8".

You will slide the Rigid Ribbon Strips into the Housing and use the Solderless Clips to join all three Rigid Ribbon Strips together.

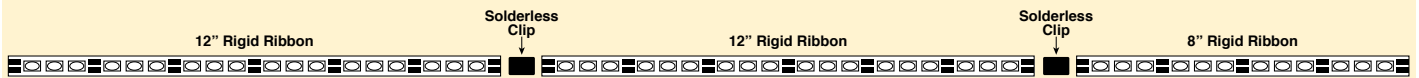

Lens
LED-OS-216-4

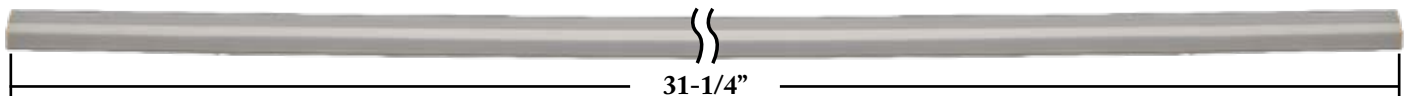

Lens: The Lens will need to be cut to 31-1/4" because the Female and Male Ends require a trim setback of 3/8" for the Male and Female Ends.



Finished Fixture: For this project, we are using a Male End at the end of the fixture in order for us to connect the lights to another level. If you do not want to connect any more fixtures, you can use a Finishing End Cap.

For How To Measure & Assembly Notes, See Pages 26 & 27

Phone: 1-800-631-8375 • Fax: 1-800-888-3315

Due to raw material cost fluctuations, prices are subject to change.

Create Custom LED Linear Lighting

For Cabinets, Bookshelves, Displays, etc.

Up to 8' Long

Housing Extrusion



LED-OS-400-*: \$2.07 per ft.
 4 ft. (*4) & 8 ft. (*8)
 Diameter: 1/2"
 Material: Aluminum
 Finish: Satin Silver Anodized
 Designed to receive our 5630 SMD
 Rigid Ribbon & Power Track

Rigid Ribbon



LED-PCB2-12-*: \$9.95 ea.
 Cool White (*CW) &
 Warm White (*WW)
 Length: 12"
 Trimmable every 2"

Solderless Clips

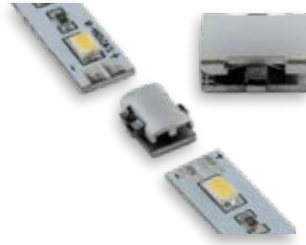

LED-PCB-CLIP: \$1.50 ea.
 Effortlessly joins multiple
 Ribbons and Track

Circuit Bridging Kit



LED-OS-EXT: \$1.99 ea.
 Kit includes 2" Trimmable Power
 Track & 1 Solderless Clip
 Kit allows adjustments to 1/16"
 See Page 27, For More Info

Frosted Lens



LED-OS-216-*: \$.75 per ft.
 4 ft. (*4) & 8 ft. (*8)

Female End



LED-OS-665-*: \$1.55 ea.
 Left (*L) & Right (*R)
 Used for power input

Female End Cap



LED-OS-664: \$.30 ea.

Male End

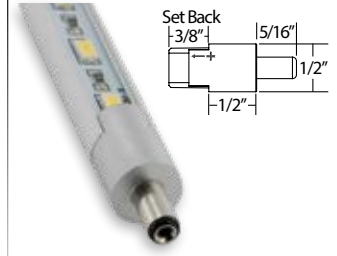

LED-OS-657-*: \$1.55 ea.
 Left (*L) & Right (*R)
 Used for power output

Male End Cap



LED-OS-663: \$.30 ea.

Finishing End Cap

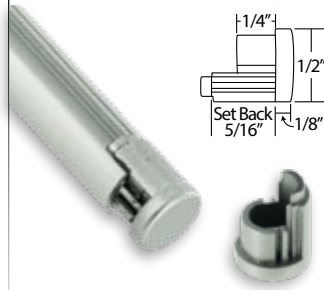

LED-OS-667: \$.50 ea.
 Designed to connect directly to housing

Mounting Clips



LED-OS-676: \$.35 ea.
 Material: Polycarbonate
 Size: 1/2"
 Screw Included

Standoff Mount

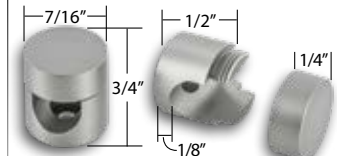

LED-OS-660: \$3.45 ea.
 Material: Aluminum
 Screws Included

Accessories are constructed of nonconductive plastic unless otherwise noted

See Pages 23, For Power Supplies & Accessories

Create Custom LED Linear Lighting

For Cabinets, Bookshelves, Displays, etc.

Up to 8' Long

Female/Female Connecting Cable



LED-OS-223: \$2.95 ea.

Female/Male Connecting Cable



Length- 6-3/4": LED-OS-222: \$2.95 ea.

Length- 24": LED-OS-24: \$3.25 ea.

Length- 30": LED-OS-30: \$3.50 ea.

Length- 48": LED-OS-48: \$3.75 ea.

U-Connector

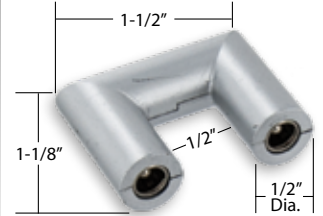

LED-OS-666: \$2.50 ea.

Finishing & Mounting Options

Finishing Options For Single Fixture

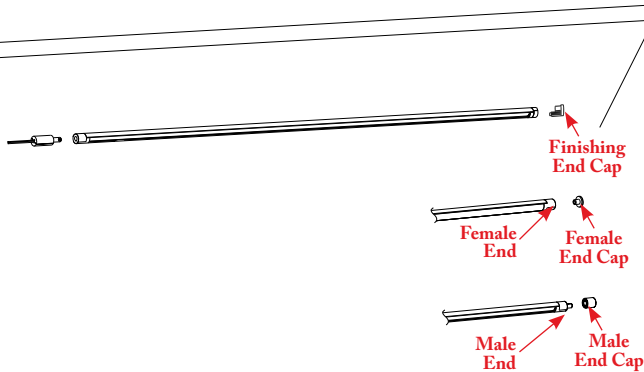

Finishing Option for U-Connector

(For additional illumination)

Multiple U-Connectors can be added as desired

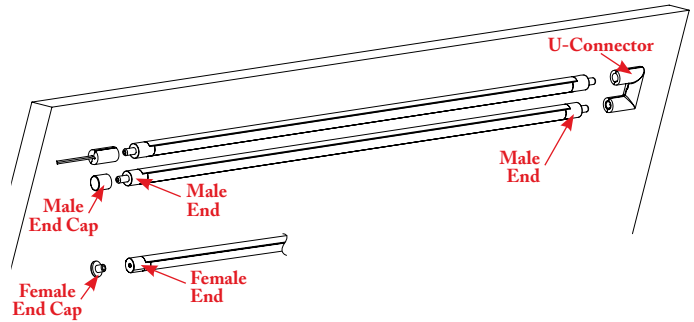

Cabling Option for Shelf to Shelf Connections

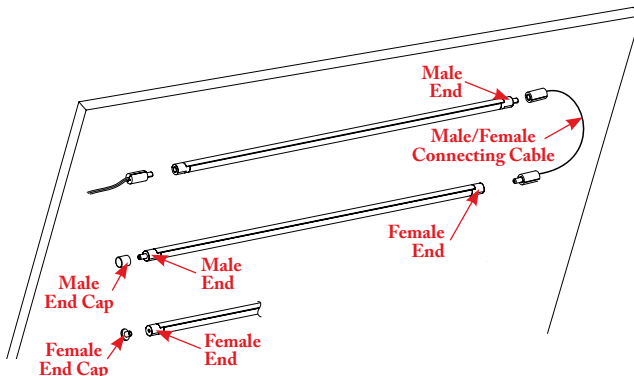

Mounting Options

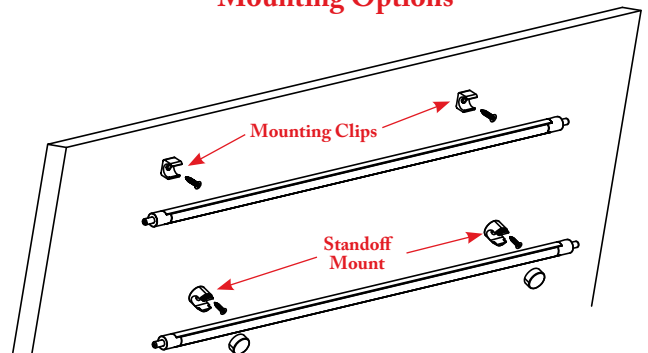

Accessories are constructed of nonconductive plastic unless otherwise noted

See Pages 23, For Power Supplies & Accessories

Phone:1-800-631-8375 • Fax:1-800-888-3315

Due to raw material cost fluctuations, prices are subject to change.

2-Way Perimeter LED Lighting



Highly refined, easy to use, and aesthetically stunning, the LED Omni Wand System features a super slim anodized aluminum housing, which when utilized in conjunction with the system's array of complementary modular component fittings and accessories, enables anyone to easily create and install custom linear LED lighting configurations anywhere desired.

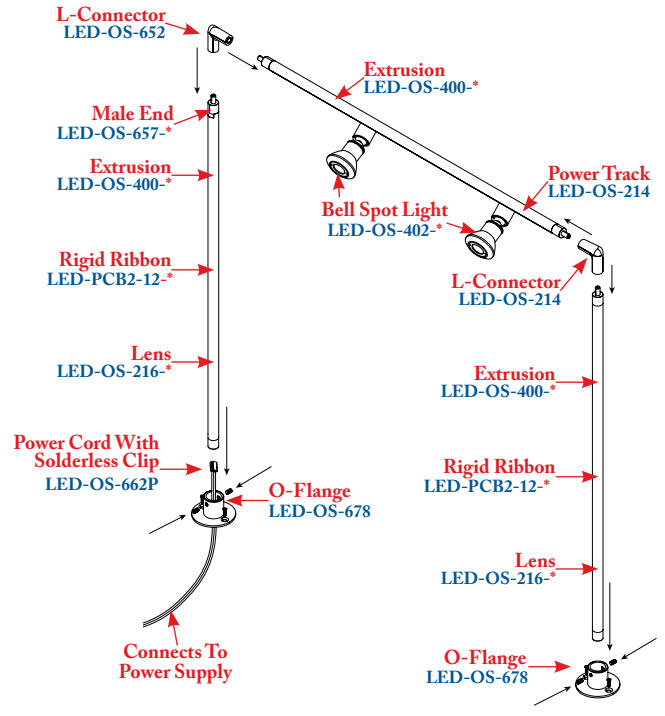
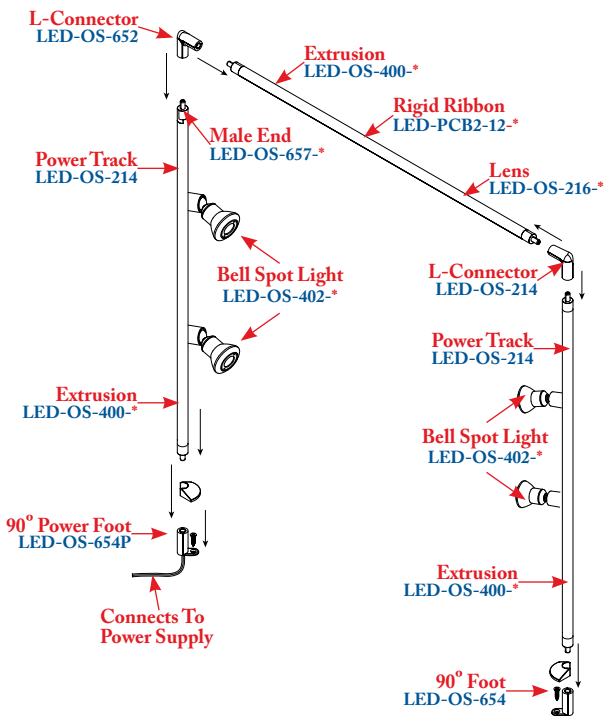

Housing Extrusion



LED-OS-400-*: \$2.07 per ft.
4 ft. (*4) & 8 ft. (*8)

Diameter: 1/2"

Material: Aluminum

Finish: Satin Silver Anodized

Designed to receive our 5630 SMD Rigid Ribbon & Power Track

Rigid Ribbon

In Cool White Or Warm White

12V / 5.4W

Color Temperature:

CW: 6200-6500K /

WW: 2800-3200K

Lumens:

CW: 485 / WW: 450

Beam Spread: 120°



LED-PCB2-12-*: \$9.95 ea.

Cool White (*CW) & Warm White (*WW)

Length: 12"

Trimmable every 2"

Modern Swivel Spot Light

In Cool White Or Warm White

12V / 1W

Lumens:

CW: 80

WW: 60

Beam Spread:

15°

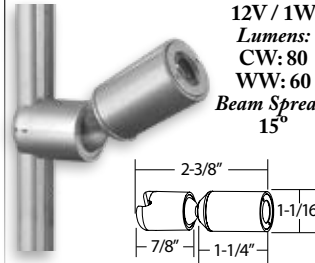

LED-OS-401-*: \$17.30 ea.

Cool White (*CW) & Warm White (*WW)

Bell Swivel Spot Light

In Cool White Or Warm White

12V / 1W

Lumens:

CW: 80

WW: 60

Beam Spread:

15°

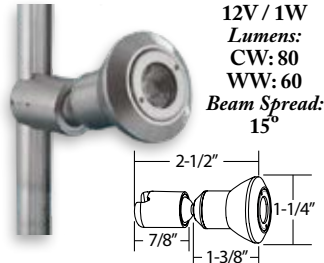

LED-OS-402-*: \$18.70 ea.

Cool White (*CW) & Warm White (*WW)

Accessories are constructed of nonconductive plastic unless otherwise noted

See Pages 23, For Power Supplies & Accessories

2-Way Perimeter LED Lighting



Power Track

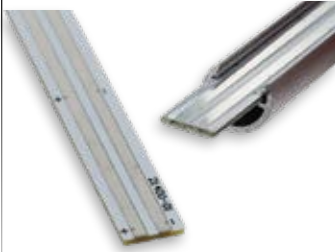

LED-OS-214: \$4.15 ea.
Length: 39"
Works With Any Spot

Solderless Clips



LED-PCB-CLIP: \$1.50 ea.
Effortlessly joins multiple
Ribbons and Track

Circuit Bridging Kit



LED-OS-EXT: \$1.99 ea.
Kit includes 2" Trimmable Power
Track & 1 Solderless Clip
Kit allows adjustments to 1/16"
See Page 27, For More Info

Frosted Lens



LED-OS-216-*: \$0.75 per ft.
4 ft. (*4) & 8 ft. (*8)

Male End

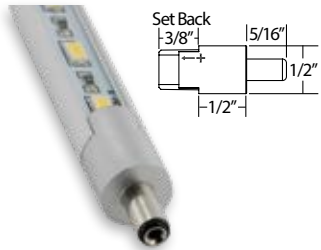

LED-OS-657-*: \$1.55 ea.
Left ("L") & Right ("R")
Used for power output

L-Connector

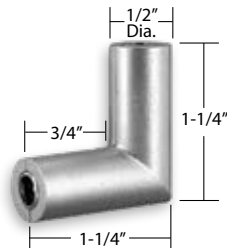

LED-OS-652: \$2.50 ea.

90° Foot (Plastic)

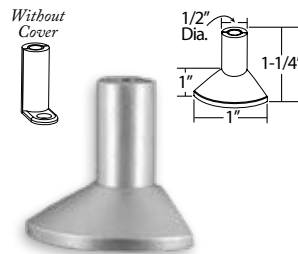

LED-OS-654: \$2.35 ea.
For heights over 2 ft. with multiple
spots we recommend metal O-Flange
Cover & Screw Included

90° Power Foot (Plastic)



LED-OS-654P: \$3.30 ea.
With 60" power cord
For heights over 2 ft. with multiple
spots we recommend metal O-Flange
Cover & Screw Included

Deluxe O-Flange (Metal)

Offers robust screw mounted support and is ideal for use in highly trafficked
vertical or horizontal applications. Can be used on top & bottom.



LED-OS-681: \$7.95 ea.
2 Screws Included

Power Cord With Solderless Clip

Designed to provide power to Rigid Ribbon Strips housed in the O-Flange.
Comes with Female DC 5.5 and one Solderless Clip.
O-Flange sold separately.



Works With O-Flange

LED-OS-662P: \$2.30 ea.
Length: 60"

Base / Foot Styles



Accessories are constructed of nonconductive plastic unless otherwise noted
See Pages 23, For Power Supplies & Accessories

3-Way Perimeter LED Lighting

Similar in illumination to much higher wattage bulbs of comparable media, the LED Omni Wand System produces high lumen output and color rendering indexes to ensure that your exhibits, displays, showcases and shelving always look their very best. Offered in both cool white and warm white, the system is ultra energy efficient, yet consumes only a few watts, with an approximate 50,000 hour bulb life.

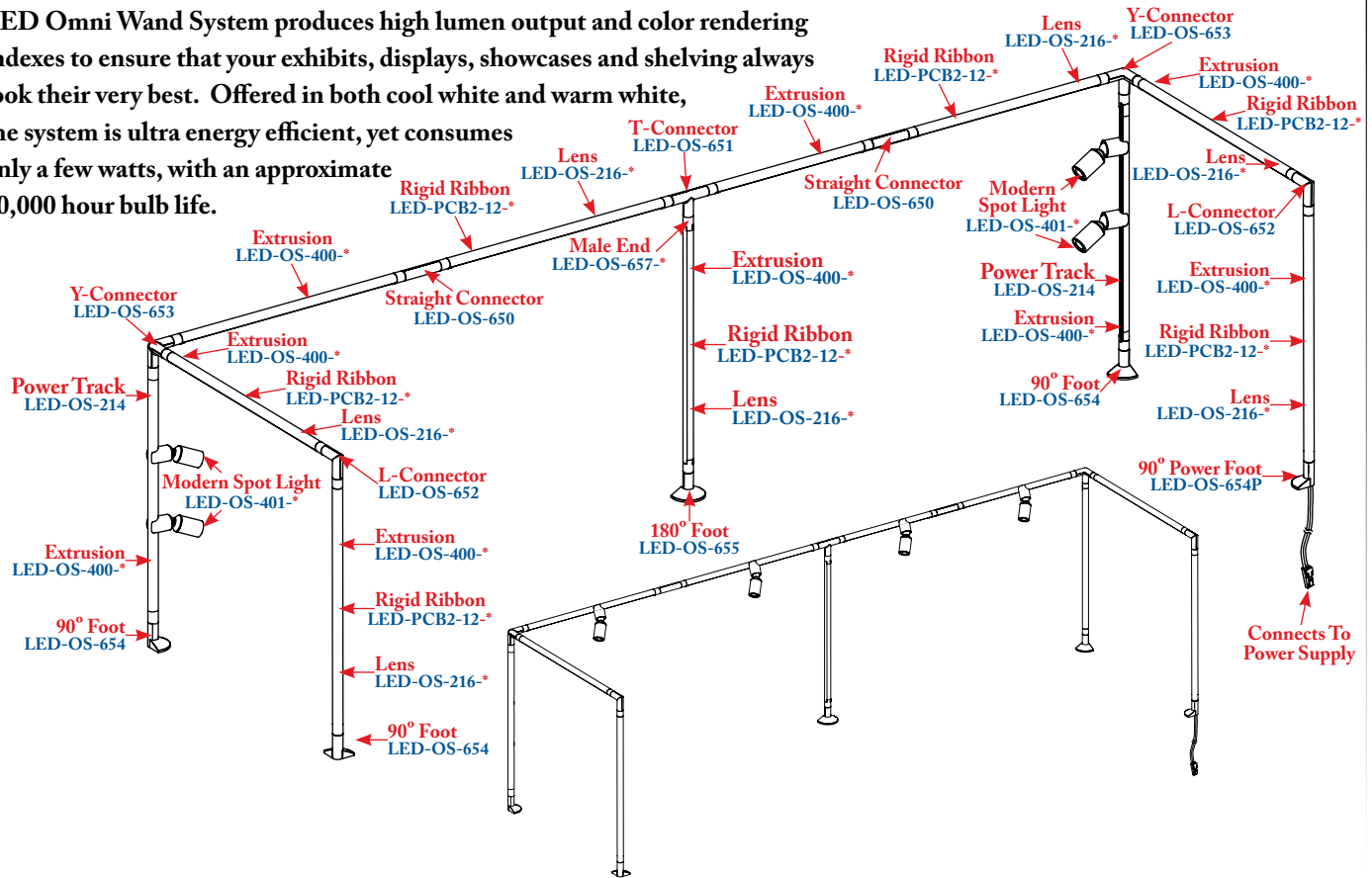

Housing Extrusion



LED-OS-400*: \$2.07 per ft.
 4 ft. (*4) & 8 ft. (*8)
 Diameter: 1/2"
 Material: Aluminum
 Finish: Satin Silver Anodized
 Designed to receive our 5630 SMD Rigid Ribbon & Power Track

Rigid Ribbon



LED-PCB2-12-*: \$9.95 ea.
 Cool White (*CW) & Warm White (*WW)
 Length: 12"
 Trimmable every 2"

Modern Swivel Spot Light

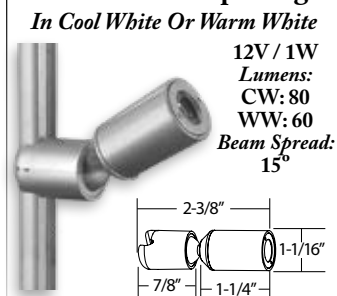

LED-OS-401*: \$17.30 ea.
 Cool White (*CW) & Warm White (*WW)
 12V / 1W
 Lumens: CW: 80, WW: 60
 Beam Spread: 15°

Bell Swivel Spot Light



LED-OS-402*: \$18.70 ea.
 Cool White (*CW) & Warm White (*WW)
 12V / 1W
 Lumens: CW: 80, WW: 60
 Beam Spread: 15°

Accessories are constructed of nonconductive plastic unless otherwise noted
See Pages 23, For Power Supplies & Accessories

3-Way Perimeter LED Lighting



Power Track

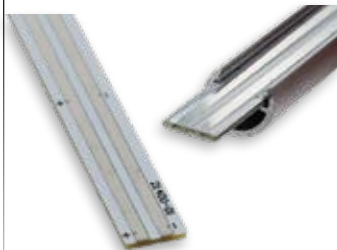

LED-OS-214: \$4.15 ea.
Length: 39"
Works With Any Spot

Solderless Clips



LED-PCB-CLIP: \$1.50 ea.
Effortlessly joins multiple
Ribbons and Track

Circuit Bridging Kit



LED-OS-EXT: \$1.99 ea.
Kit includes 2" Trimmable Power
Track & 1 Solderless Clip
Kit allows adjustments to 1/16"
See Page 27, For More Info

Frosted Lens



LED-OS-216-*: \$0.75 per ft.
4 ft. (*4) & 8 ft. (*8)

Male End

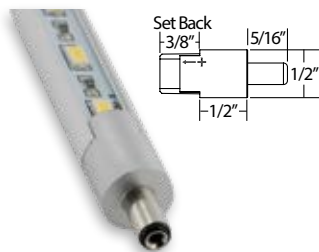

LED-OS-657-*: \$1.55 ea.
Left (L) & Right (R)
Used for power output

L-Connector

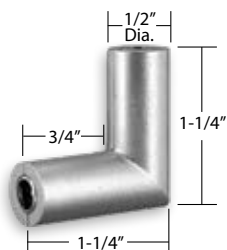

LED-OS-652: \$2.50 ea.

Y-Connector



LED-OS-653: \$3.30 ea.

T-Connector

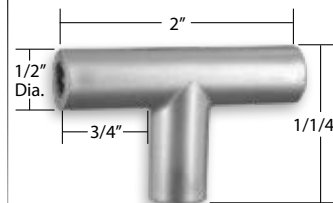

LED-OS-651: \$3.45 ea.

Straight Connector



LED-OS-650: \$2.50 ea.

90° Foot (Plastic)

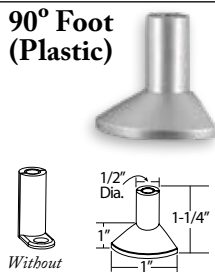

LED-OS-654: \$2.35 ea.

For heights over 2 ft. with
multiple spots we
recommend metal O-Flange
Cover & Screw Included

90° Power Foot (Plastic)



LED-OS-654P: \$3.30 ea.

With 60" power cord
For heights over 2 ft. with
multiple spots we
recommend metal O-Flange
Cover & Screw Included

180° Foot (Plastic)



LED-OS-655: \$2.35 ea.

For heights over 2 ft. with
multiple spots we
recommend metal O-Flange
Cover & Screw Included

180° Power Foot (Plastic)



LED-OS-655P: \$3.30 ea.

With 60" power cord
For heights over 2 ft. with
multiple spots we
recommend metal O-Flange
Cover & Screw Included

Accessories are constructed of nonconductive plastic unless otherwise noted

See Pages 23, For Power Supplies & Accessories

Phone: 1-800-631-8375 • Fax: 1-800-888-3315

Due to raw material cost fluctuations, prices are subject to change.

4-Way Perimeter LED Lighting

The LED Omni Wand System's Housing can be easily rotated even after installation to direct a generous 120° linear beam spread wherever it may be desired. In addition, the System can be concurrently utilized with corresponding snap on Modern Swivel or Bell Swivel Spot Lights for a targeted 15° beam spread, which can be added, removed or even repositioned to accommodate one's ever changing lighting needs.

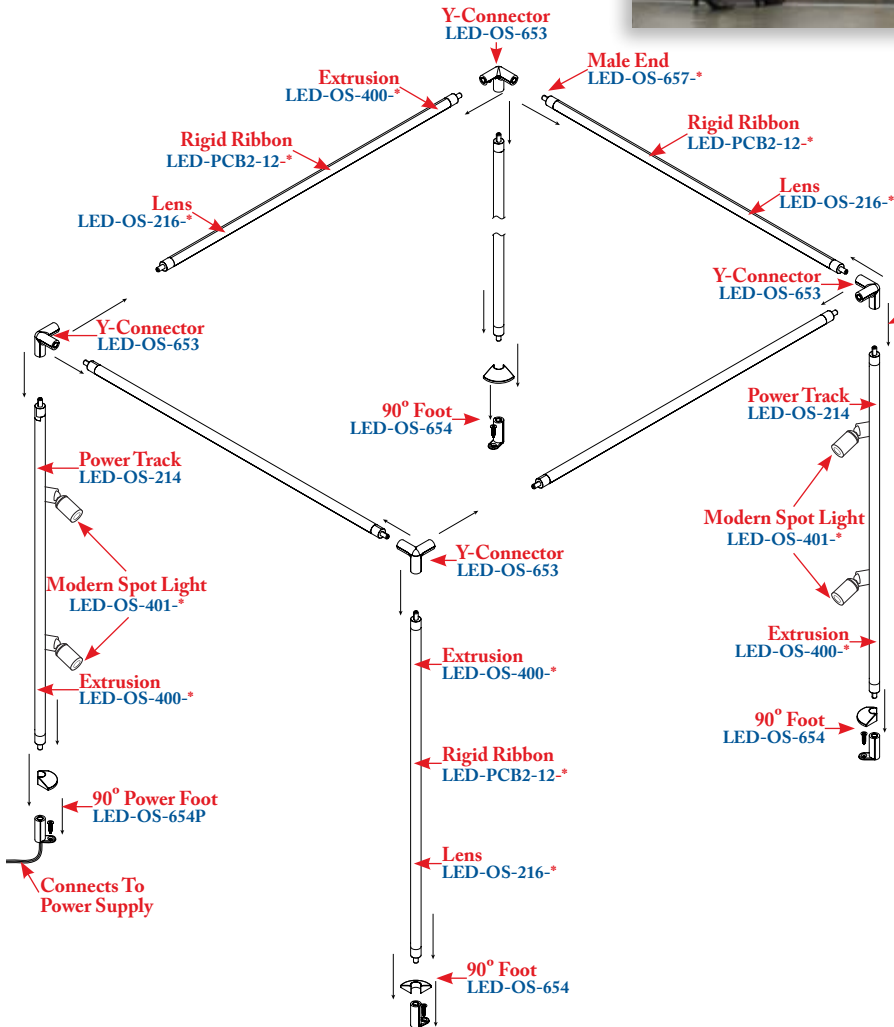

Accessories are constructed of nonconductive plastic unless otherwise noted
 See Pages 23, For Power Supplies & Accessories

4-Way Perimeter LED Lighting



Housing Extrusion



LED-OS-400-*: \$2.07 per ft.
*4 ft. (*4) & 8 ft. (*8)*
 Diameter: 1/2"
 Material: Aluminum
 Finish: Satin Silver Anodized
 Designed to receive our 5630 SMD
 Rigid Ribbon & Power Track

Rigid Ribbon



In Cool White Or Warm White
 12V / 5.4W
 Color Temperature:
 CW: 6200-6500K /
 WW: 2800-3200K
 Lumens:
 CW: 485 / WW: 450
 Beam Spread: 120°

LED-PCB2-12-*: \$9.95 ea.
*Cool White (*CW) &
 Warm White (*WW)*
 Length: 12"
 Trimmable every 2"

Modern Swivel Spot Light

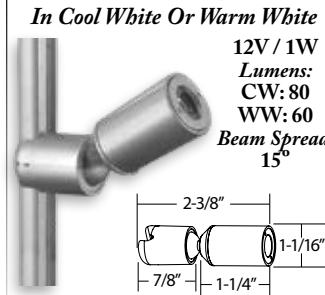

In Cool White Or Warm White
 12V / 1W
 Lumens:
 CW: 80
 WW: 60
 Beam Spread:
 15°

LED-OS-401-*: \$17.30 ea.
*Cool White (*CW) &
 Warm White (*WW)*

Bell Swivel Spot Light



In Cool White Or Warm White
 12V / 1W
 Lumens:
 CW: 80
 WW: 60
 Beam Spread:
 15°

LED-OS-402-*: \$18.70 ea.
*Cool White (*CW) &
 Warm White (*WW)*

Power Track



LED-OS-214: \$4.15 ea.
 Length: 39"
 Works With Any Spot

Solderless Clips



LED-PCB-CLIP: \$1.50 ea.
 Effortlessly joins multiple
 Ribbons and Track

Circuit Bridging Kit



LED-OS-EXT: \$1.99 ea.
 Kit includes 2" Trimmable Power
 Track & 1 Solderless Clip
 Kit allows adjustments to 1/16"
 See Page 27, For More Info

Frosted Lens



LED-OS-216-*: \$0.75 per ft.
*4 ft. (*4) & 8 ft. (*8)*

Male End

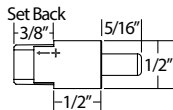
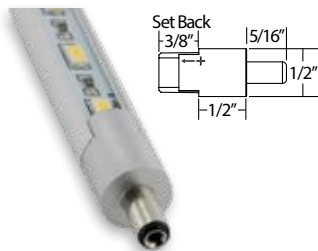

LED-OS-657-*: \$1.55 ea.
*Left (*L) & Right (*R)*
 Used for power output

Y-Connector

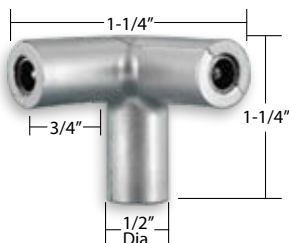
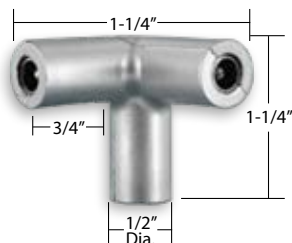

LED-OS-653: \$3.30 ea.

90° Foot (Plastic)

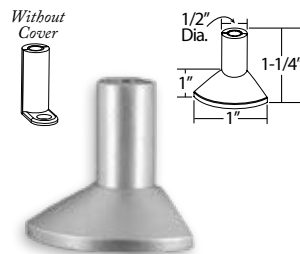
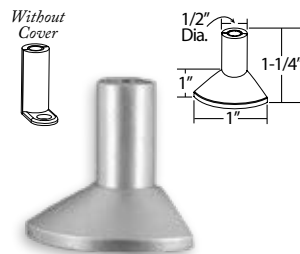

LED-OS-654: \$2.35 ea.
 For heights over 2 ft. with multiple
 spots we recommend metal O-Flange
 Cover & Screw Included

90° Power Foot (Plastic)



LED-OS-654P: \$3.30 ea.
 With 60" power cord
 For heights over 2 ft. with multiple
 spots we recommend metal O-Flange
 Cover & Screw Included

Accessories are constructed of nonconductive plastic unless otherwise noted

See Pages 23, For Power Supplies & Accessories

Phone: 1-800-631-8375 • Fax: 1-800-888-3315

Due to raw material cost fluctuations, prices are subject to change.

LED Omni Vertical

Available In: Pre-Fabricated 10" & 16" Lengths
Or Create Your Own Length

As previously noted, the LED Omni Wand System's Spot Vertical LED Lighting System enables one to utilize corresponding snap on Modern Swivel or Bell Swivel Spot Lights for a targeted 15° beam spread, which can be added, removed or even repositioned to accommodate one's ever changing lighting needs along the length of the System's kitted 10-in. and 16-in. long, ½-in. diameter silver anodized aluminum fixtures.

Omni Wand Fixture

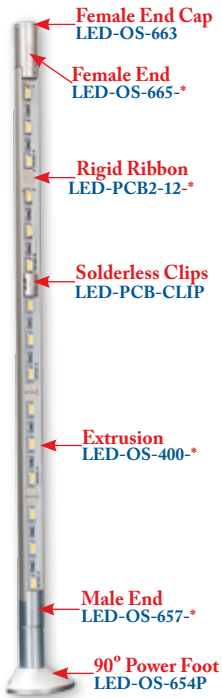

Modern Style Fixture

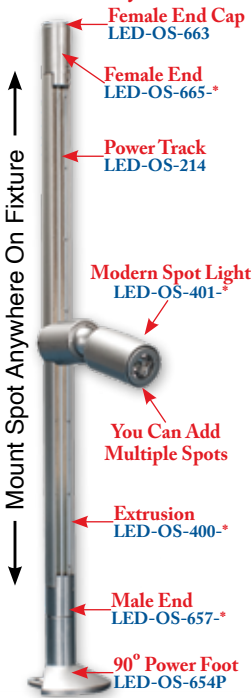

Bell Style Fixture



Base / Foot Styles

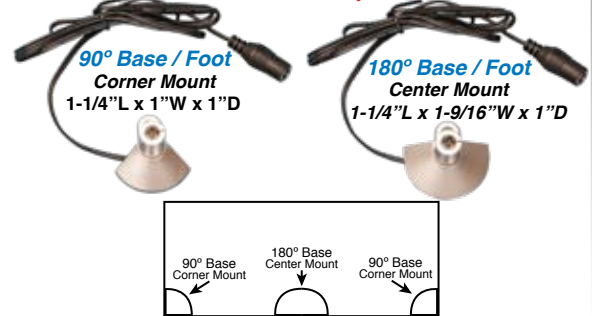

Pricing For 10" & 16" Pre-Fabricated Fixtures

PART #	COLOR TEMP	KIT INCLUDES	SIZE	# OF LED CHIPS	TOTAL WATTAGE	PRICE
OMNI WAND FIXTURE						
LED-OS-V10-3*180	Cool White (*CW)	(1) Wand Light & (1) 180° Base / Foot	10" Height	15	7.5W	\$14.20 ea.
LED-OS-V16-3*180		(1) Wand Light & (1) 180° Base / Foot	16" Height	24	12W	\$19.25 ea.
LED-OS-V10-3*90	Warm White (*WW)	(1) Wand Light & (1) 90° Base / Foot	10" Height	15	7.5W	\$14.20 ea.
LED-OS-V16-3*90		(1) Wand Light & (1) 90° Base / Foot	16" Height	24	12W	\$19.25 ea.
MODERN STYLE FIXTURE						
LED-OS-V10-1*180	Cool White (*CW)	(1) Modern Spot Light & (1) 180° Base / Foot	10" Height	1	1W	\$25.60 ea.
LED-OS-V16-1*180		(1) Modern Spot Light & (1) 180° Base / Foot	16" Height	1	1W	\$26.55 ea.
LED-OS-V10-1*90	Warm White (*WW)	(1) Modern Spot Light & (1) 90° Base / Foot	10" Height	1	1W	\$25.60 ea.
LED-OS-V16-1*90		(1) Modern Spot Light & (1) 90° Base / Foot	16" Height	1	1W	\$26.55 ea.
BELL STYLE FIXTURE						
LED-OS-V10-2*180	Cool White (*CW)	(1) Bell Spot Light & (1) 180° Base / Foot	10" Height	1	1W	\$26.95 ea.
LED-OS-V16-2*180		(1) Bell Spot Light & (1) 180° Base / Foot	16" Height	1	1W	\$27.90 ea.
LED-OS-V10-2*90	Warm White (*WW)	(1) Bell Spot Light & (1) 90° Base / Foot	10" Height	1	1W	\$26.95 ea.
LED-OS-V16-2*90		(1) Bell Spot Light & (1) 90° Base / Foot	16" Height	1	1W	\$27.90 ea.
ADD A SPOT						
LED-OS-401-*	Cool White (*CW)	(1) Modern Spot Light	2-3/8"L x 11/16" Dia.	1	1W	\$17.30 ea.
LED-OS-402-*	Warm White (*WW)	(1) Bell Spot Light	2-1/2"L x 1-1/4" Dia.	1	1W	\$18.70 ea.

For Customizable Parts, See Next Page

OUTWATER PLASTICS INDUSTRIES, INC. • www.outwater.com

Due to raw material cost fluctuations, prices are subject to change.

LED Omni Vertical

Available In: Pre-Fabricated 10" & 16" Lengths
Or Create Your Own Length



Housing Extrusion



LED-OS-400-*: \$2.07 per ft.
4 ft. (*4) & 8 ft. (*8)
Diameter: 1/2"
Material: Aluminum
Finish: Satin Silver Anodized
Designed to receive our 5630 SMD
Rigid Ribbon & Power Track

Rigid Ribbon



LED-PCB2-12-*: \$9.95 ea.
Cool White (*CW) &
Warm White (*WW)
Length: 12"
Trimmable every 2"

In Cool White Or Warm White
12V / 5.4W
Color Temperature:
CW: 6200-6500K /
WW: 2800-3200K
Lumens:
CW: 485 / WW: 450
Beam Spread: 120°

Modern Swivel Spot Light

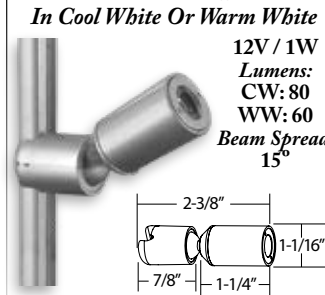

LED-OS-401-*: \$17.30 ea.
Cool White (*CW) &
Warm White (*WW)

In Cool White Or Warm White
12V / 1W
Lumens:
CW: 80
WW: 60
Beam Spread:
15°

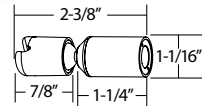

Bell Swivel Spot Light



LED-OS-402-*: \$18.70 ea.
Cool White (*CW) &
Warm White (*WW)

In Cool White Or Warm White
12V / 1W
Lumens:
CW: 80
WW: 60
Beam Spread:
15°

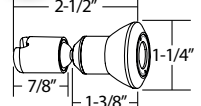

Power Track

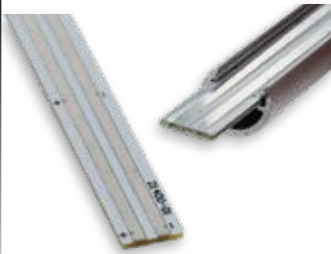

LED-OS-214: \$4.15 ea.
Length: 39"
Works With Any Spot

Frosted Lens



LED-OS-216-*: \$0.75 per ft.
4 ft. (*4) & 8 ft. (*8)

Male End

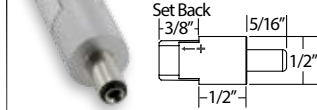

LED-OS-657-*: \$1.55 ea.
Used for power output

Female End

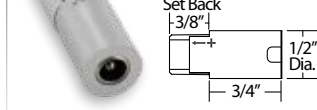

LED-OS-655-*: \$1.55 ea.
Used for power output
Left (*L) & Right (*R)

End Caps

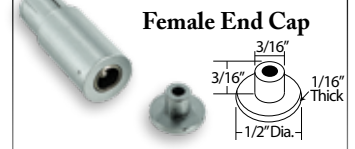

LED-OS-664: \$0.30 ea.

Finishing End Cap

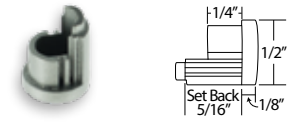

LED-OS-667: \$0.50 ea.
Designed to connect directly to housing

90° Power Foot (Plastic)



LED-OS-654P: \$3.30 ea.

180° Power Foot (Plastic)



LED-OS-655P: \$3.30 ea.

With 60" power cord
For heights over 2 ft. with multiple
spots we recommend metal O-Flange
Cover & Screw Included

Deluxe O-Flange (Metal)

Offers robust screw mounted support and is ideal for use in highly trafficked
vertical or horizontal applications. Can be used on top & bottom.

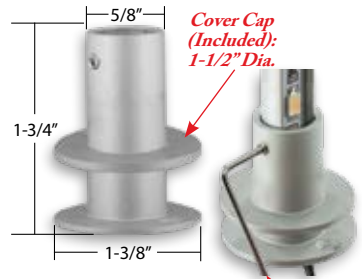

LED-OS-681: \$7.95 ea.
2 Screws Included

Accessories are constructed of nonconductive plastic unless otherwise noted
See Pages 23, For Power Supplies & Accessories

Power Cord With Solderless Clip

Designed to provide power to Rigid
Ribbon Strips housed in the O-Flange.
Comes with Female DC 5.5 and one
Solderless Clip. O-Flange sold separately.



LED-OS-662P: \$2.30 ea.
Length: 60"
Works With
O-Flange

Wall & Stage Perimeter LED Lighting

The LED Omni Wand System can be either utilized for header or stage perimeter lighting.

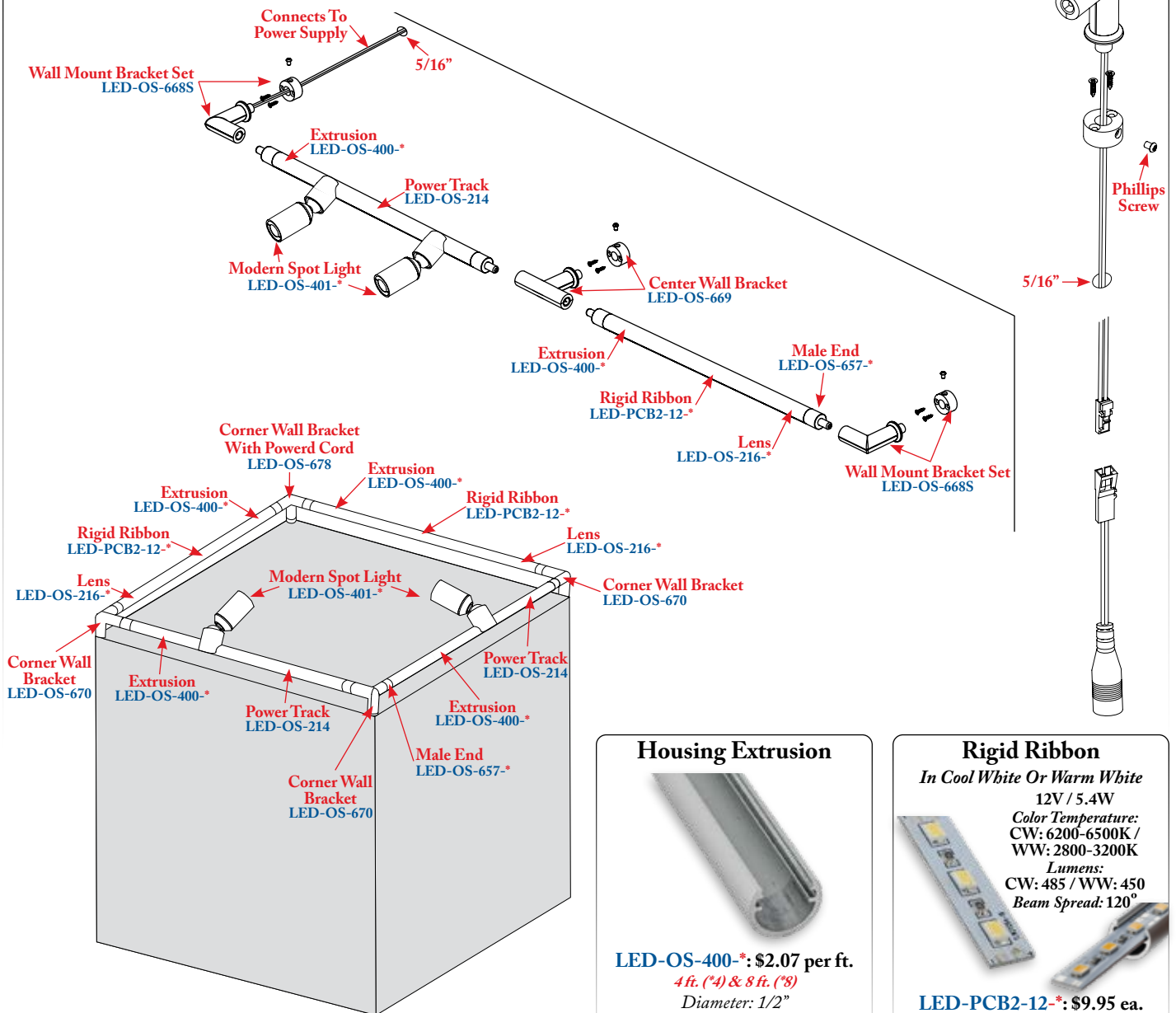

Housing Extrusion



LED-OS-400-*: \$2.07 per ft.
 4 ft. (*4) & 8 ft. (*8)
 Diameter: 1/2"
 Material: Aluminum
 Finish: Satin Silver Anodized
 Designed to receive our 5630 SMD
 Rigid Ribbon & Power Track

Rigid Ribbon

In Cool White Or Warm White
 12V / 5.4W
 Color Temperature:
 CW: 6200-6500K /
 WW: 2800-3200K
 Lumens:
 CW: 485 / WW: 450
 Beam Spread: 120°



LED-PCB2-12-*: \$9.95 ea.
*Cool White (*CW) &
 Warm White (*WW)*
 Length: 12"
 Trimmable every 2"

Accessories are constructed of nonconductive plastic unless otherwise noted
See Pages 23, For Power Supplies & Accessories

Wall & Stage Perimeter LED Lighting

Modern Swivel Spot Light

In Cool White Or Warm White

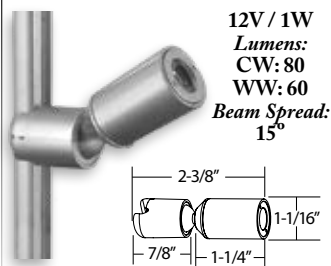

12V / 1W
Lumens:
CW: 80
WW: 60
Beam Spread:
15°

LED-OS-401-*: \$17.30 ea.

*Cool White (*CW) & Warm White (*WW)*

Bell Swivel Spot Light

In Cool White Or Warm White

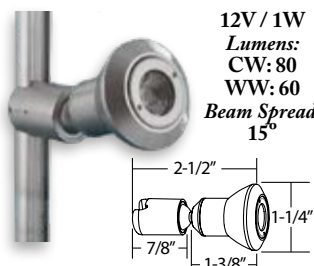

12V / 1W
Lumens:
CW: 80
WW: 60
Beam Spread:
15°

LED-OS-402-*: \$18.70 ea.

*Cool White (*CW) & Warm White (*WW)*

Power Track

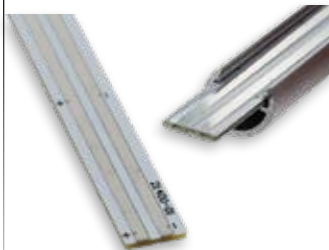

LED-OS-214: \$4.15 ea.

Length: 39"
Works With Any Spot

Solderless Clips



LED-PCB-CLIP: \$1.50 ea.

Effortlessly joins multiple Ribbons and Track

Circuit Bridging Kit



LED-OS-EXT: \$1.99 ea.

Kit includes 2" Trimmable Power Track & 1 Solderless Clip
Kit allows adjustments to 1/16"
See Page 27, For More Info

Frosted Lens



LED-OS-216-*: \$.75 per ft.

*4 ft. (*4) & 8 ft. (*8)*

Male End

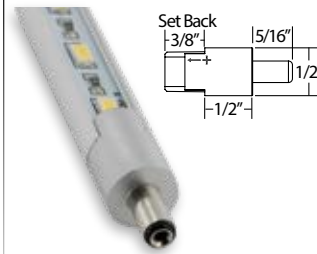

LED-OS-657-*: \$1.55 ea.

*Left (*L) & Right (*R)*
Used for power output

Wall Mount Bracket Set

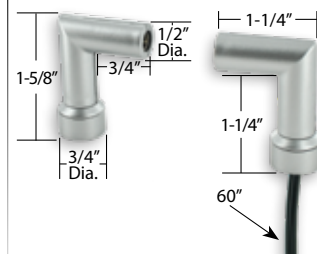

LED-OS-668S: \$8.50 ea.

With 60" power cord
Screws Included

Center Wall Bracket



LED-OS-669: \$3.85 ea.

Screws Included

Corner Wall Bracket With Power Cord



LED-OS-670B: \$6.30 ea.

With 60" power cord
Screws Included

Corner Wall Bracket



LED-OS-670: \$4.40 ea.

Screws Included

All brackets can be mounted vertically or horizontally

Accessories are constructed of nonconductive plastic unless otherwise noted

See Pages 23, For Power Supplies & Accessories

Phone: 1-800-631-8375 • Fax: 1-800-888-3315

Due to raw material cost fluctuations, prices are subject to change.

Glass Shelf LED Lighting

Using standard system components, the LED Omni Wand System can be easily configured for Glass Shelf LED Lighting applications.

Infinitely adjustable and virtually invisible, Glass Shelf LED Lighting enables items to be creatively showcased in a variety of appealing arrangements.

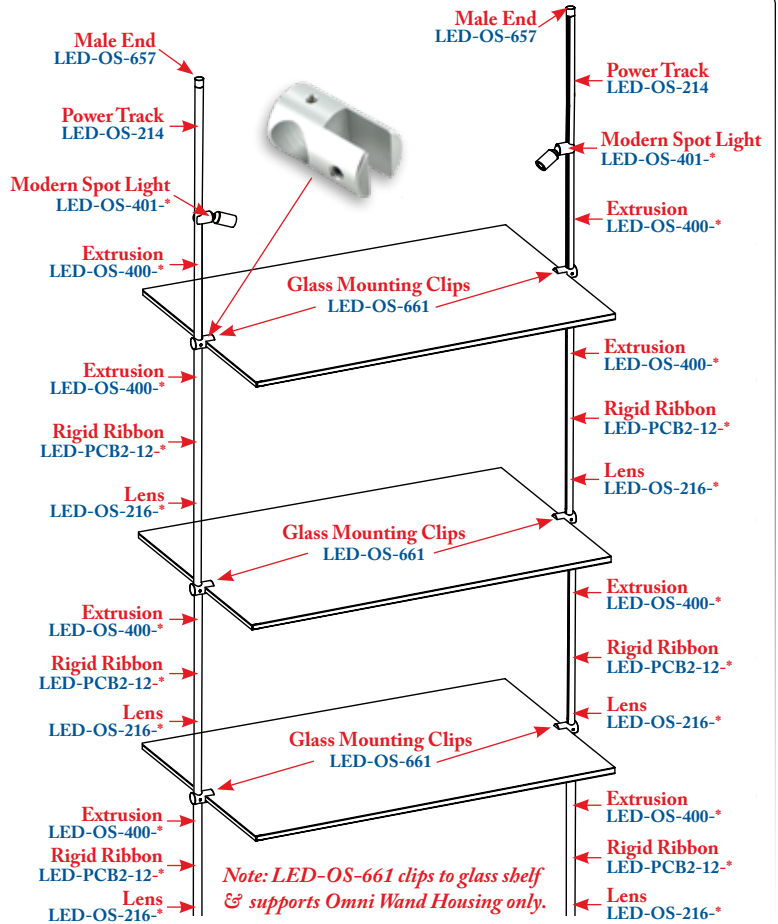

Housing Extrusion



LED-OS-400-*: \$2.07 per ft.
4 ft. (*4) & 8 ft. (*8)

Diameter: 1/2"
Material: Aluminum
Finish: Satin Silver Anodized
Designed to receive our 5630 SMD Rigid Ribbon & Power Track

Rigid Ribbon

In Cool White Or Warm White

12V / 5.4W

Color Temperature:

CW: 6200-6500K /

WW: 2800-3200K

Lumens:

CW: 485 / WW: 450

Beam Spread: 120°



LED-PCB2-12-*: \$9.95 ea.

Cool White (*CW) &
Warm White (*WW)

Length: 12"

Trimmable every 2"

Modern Swivel Spot Light

In Cool White Or Warm White

12V / 1W

Lumens:

CW: 80

WW: 60

Beam Spread:

15°

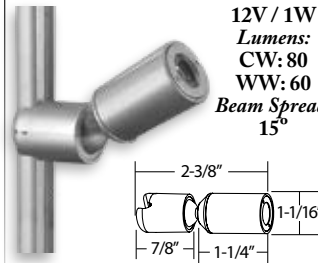

LED-OS-401-*: \$17.30 ea.

Cool White (*CW) &
Warm White (*WW)

Bell Swivel Spot Light

In Cool White Or Warm White

12V / 1W

Lumens:

CW: 80

WW: 60

Beam Spread:

15°

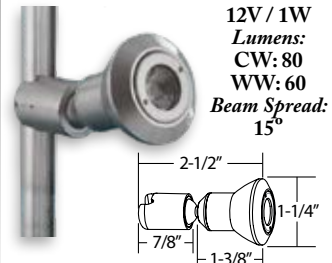

LED-OS-402-*: \$18.70 ea.

Cool White (*CW) &
Warm White (*WW)

Accessories are constructed of nonconductive plastic unless otherwise noted

See Pages 23, For Power Supplies & Accessories

Glass Shelf LED Lighting



Power Track

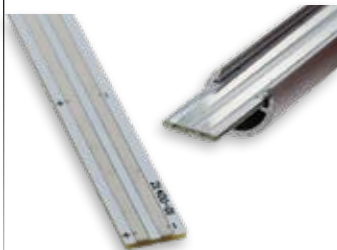

LED-OS-214: \$4.15 ea.
Length: 39"
Works With Any Spot

Solderless Clips



LED-PCB-CLIP: \$1.50 ea.
Effortlessly joins multiple
Ribbons and Track

Circuit Bridging Kit



LED-OS-EXT: \$1.99 ea.
Kit includes 2" Trimmable Power
Track & 1 Solderless Clip
Kit allows adjustments to 1/16"
See Page 27, For More Info

Frosted Lens



LED-OS-216-*: \$0.75 per ft.
4 ft. (*4) & 8 ft. (*8)

Male End



LED-OS-657-*: \$1.55 ea.
Left (*L) & Right (*R)
Used for power output

Male End Cap



LED-OS-663: \$0.30 ea.

Y-Connector

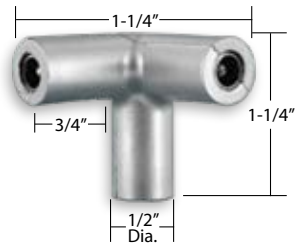

LED-OS-653: \$3.30 ea.

Glass Mounting Clip

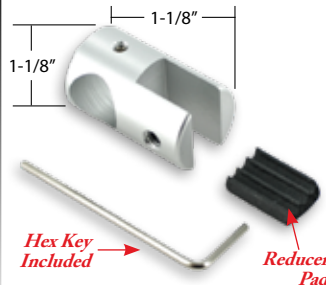

LED-OS-661: \$2.65 ea.
Material: Aluminum
Works With Glass Shelf: 3/16" - 3/8"

90° Foot (Plastic)

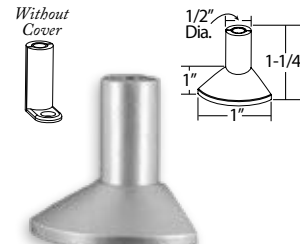

LED-OS-654: \$2.35 ea.
For heights over 2 ft. with multiple
spots we recommend metal O-Flange
Cover & Screw Included

90° Power Foot (Plastic)



LED-OS-654P: \$3.30 ea.
With 60" power cord
For heights over 2 ft. with multiple
spots we recommend metal O-Flange
Cover & Screw Included

Deluxe O-Flange (Metal)

Offers robust screw mounted support and is ideal for use in highly trafficked
vertical or horizontal applications. Can be used on top & bottom.



LED-OS-681: \$7.95 ea.
2 Screws Included

Power Cord With Solderless Clip

Designed to provide power to Rigid
Ribbon Strips housed in the O-Flange.
Comes with Female DC 5.5 and one
Solderless Clip. O-Flange sold separately.



LED-OS-662P: \$2.30 ea.
Length: 60"

Accessories are constructed of nonconductive plastic unless otherwise noted
See Pages 23, For Power Supplies & Accessories

Top Mount LED Lighting

The LED Omni Wand System can also be used as Top Mounted LED Lighting. Utilizing high intensity 5630 SMD chips, the System radiates beautiful unimpeded illumination without shadows or scalloping, lending itself for use as a perfect wall washing light. The System's brackets are extremely durable and comprise all aluminum museum quality construction. The lighting can be mounted either horizontally or vertically and can be pivoted within its housing to direct the lighting where it is required.

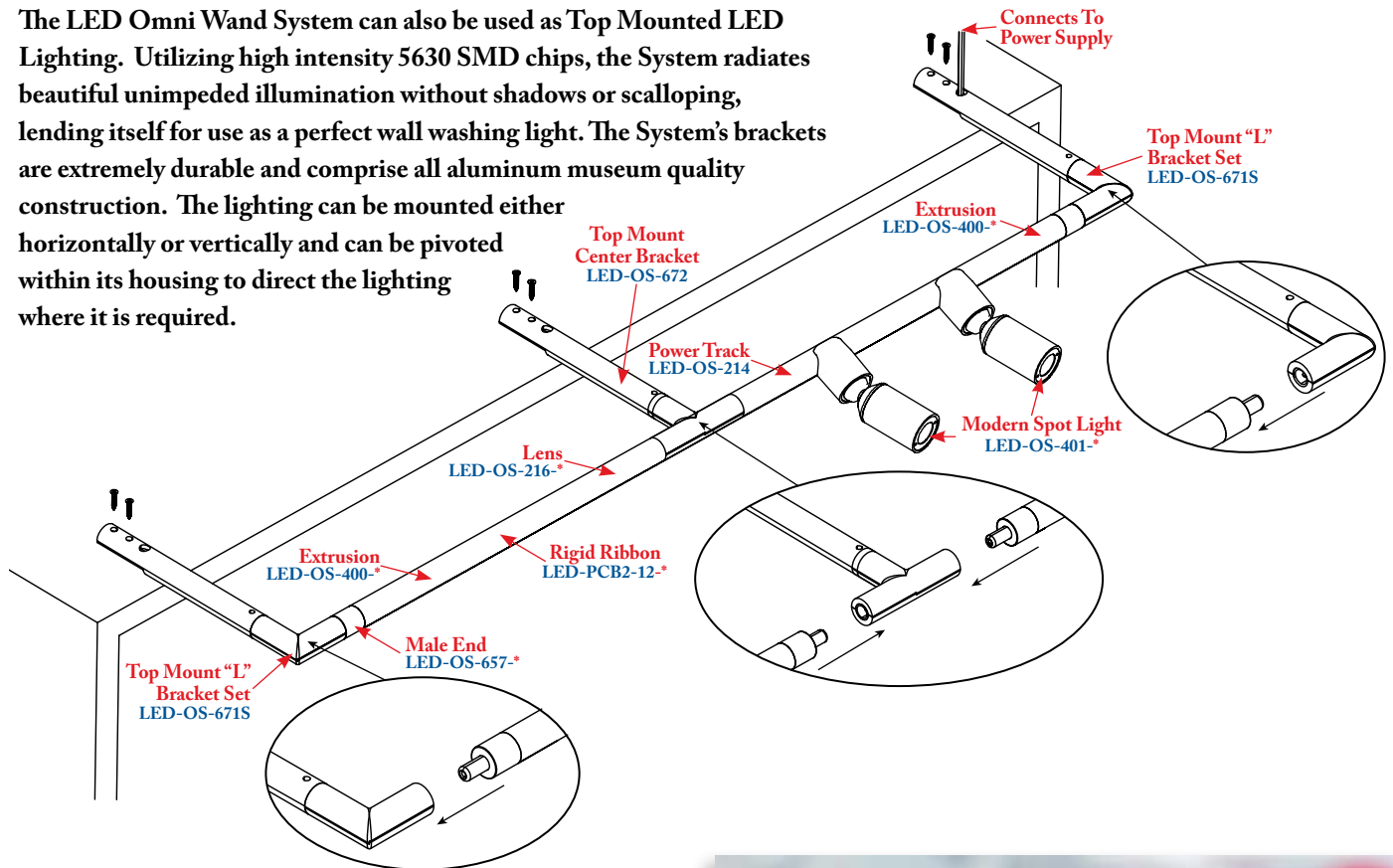

Accessories are constructed of nonconductive plastic unless otherwise noted
See Pages 23, For Power Supplies & Accessories

OUTWATER PLASTICS INDUSTRIES, INC. • www.outwater.com

Due to raw material cost fluctuations, prices are subject to change.

Top Mount LED Lighting

Housing Extrusion



LED-OS-400-*: \$2.07 per ft.
*4 ft. (*4) & 8 ft. (*8)*
 Diameter: 1/2"
 Material: Aluminum
 Finish: Satin Silver Anodized
 Designed to receive our 5630 SMD
 Rigid Ribbon & Power Track

Rigid Ribbon



LED-PCB2-12-*: \$9.95 ea.
*Cool White (*CW) & Warm White (*WW)*
 Length: 12"
 Trimmable every 2"

Modern Swivel Spot Light

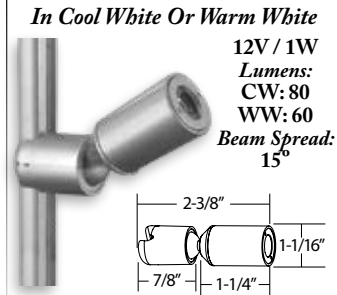

LED-OS-401-*: \$17.30 ea.
*Cool White (*CW) & Warm White (*WW)*

Bell Swivel Spot Light



LED-OS-402-*: \$18.70 ea.
*Cool White (*CW) & Warm White (*WW)*

Power Track

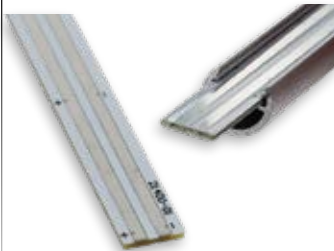

LED-OS-214: \$4.15 ea.
 Length: 39"
 Works With Any Spot

Solderless Clips



LED-PCB-CLIP: \$1.50 ea.
 Effortlessly joins multiple
 Ribbons and Track

Circuit Bridging Kit



LED-OS-EXT: \$1.99 ea.
 Kit includes 2" Trimmable Power
 Track & 1 Solderless Clip
 Kit allows adjustments to 1/16"
 See Page 27, For More Info

Frosted Lens



LED-OS-216-*: \$0.75 per ft.
*4 ft. (*4) & 8 ft. (*8)*

Male End

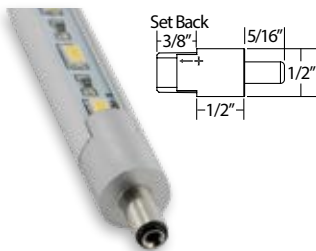

LED-OS-657-*: \$1.55 ea.
*Left (*L) & Right (*R)*
 Used for power output

Top Mount "L" Bracket Set

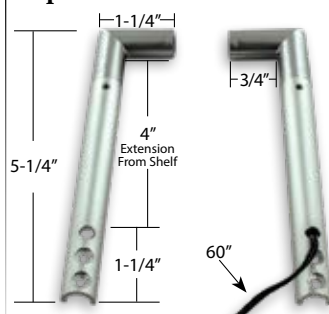

LED-OS-671S: \$10.35 set
 With 60" power cord
 Screws Included

Top Mount Center Bracket

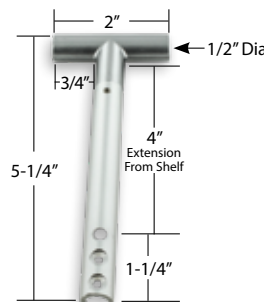

LED-OS-672: \$4.40 ea.
 Screws Included

Accessories are constructed of nonconductive plastic unless otherwise noted
 See Pages 23, For Power Supplies & Accessories

Omni Wand Sample Kit

Experience the LED Omni Wand System for yourself! This fully functional "plug & play" sample kit comes complete with a power supply and everything you will need to come to appreciate this unprecedented, extremely versatile lighting system!



KIT INCLUDES



A

18" Omni Wand Housing Extrusion

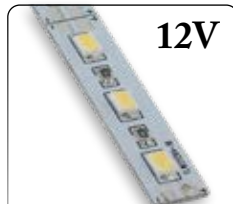

B

6" Cool White Rigid Ribbon Strip (5630 SMD Chip)



C

6" Power Track



D

Bell/Modern Style Spots: Cool White (1) & Warm White (1)



E

Solderless Clips (2)



F

6" Warm White Rigid Ribbon Strip (5630 SMD Chip)



G

Female End (1) & Male End (1)



H

Mounting Clips (2) With Screws

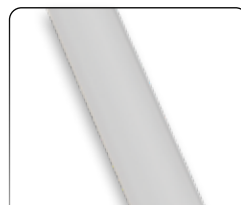

Frosted Lens



12V Power Supply

Constant Voltage

DC 5.5

Accessories For Omni System



1A & 3A Power Supply (Required)

LED-12V-1A
\$8.95 ea.

2.91"L x 1.61"W x 1.14"H
1A / 12V / 12W
Output Cord: 72"
Color: Black



LED-12V-3A
\$16.15 ea.

3.41"L x 2.31"W x 1.26"H
3A / 12V / 36W
Output Cord: 72"
Color: Black



DC 5.5



36W



LED-SWITCH-3A/6A: \$4.50 ea.

Function: On/Off
1"W x 3/4"H x 2-1/4"L
Female Input Cord: 12"
Male Output Cord: 12"
With DC5.5

Switches (Optional)



LED-OS-648A
\$9.00 ea.

Function:

- Touch once to turn on
- Touch again to turn off

22mm Dia. x 16mm W
24 Watts Max
Female Input Cord: 18"
Male Output Cord: 18"
Mounting: Recessed
With DC5.5



Door Sensor (Optional)

Can Be Used For Both
Surface Mounting or Recessed Mounting

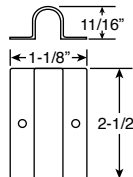

LED-DSEN
\$11.75 ea.

2-1/2"L x 1-1/8"W x 11/16"H
24 Watt Max
Female Input Cord: 18"
Male Output Cord: 18"
Color: Silver
With DC5.5

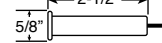

Dimmer (Optional)



LED-INLINE-DIM: \$5.95 ea.

1-3/8"W x 1"H x 2-5/8"L
Female Input Cord: 24"
Male Output Cord: 24"
Range of Dimming: 0-100%
Mounting: Adhesive
With DC5.5

Touch Dimmer (Optional)

22mm Dia. x 16mm W
24 Watts Max
Female Input Cord: 18"
Male Output Cord: 18"
Range of Dimming: 0-100%
Mounting: Recessed
With DC5.5



















Standard Touch Dimmer







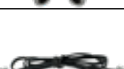











LED-DIM-648D: \$9.00 ea.

Function:

- Touch once (for one half second) to turn on
- Touch (more than one half second) to gradually adjust the light low to high
- Tap again (for one half second) to turn off

Quick Reference

	Part Number	Description	Dimension	Price
	LED-OS-400-*	Housing Extrusion	4' (*4) & 8' (*8) Lengths	\$2.07 per foot
	LED-PCB2-12-*	Rigid Ribbon Cool White (*CW) & Warm White (*WW)	12" Lengths (Cutttable Every 2")	\$11.25 ea.
	LED-OS-401-*	Modern Spot Light Cool White (*CW) & Warm White (*WW)	2-3/8" W x 1-1/16" H	\$17.30 ea.
	LED-OS-402-*	Bell Spot Light Cool White (*CW) & Warm White (*WW)	2-1/2" W x 1-1/4" H	\$18.70 ea.
	LED-OS-214	Power Track	39' Lengths	\$4.15 ea.
	LED-PCB-CLIP	Solderless Clips	-	\$1.50 ea.
	LED-OS-EXT	Circuit Bridging Kit	2" Lengths	\$1.99 ea.
	LED-OS-216-*	Frosted Lens	4' (*4) & 8' (*8) Lengths	\$.75 per foot
	LED-OS-665-*	Female End Left (*L) & Right (*R)	3/4" W x 1/2" Dia. (Lens Set Back: 3/8")	\$1.55 ea.
	LED-OS-664	Female End Cap	1/2" Dia.	\$30 ea.
	LED-OS-657-*	Male End Left (*L) & Right (*R)	1/2" W x 1/2" Dia. (Lens Set Back: 3/8")	\$1.55 ea.
	LED-OS-663	Male End Cap	1/2" W x 1/2" Dia.	\$30 ea.
	LED-OS-667	Finished End Cap	1/8" W x 1/2" Dia. (Lens Set Back: 5/16")	\$.50 ea.
	LED-OS-223	Female/Female Connecting Cable	6" Long Cord / 7-7/8" Overall	\$2.95 ea.
	LED-OS-222 (6-3/4") LED-OS-24 (24") LED-OS-30 (30") LED-OS-48 (48")	Female/Male Connecting Cable	Lengths: 6-3/4", 24", 30" & 48"	\$2.95 ea. \$3.25 ea. \$3.50 ea. \$3.75 ea.
	LED-OS-651	T-Connector	2" W x 1-1/4" H x 1/2" Dia.	\$3.45 ea.
	LED-OS-652	L-Connector	1-1/4" W x 1-1/4" H x 1/2" Dia.	\$2.50 ea.

	Part Number	Description	Dimension	Price
	LED-OS-653	Y-Connector	1-1/4" W x 1-1/4"H x 1/2" Dia.	\$3.30 ea.
	LED-OS-666	U-Connector	1-1/2" W x 1-1/8"H x 1/2" Dia.	\$2.50 ea.
	LED-OS-650	Straight Connector	2" W x 1/2" Dia.	\$2.50 ea.
	LED-OS-654	90° Foot	1" W x 1-1/4"H x 1/2" Dia.	\$2.35 ea.
	LED-OS-654P	90° Power Foot	1" W x 1-1/4"H x 1/2" Dia. 60" (1.5M) Power Cord	\$3.30 ea.
	LED-OS-655	180° Foot	1-9/16" W x 1-1/4"H x 1/2" Dia.	\$2.35 ea.
	LED-OS-655P	180° Power Foot	1-9/16" W x 1-1/4"H x 1/2" Dia. 60" (1.5M) Power Cord	\$3.30 ea.
	LED-OS-671S	Top Mount "L" Bracket Set	1-1/4" W x 5-1/4"H x 1/2" Dia. 60" (1.5M) Power Cord	\$10.35 ea.
	LED-OS-672	Top Mount Center Bracket	2" W x 5-1/4"H x 1/2" Dia.	\$4.40 ea.
	LED-OS-668S	Wall Mount Bracket Set	1-1/4" W x 1-5/8"H 60" (1.5M) Power Cord	\$8.50 ea.
	LED-OS-669	Center Wall Bracket	2" W x 1-5/8"H	\$3.85 ea.
	LED-OS-670B	Corner Wall Bracket With Power Cord	1-1/4" W x 1-5/8"H 60" (1.5M) Power Cord	\$6.30 ea.
	LED-OS-670	Corner Wall Bracket	1-1/4" W x 1-5/8"H	\$4.40 ea.
	LED-OS-681	Deluxe O-Flange With Cover Cap (Hex Included)	Collar: 1-3/4" H x 5/8 Dia. x 1-3/8" Dia. Cover Cap: 1-1/2" Dia.	\$7.95 ea.
	LED-OS-662P	Power Cord With Solderless Clip	60" (1.5M) Power Cord	\$2.30 ea.
	LED-OS-676	Mounting Clip With Screw	-	\$.35 ea.
	LED-OS-660	Standoff Mounting Clip	7/16" W x 3/4" H	\$3.45 ea.
	LED-OS-661	Glass Mounting Clip	1-1/8" W x 1-1/8" H	\$2.65 ea.

How To Measure

Set Backs

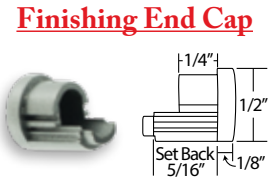
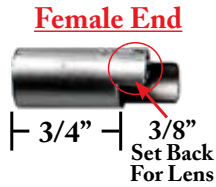

In This Example Our Finished Fixture Size is 32"

A. For Fixtures With A Female End & Finishing End Cap

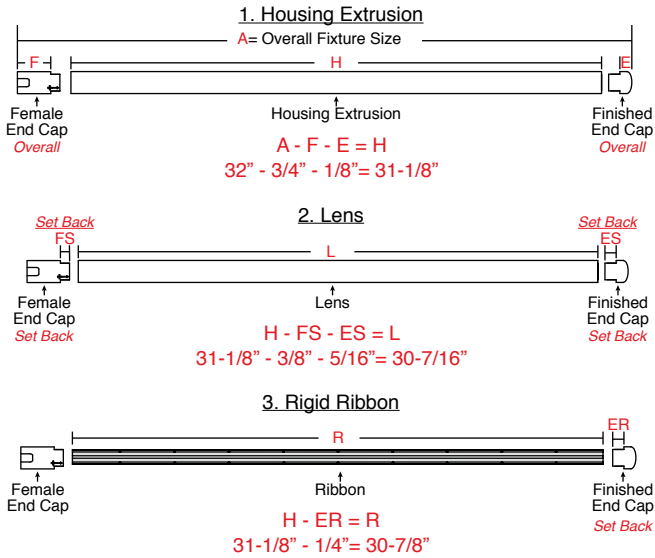

B. For Fixtures With Two Female Ends

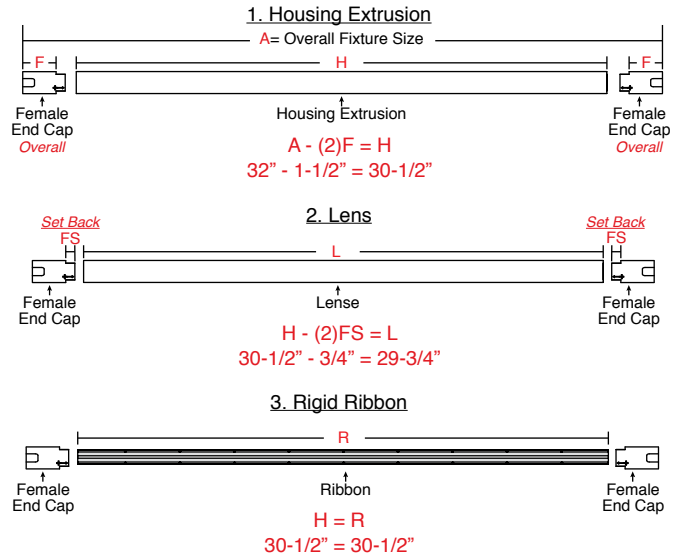

Note: Ribbon can only be trimmed in 2" increments. Use the circuit bridging kit (LED-OS-EXT) to complete circuit for next lighting fixture.

C. For Fixtures With A Female End & Male End

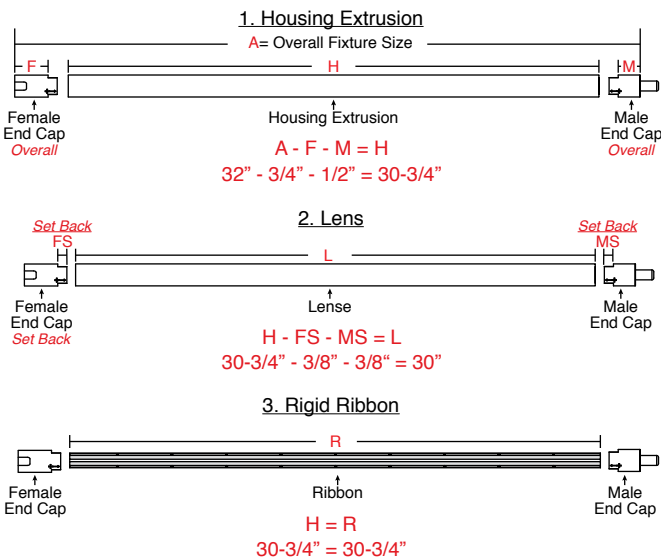

Note: Ribbon can only be trimmed in 2" increments. Use the circuit bridging kit (LED-OS-EXT) to complete circuit for next lighting fixture.

D. For Fixtures With Two Male Ends

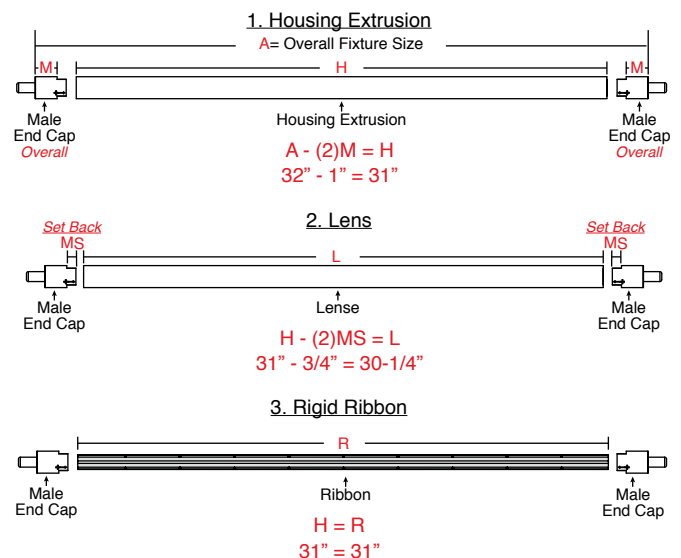

Note: Ribbon can only be trimmed in 2" increments. Use the circuit bridging kit (LED-OS-EXT) to complete circuit for next lighting fixture.

Polarity Matters

Rigid Ribbon

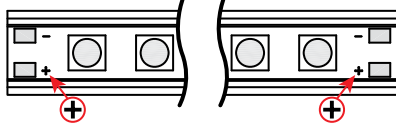

Power Track

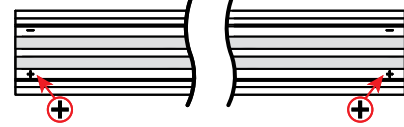

Female & Male End (Left)

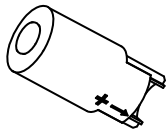

LED-OS-665-L

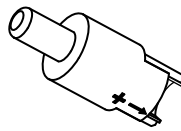

LED-OS-657-L

Female & Male End (Right)

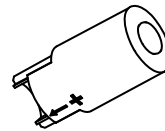

LED-OS-665-R

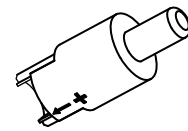

LED-OS-657-R

Always Face The Positive (+) Side Towards The Assembler

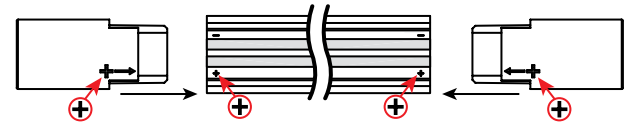
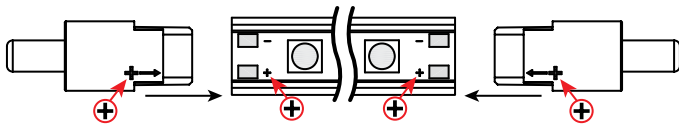

GOOD

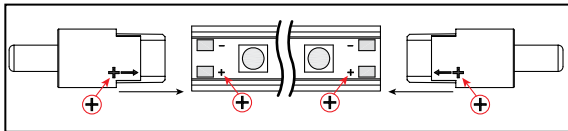

BAD

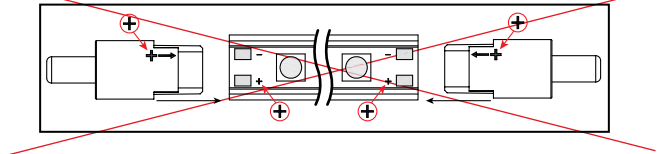

Circuit Bridging Kit

Circuit Bridge Kit includes
2" Trimmable Power Track & 1 Solderless Clip

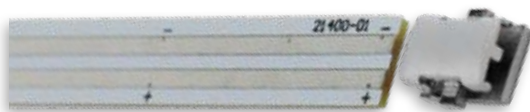

Kit allows you to complete circuit connection



"Acts like an extension cord"

Power Track can be trimmed to size
Allows adjustments up to 1/16"



Enables circuit connection between
LED Ribbon Light and Male/Female Ends



Visit Our Website

www.outwater.com

Shop
Online

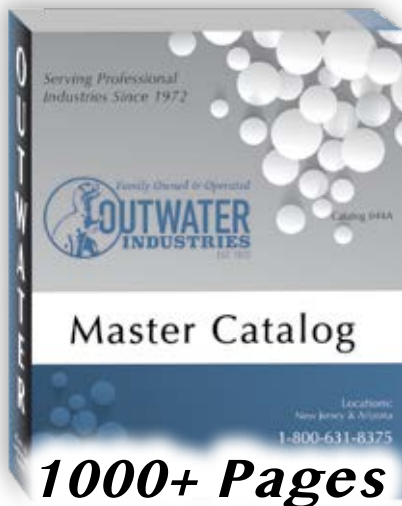

Request a *FREE* Catalog

REQUEST FORM- CATALOG 44A

NAME: _____

COMPANY NAME: _____

ADDRESS: _____

CITY: _____

STATE: _____ ZIP CODE: _____

Code: OMNI20